

**Development of a Bidentate Lewis Acid Catalyzed Inverse Electron
Demand Diels-Alder Reaction of 1,2-Diazines for the Synthesis of
Substituted Arenes**

Inauguraldissertation

zur Erlangung der Würde eines

Doktors der Philosophie

vorgelegt der

Philosophisch-Naturwissenschaftlichen Fakultät der Universität Basel

von

Simon Niklaus Kessler

aus

Schuders-Schiers (GR), Schweiz

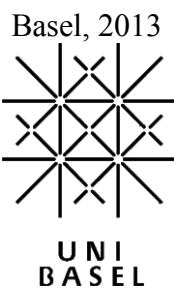

Originaldokument gespeichert auf dem Dokumentenserver der Universität Basel

edoc.unibas.ch



Dieses Werk ist unter dem Vertrag „Creative Commons Namensnennung-Keine kommerzielle
Nutzung-Keine Bearbeitung 2.5 Schweiz“ lizenziert. Die vollständige Lizenz kann unter

creativecommons.org/licences/by-nc-nd/2.5/ch

eingesehen werden.

Genehmigt von der Philosophisch-Naturwissenschaftlichen Fakultät auf Antrag von:

Prof. Dr. Andreas Pfaltz

PD Dr. Hermann Wegner

Basel, den 11.12.2012

Prof. Dr. Jörg Schibler

Dekan



Namensnennung-Keine kommerzielle Nutzung-Keine Bearbeitung 2.5 Schweiz

Sie dürfen:



das Werk vervielfältigen, verbreiten und öffentlich zugänglich machen

Zu den folgenden Bedingungen:



Namensnennung. Sie müssen den Namen des Autors/Rechteinhabers in der von ihm festgelegten Weise nennen (wodurch aber nicht der Eindruck entstehen darf, Sie oder die Nutzung des Werkes durch Sie würden entlohnt).



Keine kommerzielle Nutzung. Dieses Werk darf nicht für kommerzielle Zwecke verwendet werden.



Keine Bearbeitung. Dieses Werk darf nicht bearbeitet oder in anderer Weise verändert werden.

- Im Falle einer Verbreitung müssen Sie anderen die Lizenzbedingungen, unter welche dieses Werk fällt, mitteilen. Am Einfachsten ist es, einen Link auf diese Seite einzubinden.
- Jede der vorgenannten Bedingungen kann aufgehoben werden, sofern Sie die Einwilligung des Rechteinhabers dazu erhalten.
- Diese Lizenz lässt die Urheberpersönlichkeitsrechte unberührt.

Die gesetzlichen Schranken des Urheberrechts bleiben hiervon unberührt.

Die Commons Deed ist eine Zusammenfassung des Lizenzvertrags in allgemeinverständlicher Sprache: <http://creativecommons.org/licenses/by-nc-nd/2.5/ch/legalcode.de>

Haftungsausschluss:

Die Commons Deed ist kein Lizenzvertrag. Sie ist lediglich ein Referenztext, der den zugrundeliegenden Lizenzvertrag übersichtlich und in allgemeinverständlicher Sprache wiedergibt. Die Deed selbst entfaltet keine juristische Wirkung und erscheint im eigentlichen Lizenzvertrag nicht. Creative Commons ist keine Rechtsanwaltsgesellschaft und leistet keine Rechtsberatung. Die Weitergabe und Verlinkung des Commons Deeds führt zu keinem Mandatsverhältnis.

*...Dass ich erkenne, was die Welt
Im Innersten zusammenhält...*

–JWG, Faust I

This thesis was supervised by PD Dr. Hermann A. Wegner from October 2008 to November 2012 at the University of Basel.

Parts of this work have been previously published:

„*Lewis Acid Catalyzed Inverse Electron-Demand Diels-Alder Reaction of 1,2-Diazines*“

Kessler, S. N., Wegner, H. A. *Org. Lett.* **2010**, *12*, 4062-4065.

„*Bidentate Lewis Acids for the Activation of 1,2-Diazines – a New Mode of Catalysis*“

Kessler S. N.; Neuburger, M.; Wegner, H. A. *Eur. J. Org. Chem.* **2011**, 3238-3245.

„*Bidentate Lewis Acids for the Activation of 1,2-Diazines in Organic Synthesis*“

Wegner H. A., Kessler S. N. *Synlett* **2012**, 699-705.

„*One-Pot Procedure for the Synthesis of Substituted Pyridazin-Annulated Aromatics*“

Kessler S. N., Wegner H. A., *Org. Lett.* **2012**, *14*, 3268-3271.

(Highlighted by Kocienski P, *Synfacts* **2012**, *8*, 1048.)

“*Bidentate Lewis Acid Catalyzed Inverse-Electron-Demand Diels-Alder Reaction for the Selective Functionalization of Aldehydes*”

Schweighauser L., Bodoky I., Kessler S. N., Häussinger D., Wegner H. A. *Synthesis* **2012**, *44*, 2195-2199.

“*Domino Inverse Electron-Demand Diels–Alder/Cyclopropanation Reaction of Diazines Catalyzed by a Bidentate Lewis Acid*”

Kessler S. N.; Neuburger, M.; Wegner, H. A. *J. Am. Chem. Soc.* **2012**, *134*, 17885-17888.

Acknowledgements

First of all, I would like to thank my supervisor, PD Dr. Hermann Wegner for the possibility to work in his research group perusing a very interesting project and constantly being further educated in the understanding of organic chemistry. I appreciate a lot, the fruitful discussions and the perpetual support he provided in any matter, to all times.

I am very thankful to Prof. Dr. Andreas Pfaltz for advising and examine this thesis and to Prof. Dr. Karl Gademann for chairing the examination.

Special thanks go to my former labmates Mathieu Auzias and Silvia Bellotto and to the rest of the former and present group members, Anne-Florence Stoessel, Jonathan Basler, Luca Schweighauser, Giovanni Pietro Rachiero, Raphael Reuter and Miroslav Sisa for creating a pleasant atmosphere both during and after work.

I like to thank a lot the students Ina Bodoky, Patrick Wehrli and Samuel Bader for having had the pleasure to advice them during their master thesis and for their contribution to this thesis.

Also, I would like to thank all the other students, Annika Büttner, Daniel Ebner, Stefanie Geigle and Viktor Hoffmann who did their practical course under my guidance.

As well, I thank all the other colleagues in the Chemistry department with whom I shared some memorable time.

Furthermore, I am thankful to Dr. Heinz Nadig, Dr. Markus Neuburger Sylvie Mittelheisser Werner Kirsch, and Daniel Häussinger for their analytical measurements and their great support.

I thank my dearest Uli for the understanding and support, especially during the final spurt of my thesis.

Im Speziellen, bin ich meinen Eltern Esther und Jakob unheimlich dankbar für Ihre unablässige und bestmögliche Unterstützung auf meinem ganzen bisherigen Lebensweg.

Financial support of the Swiss National Science Foundation and the award of a Novartis fellowship in Organic Chemistry is gratefully acknowledged.

Table of Contents

| | | |
|-------|---|----|
| 1 | Introduction | 1 |
| 1.1 | Mechanism of the Diels-Alder reaction | 2 |
| 1.2 | Hetero Diels-Alder reaction | 5 |
| 1.3 | Retro Diels-Alder reaction | 8 |
| 1.4 | Inverse electron demand Diels-Alder reaction..... | 10 |
| 1.4.1 | Inverse electron demand Diels-Alder reaction of aza-heteroaromatics | 11 |
| 1.4.2 | Inverse electron demand Diels-Alder reaction of tetrazines | 12 |
| 1.4.3 | Inverse electron demand Diels-Alder reaction of triazines | 14 |
| 1.4.4 | Inverse electron demand Diels-Alder reaction of diazines | 15 |
| 1.5 | Lewis acid catalysis..... | 19 |
| 1.5.1 | Lewis acids in the Diels-Alder reaction | 20 |
| 1.5.2 | Bifunctional Lewis acids in catalysis | 22 |
| 1.6 | References | 25 |
| 2 | Objectives of the Thesis | 31 |
| 3 | Results and Discussion..... | 32 |
| 3.1 | The development of a catalyst for the IEDDA reaction of 1,2-diazines..... | 32 |
| 3.1.1 | Introduction | 32 |
| 3.1.2 | Synthesis of the bidentate Lewis acid catalyst..... | 35 |
| 3.1.3 | Scope of the bidentate Lewis acid catalyzed IEDDA reaction of 1,2-diazines.. | 39 |
| 3.1.4 | Mechanistic considerations | 51 |
| 3.2 | One-pot synthesis of phthalazines and pyridazino-aromatics..... | 52 |
| 3.2.1 | Introduction | 52 |
| 3.2.2 | Optimization of reaction conditions..... | 55 |
| 3.2.3 | Scope of the one-pot reaction for the synthesis of phthalazines | 56 |
| 3.2.4 | Scope of the one-pot reaction for the synthesis of pyridazino-aromatics | 59 |
| 3.3 | A novel two-step strategy for the synthesis of substituted naphthalenes..... | 60 |

| | | |
|-------|--|-----|
| 3.3.1 | Application for the synthesis of Naproxen..... | 60 |
| 3.3.2 | Application for the synthesis of silylnaphthalenes..... | 61 |
| 3.4 | Catalyzed domino IEDDA/cyclopropanation reaction of diazines..... | 63 |
| 3.4.1 | Introduction..... | 63 |
| 3.4.2 | Scope of the catalyzed domino IEDDA/cyclopropanation reaction..... | 65 |
| 3.4.3 | Mechanistic considerations..... | 70 |
| 3.4.4 | Enantioselective catalysis in the IEDDA/[9,3]-sigmatropic rearrangement..... | 74 |
| 3.5 | Catalyzed domino IEDDA/[1,9]-sigmatropic rearrangement of diazines..... | 76 |
| 3.5.1 | Mechanistic considerations..... | 77 |
| 3.6 | Development of an air stable catalyst for the IEDDA reaction..... | 80 |
| 3.7 | References..... | 83 |
| 4 | Summary and Conclusion..... | 91 |
| 5 | Experimental Part..... | 95 |
| 5.1 | General information..... | 95 |
| 5.3 | Second generation preparation of 5,10-dimethyl-5,10-dihydroboranthrene..... | 98 |
| 5.4 | Complexation experiment..... | 101 |
| 5.5 | Bidentate Lewis acid catalyzed IEDDA reaction..... | 102 |
| 5.6 | One-pot synthesis of phthalazines and pyridazino-aromatics..... | 129 |
| 5.7 | Two step synthesis of substituted naphthalenes..... | 151 |
| 5.8 | Domino IEDDA/cyclopropanation reaction..... | 154 |
| 5.9 | Domino IEDDA/[1,9]-sigmatropic rearrangement..... | 177 |
| 5.10 | Calculations..... | 180 |
| 5.11 | References..... | 199 |
| 6 | Appendix..... | 201 |
| 6.1 | Abbreviations..... | 201 |
| 6.2 | Curriculum vitae: Simon N. Kessler..... | 203 |

1 Introduction

The Diels-Alder (DA) reaction, first described in 1928 by Otto Diels and Kurt Alder¹ and acknowledged with the Nobel Prize in 1950, involves the reaction of a diene **A** with a dienophile **B** to form a six-membered ring **C** (Scheme 1). By the exchange of any of the carbon atoms a-f with a hetero atom it becomes a hetero Diels-Alder reaction.² And therefore what one often meets is the main classification into a DA and hetero DA reaction. In concern of my work it is more illustrative to categorize into a (normal) DA and an inverse electron demand Diels-Alder (IEDDA) reaction on the basis of the FMO theory (Figure 1).

Scheme 1. Diels-Alder reaction.

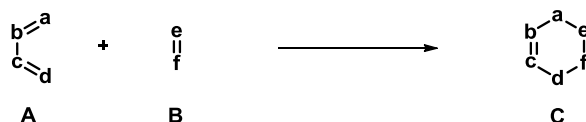

Today, the Diels-Alder reaction is one of the most powerful synthetic method both intensively applied in academia as well as in industry.³ Despite the age of the Diels-Alder reaction, by the simultaneous formation of two single bonds in a very controlled manner with high atomic economy, it meets more than ever the definition of a modern synthetic transformation. Also nature uses the Diels-Alder reaction, for example first postulated in 1980 by Black et al.⁴ for the biosynthesis of endiandric acids and 1982 confirmed by Nicolaou et al.⁵ by biomimetic synthesis (Scheme 2).

Scheme 2. Biomimetic Diels-Alder key-step in the total synthesis of endiandric acid by Nicolaou.

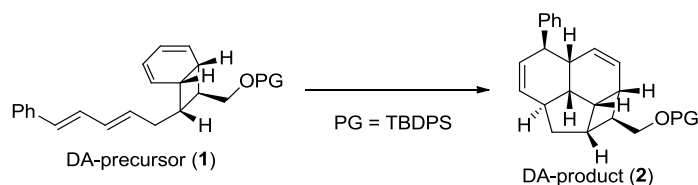

Recently, the question arose if nature also makes use of so called Diels-Alderase as a catalyst to overcome non-spontaneous cycloaddition reactions.⁶ Different reports appeared on the catalysis of Diels-Alder reactions by artificial antibodies or ribonucleic acid (RNA).⁷ Eventually the long sought Diels-Alderase was found in the biosynthesis of spinosyn A (Scheme 3).⁸ However, it is stated that a stepwise [4+2]-cycloaddition cannot be ruled out at present.

Scheme 3. Diels-Alder reaction catalyzed by cyclase SpnF in the biosynthesis of spinosyn A.

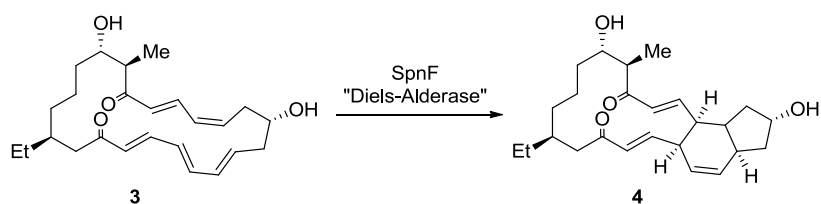

In spite of nature's supremacy also in this field, chemists intensively studied the catalysis and stereoselective catalysis of the Diels-Alder reaction.^{9–12}

1.1 Mechanism of the Diels-Alder reaction

As defined by the Woodward-Hoffmann rules the Diels-Alder reaction is a symmetry allowed suprafacial-suprafacial [4+2]-cycloaddition.¹³ One of the simplest and most successful methods to describe the mechanistics of the Diels-Alder reaction in more detail was found in the frontier molecular orbital (FMO) theory.¹⁴ The interaction of reactants was mathematically described by Klopman¹⁵ and Salem¹⁶ derived from the perturbation theory. The third term of the Klopman-Salem (KS) equation describes the interaction of occupied with unoccupied molecular orbitals (MO) of reactants, whereas the most important orbitals are the frontier molecular orbitals (FMO) as recognized by Fukui.¹⁷ The simplified third term of the KS equation (Eq. 1) can also be used to describe Diels-Alder reactions.^{18–21}

$$\Delta E \approx K \left[\frac{1}{E_{HOMO}(\text{diene}) - E_{LUMO}(\text{dienophile})} + \frac{1}{E_{HOMO}(\text{dienophile}) - E_{LUMO}(\text{diene})} \right] \quad (\text{Eq. 1})$$

This equation can be even further simplified by focusing on the dominant FMO interactions (Eq. 2).

$$\Delta E \approx \frac{1}{E_{HOMO} - E_{LUMO}} \quad (\text{Eq. 2})$$

According to this description (Eq. 2), the [4+2]-cycloaddition is generally divided into three modes by considering substituent effects on diene and dienophile.^{19–21} The DA reaction can be classified by the strongest interacting FMO's into a normal and an inverse electron demand DA reaction (Figure 1). If both energy terms in Equation 1 are equal the reaction is called a neutral DA reaction.

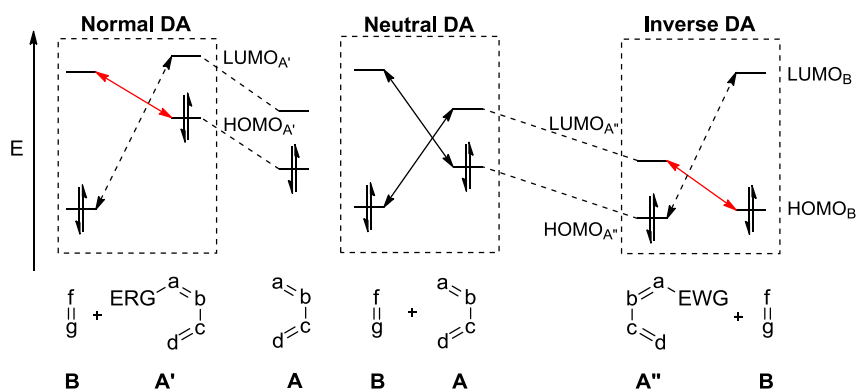

Figure 1. Different classes of DA reactions by their electron demand. Red arrow denominates main interactions

As described above, the best interaction arises from the overlap of the FMO's, which are closest in energy. Thus, in the most common, the normal DA reaction the major energy contribution stems from the overlap of the diene's HOMO with the dienophile's LUMO and vice versa in case of the inverse electron demand DA reaction. The influence of substituents on the dienophile was described by Houk^{19,20} as following:

-Electron releasing groups (ERG), increase both the HOMO and the LUMO energies, the former more than the later and the unsubstituted HOMO coefficient is larger than the substituted one.

-Electron withdrawing groups (EWG), decrease HOMO and LUMO energies, the later more than the former and the unsubstituted coefficient is larger than the substituted one in both the LUMO and the HOMO but the difference of coefficients is greater in the LUMO.

The substituent effects can be reasoned in the same manner for dienes as calculated by Houk (Figure 2).¹⁹

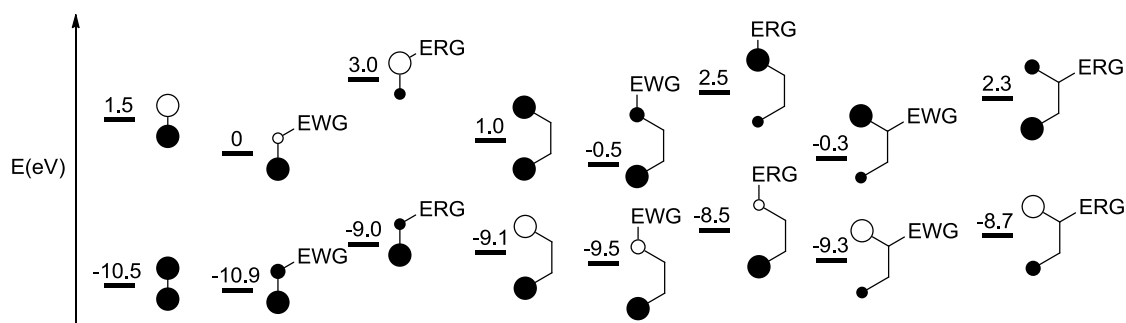
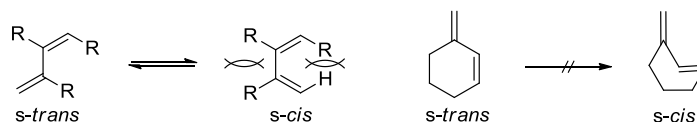

Figure 2. MO coefficients of dienophiles and dienes substituted with ERG or EWG, by Houk.¹⁹

An essential prerequisite in the DA reaction is the *s-cis* conformation of the diene which, if congested or not possible by constraints, slows down or does not allow a DA reaction to proceed (Scheme 4).^{22,23}

Scheme 4. Steric or structural constraints in the *s-cis/s-trans* isomerisation of dienes.



The *ortho*, *meta* and *trans* regioselectivity of a DA reaction was as well described using the perturbation theory.^{19,20} For this reason the frontier molecular orbital coefficients have been taken into account. The preferred sites of interaction of HOMO-LUMO are those of similar orbital coefficients. A high orbital coefficient of the HOMO reacts with the high orbital coefficient of the LUMO and the same is valid for small MO coefficients (Scheme 5).

Scheme 5. *Ortho*, *meta*, *para* regioselectivity of the DA reaction.

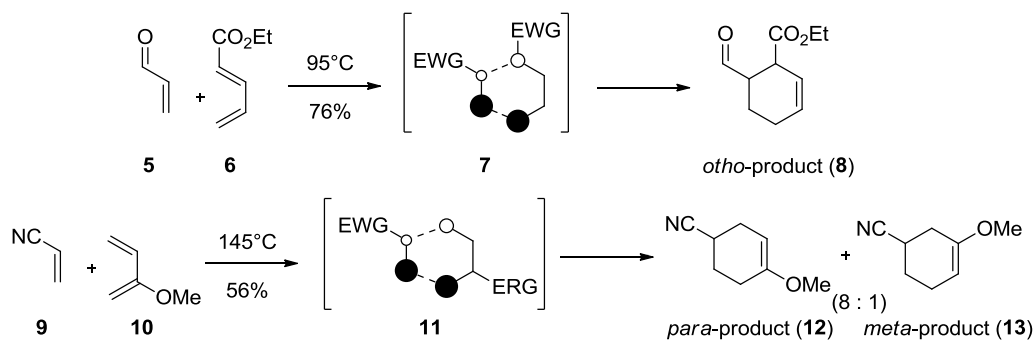

The diastereoselectivity of the DA reaction is determined via the *endo* or the *exo* transition state and products thereof, also known as Alder's *endo* rule. The rule formulated by Alder and Stein²⁴ points out based on empirical data that an *endo* transition state is preferred over an *exo* transition state although it is often the more sterically crowded one (Scheme 6).

Scheme 6. The *endo*-product is preferred according to the Alder rule.

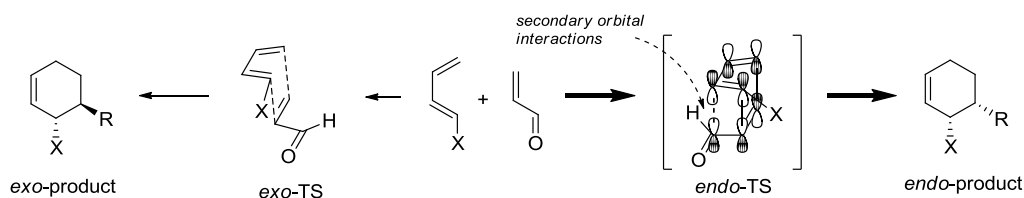

The origin of the *endo*-rule is still under discussion. An old and still prominent rationalization is the secondary orbital interaction (SOI) of the not directly in the bond forming process involved parts of the π -system. This effect, first coined by Woodward and Hoffmann¹³ can

only act if this part can overlap as it is the case in the *endo*-TS (Scheme 6). Although SOIs have been confirmed by Houk and Schleyer et al.²⁵ as the cause of *endo*-selectivity, they remain controversial.²⁶ The *endo* selectivity as well as the DA reaction itself is very sensitive to sterical interactions, being able to reverse *endo/exo*-selectivity as well as slowing down the reaction.²⁷

The synchronicity of the formation of the two bonds determines the stereochemical outcome, conserving *E/Z*-stereoinformations in the product, which is known as the *cis* principle also first illustrated by Alder and Stein (Scheme 7).

Scheme 7. *Cis*-principle, the preservation of *E/Z*-stereoinformation in the product.

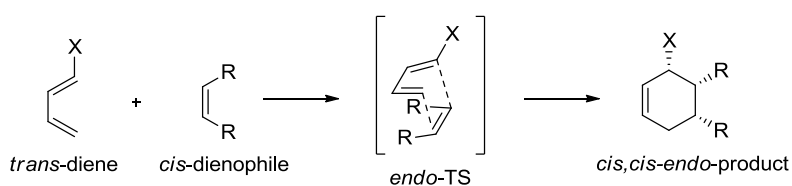

1.2 Hetero Diels-Alder reaction

The hetero (normal) DA reaction is also a very broad applied method to obtain six membered heterocyclic systems.^{2,28-30} By incorporation of an electronegative heteroatom mostly oxygen or nitrogen in the dienophile, its LUMO decreases to obtain a better interaction between the HOMO of the diene. The most common hetero dienophiles are oxa, aza and nitroso compounds (Figure 3).

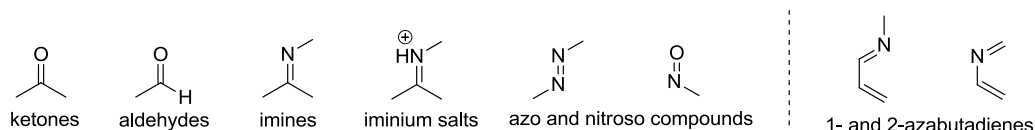
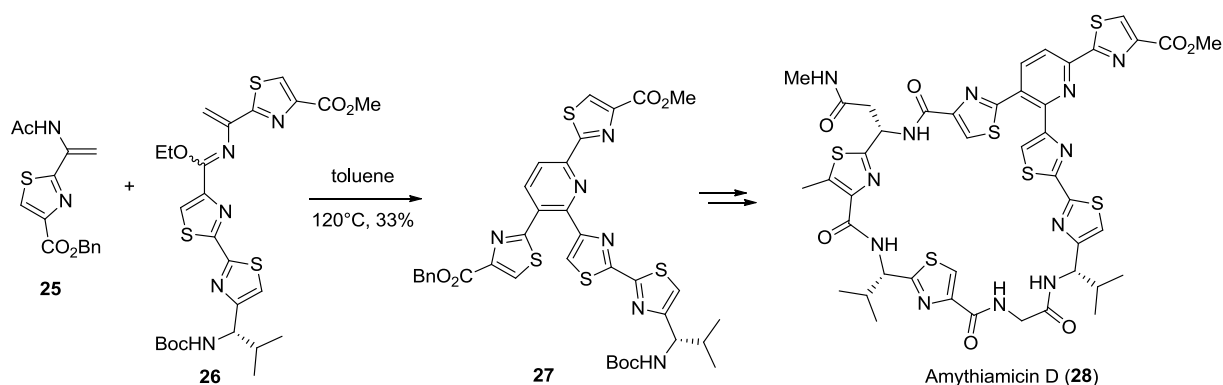

Figure 3. Most common heterodienes and dienophiles in the hetero (normal) DA reaction.

The aza dienes in turn react mainly by HOMO control in a normal DA reactions and the oxa dienes by LUMO control in an IEDDA reaction as discussed later in Chap. 0.

The oxa DA is utilized to form a dihydropyran by reaction of aldehyde or ketone with an electron rich diene.³⁰⁻³³ The reaction was first discovered by Gresham and Steadman in 1949 by reacting 1,3-butadiene **14** and formaldehyde **15** to give dihydropyran **16** (Scheme 8).

Scheme 11. The DA reaction of 2-azabutadiene as key step in the synthesis of amythiamicin D.



The 1-azabutadienes are less often encountered since they are less reactive than 2-azabutadienes³⁸ but in a recent total synthesis of (–)-methyl palustramate (**33**) a 1-azabutadiene **29** was applied (Scheme 12).

Scheme 12. Usage of a 1-azabutadiene in the total synthesis of (–)-methyl palustramate.

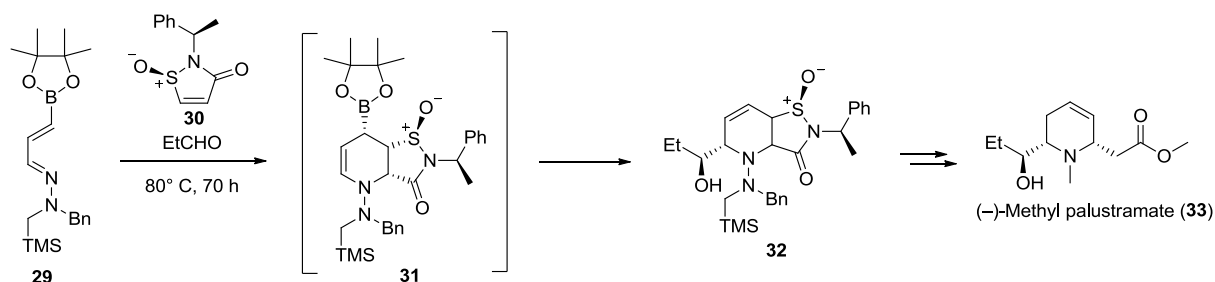

Nitroso-dienophiles are often used to either form pyrrolidines or piperidines as it is nicely presented in the total synthesis of the marine alkaloids fascicularin (**36**) and lepadiformine (**37**) (Scheme 13).³⁹

Scheme 13. Total synthesis of fascicularin and lepadiformine via intramolecular DA reaction of a nitroso-dienophile.

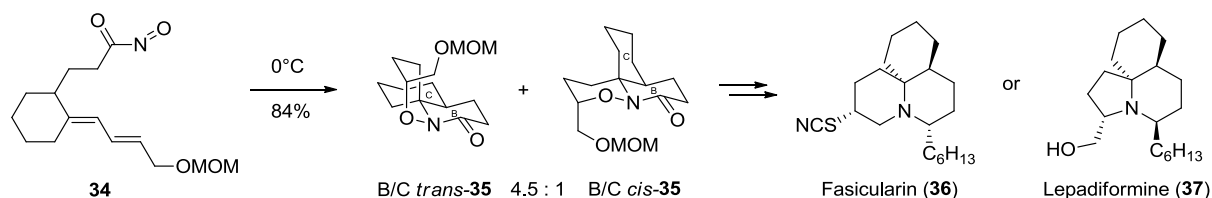

1.3 Retro Diels-Alder reaction

The DA reaction is a reversible process. Since the entropy of the product compared to the starting materials decreases, the entropy term is negative, so that in principle a DA reaction can be thermally reversible (Scheme 14). The so called retro DA or [4+2]-cycloreversion allows the stereospecific formation or restoration of unsaturated bonds. The retro DA reaction is most useful where thermally very stable compounds occur such as aromatics, nitrogen, carbon dioxide or where one product can be degassed or scavenged during the reaction.

Scheme 14. Reversibility leading to the Retro DA at elevated temperatures.

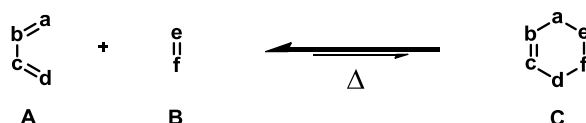

This strategy has intensively been used in total synthesis for the protection of one or two double bonds. Because most of the retro DA reactions make use of extensive heating the procedures are not always convenient and often involve elaborate equipment such as flash vacuum pyrolysis (FVP). In turn, some of the methods are very elegant and will be mentioned in the following. Such a practical example is the reversible protection of dienes by 4-phenyl-1,2,4-triazoline-3,5-dione (PTAD) that can be cleaved under basic treatment at mediocre temperatures (Scheme 15).^{40,41}

Scheme 15. Protection of sterol **38** by PTAD and release by cycloreversion in the synthesis of a vitamin D₃ derivative **40**.

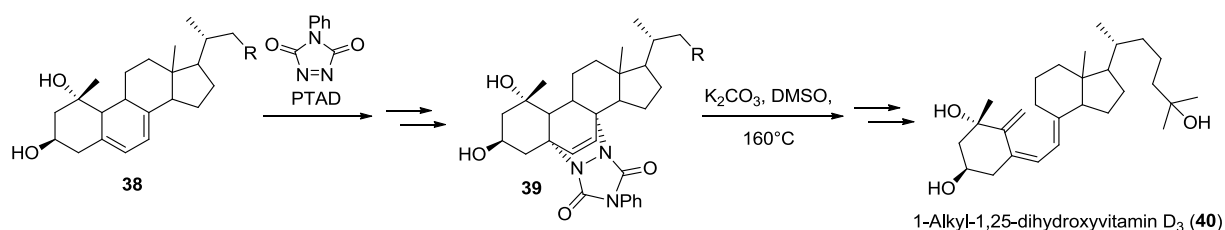

A common way to protect double bonds is via norbornene as in **41** which under thermolysis fragments into cyclopentadiene and the desired dienophile as displayed in the final step of the total synthesis of (±)-diepoxin σ (**42**) (Scheme 16).⁴²

Scheme 16. Restoration of a double bond by a retro DA reaction.

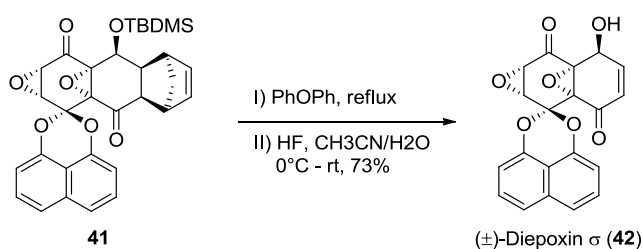

Recently, tetramethylnorbornadiene has been used as an acetylene equivalent in the synthesis of substituted malonic cyclopentenones **44**, where the diene is consumed by the more reactive acid anhydride (Scheme 17).

Scheme 17. Retro DA reaction of tetramethylnorbornene giving rise to cyclopentanones.

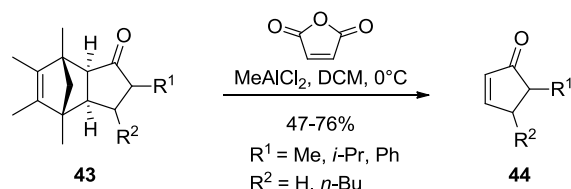

Another application of the [4+2]-cycloreversion is the addition of one dienophile **B** and the release of another **E** by cycloreversion, creating new functionalities (Scheme 18).⁴³⁻⁴⁶

Scheme 18. DA/retro DA reaction transforming compound **A** into **D**.

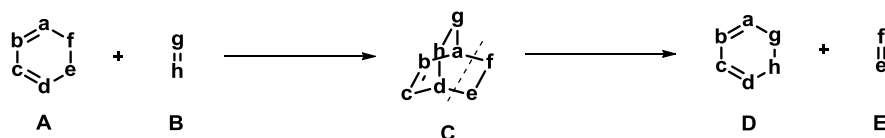

A common method in this sense is the synthesis of furans via DA of an alkyne and an oxazole and subsequent retro Diels-Alder of the oxa-azabicyclic intermediate under evolution of hydrogen cyanide. This strategy has very recently been used in the synthesis of furanosteroid (**47**) via intramolecular DA/retro DA reaction of oxazole **45** (Scheme 19).⁴⁷

Scheme 19. Studies of the use of DA/retro DA reaction for the formation of furans in the synthesis of furanosteroids.

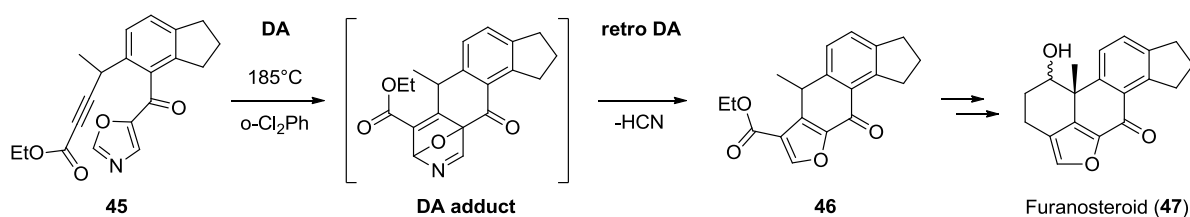

1.4 Inverse electron demand Diels-Alder reaction

In the inverse electron demand Diels-Alder (IEDDA) reaction, electron rich dienophiles react with electron deficient dienes, i.e. the interaction of the HOMO of the dienophile with the LUMO of the diene gives the major contribution to the reaction energy (Figure 1). For this reason the diene is either consisting of very electronegative heteroatoms or substituted by EWGs.

The existence of the IEDDA reaction was first demonstrated through a kinetic study in the early 60's by Sauer and Wiest.⁴⁸ One of the first IEDDA reactions was the synthesis of pyridazines **51** from 1,2,4,5-tetrazines **48** (Scheme 20) in the late 50's⁴⁹ by Carboni and Lindsey. Since its discovery, the IEDDA reaction of tetrazines has gradually gained in interest over the past fifty years and nowadays offers a broad application spectrum.^{50,51}

Scheme 20. First IEDDA reaction by Carboni and Lindsey to synthesize substituted pyridazines.

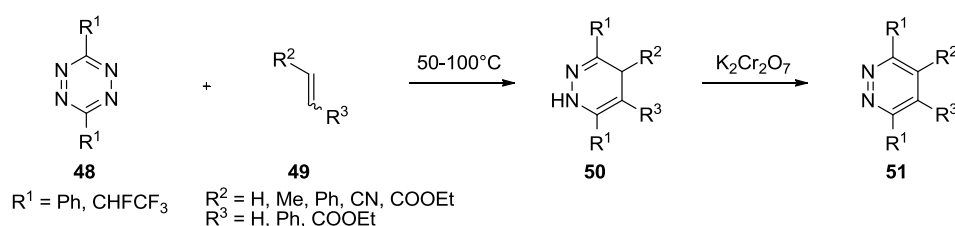

Often, the IEDDA reaction involves hetero dienes, so that one can meet certain ambiguity concerning the equal semantic usage of “hetero” and “inverse electron demand” that is especially not possible since hetero DA reactions of heterodienophiles are generally normal DA reactions as we have seen in Chap. 1.2.

Frequently, also non-hetero dienes can be found in the IEDDA reaction. A very common diene in this perspective is the α -pyranone **52**, which for example has been used in the total synthesis of (\pm)-occidentalol **56** within a DA/cycloreversion cascade (Scheme 21).⁵²

Scheme 21. IEDDA reaction involving pyranone in the total synthesis of (\pm)-occidentalol.

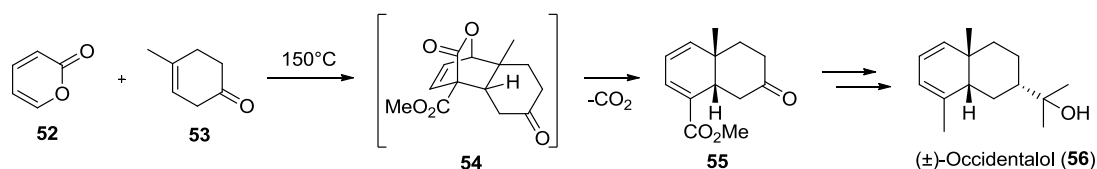

Or recently the total synthesis of (\pm)-galanthamine (**61**) was presented, where an intramolecular cycloaddition of pyranone **59** at lower temperatures did not further proceed to eliminate carbon dioxide (Scheme 22).⁵³

Scheme 22. Pyranone in an intramolecular IEDDA reaction employed in the total synthesis of (±)-galanthamine.

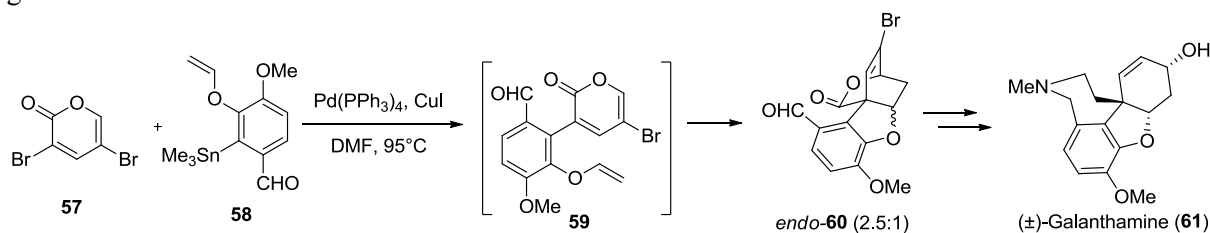

Also *o*-Quinones have been engaged in cycloaddition as an electron deficient dienophile. This is shown by a late example where the reactivity of *o*-fluoranil (62), a perfluorinated *o*-quinone was studied (Scheme 23).

Scheme 23. *O*-fluoranil as a very electron deficient homo dienophile in the IEDDA reaction.

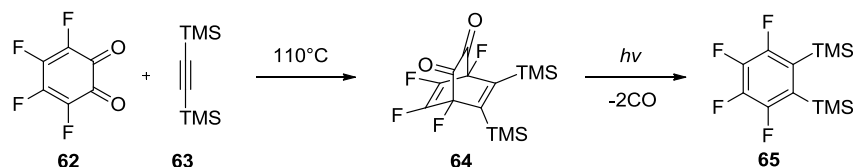

As discussed above much often encountered in the IEDDA reaction is the use of a hetero dienophile where one or more atoms are exchanged by more electronegative atoms (Figure 3). In this perspective the 1-azadiens are rather part of the normal DA reactions. But none the less, they can be activated with an EWG as in *N*-sulfonyl-1-azadienes developed by Boger et al. and applied to the total synthesis of nothapodytine B (69),⁵⁴ by reacting sulfonyl-1-azadiene 66 with the electron rich ketene acetal 67 and other natural products (Scheme 24).⁵⁵

Scheme 24. Activated *N*-sulfonyl-1-azadiene in the total synthesis of nothapodytine B.

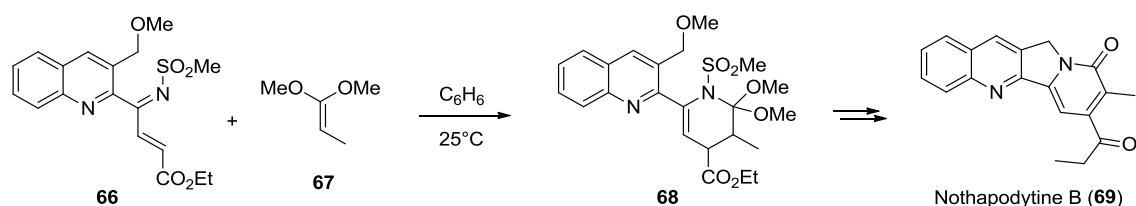

1.4.1 Inverse electron demand Diels-Alder reaction of aza-heteroaromatics

The “azine” DA reactions involve the reaction of nitrogen heteroaromatics as electron deficient dienes. The DA reaction of such compounds is also sometimes called hetero DA reaction and is further strictly termed an inverse electron demand hetero DA reaction.

The IEDDA reaction of heteroaromatics **A** generally follows a DA/retro DA reaction scheme as described in Chap. 0, where often molecular nitrogen is formed. The diene intermediate **D**

can rearomatize by oxidation or by elimination of a leaving group, which can be introduced with both the diene and the dienophile **B** as we will see later (Scheme 25).

Scheme 25. DA/retro DA reaction of heteroaromatics.

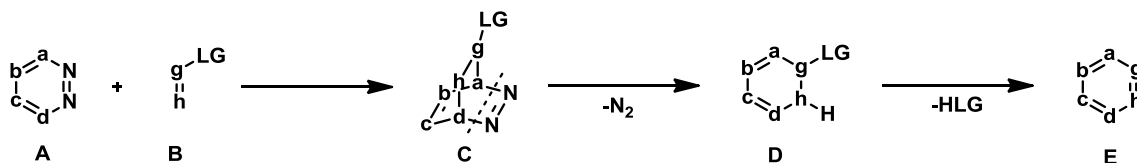

1.4.2 Inverse electron demand Diels-Alder reaction of tetrazines

The 1,2,4,5-tetrazine⁵⁶ is the only really described diene in the IEDDA reaction, where the DA chemistry of 1,2,3,4-tetrazines⁵⁷ and 1,2,3,5-tetrazines is rather unknown (Figure 4).

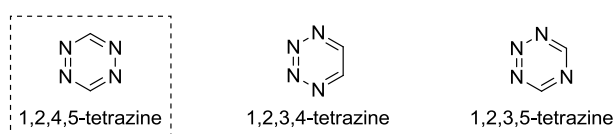

Figure 4. All possible tetrazines.

Tetrazines are often substituted with EWG to further lower the LUMO energies to facilitate the reaction with an electron rich dienophile. In turn, the dienophiles possess ERGs to obtain an electron rich double bond concomitantly increasing the HOMO energy. Sauer et al. have intensively studied the kinetics of the IEDDA reaction of 1,2,4,5-tetrazine with a variety of different dienophiles, giving an excellent assumption about the general reactivity of dienophiles (Figure 5).⁵⁸

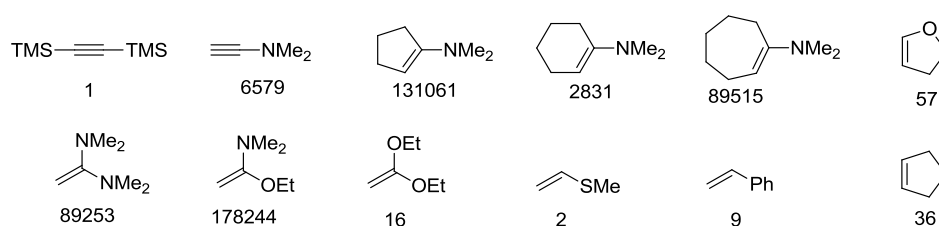

Figure 5. A selection of the most important dienophiles in the reaction with 1,2,4,5-tetrazine with the relative kinetic rate constants in $\text{M}^{-1}\text{s}^{-1}$ at 20°C in 1,4-dioxane.

Thereby, nitrogen is a much better ERG than oxygen. The linear dienophiles are more reactive than their cyclic analogues and the reactivity of the linear dienophiles is very much depending on the bulk of the second ERG, more than on its electronic effect.⁵⁹

The IEDDA reaction of tetrazines, as Carboni and Lindsey realized in their pioneering work, has been used to synthesize diazines (Scheme 20) and has been very much put forward by the

work of Boger and co-workers. A neat way they made use of the pyridazine synthesis, is the divergent method to react tetrazine **70** to indoline **73** or pyrrole **72** via 1,2-diazine **71**, which has been intensively used in the natural product synthesis (Scheme 26).⁶⁰

Scheme 26. Divergent method via IEDDA reaction to access highly substituted indoles and pyrroles.

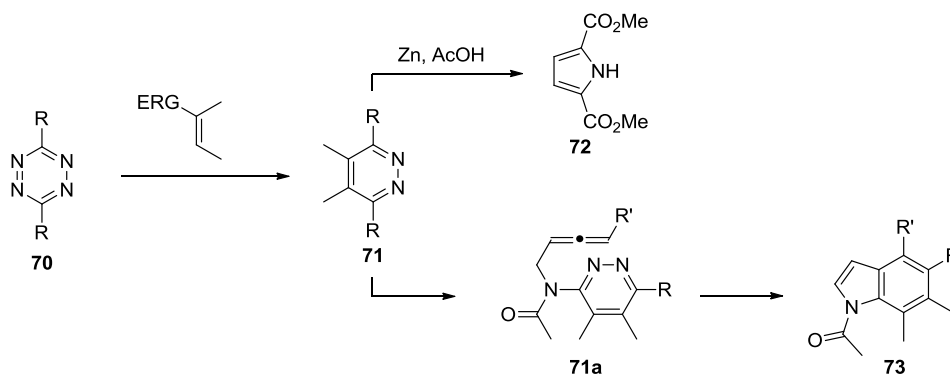

Compared to conventional synthetic methods, this method gives direct access to highly substituted heteroaromatics, such as lately displayed in the total synthesis of lycogarubin C (**77**) (Scheme 27).

Scheme 27. Total synthesis of lycogarubin C utilizing the tetrazine → diazine → pyrrole DA strategy.

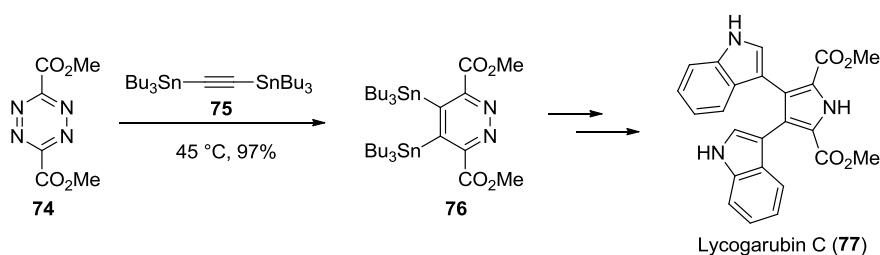

The IEDDA reaction strategy to access indoles from tetrazine via diazine was put into context in the total synthesis of trikentrin A (**83**) (Scheme 28).⁶¹

Scheme 28. The divergent tetrazine → diazine → indoline DA strategy applied in the total synthesis of *cis*-trikentrin A.

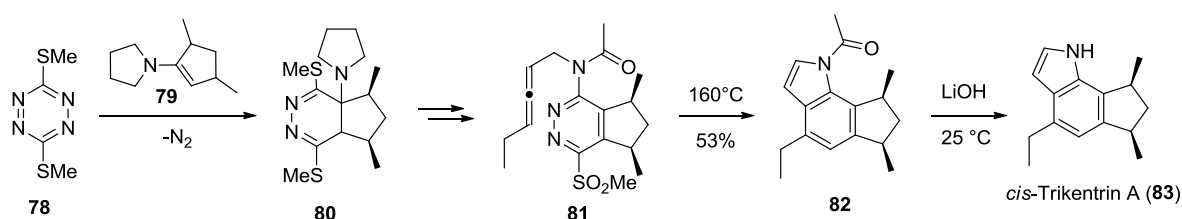

Lately the IEDDA reaction of 1,2,4,5-tetrazine **85** was extensively used as a ligation reaction with the very strained *trans*-cyclooctenes **84** (Scheme 29).^{62–65}

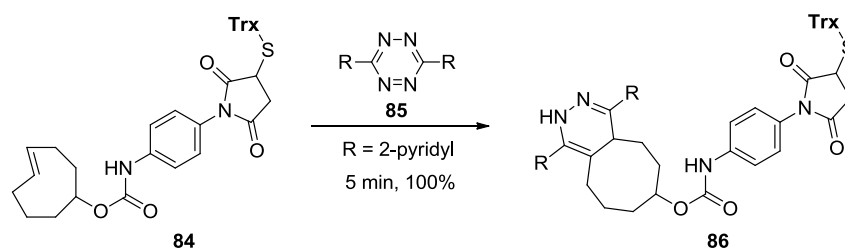
Scheme 29. IEDDA reaction of strained *trans*-cyclooctenes for the ligation of thioredoxin (Trx).

1.4.3 Inverse electron demand Diels-Alder reaction of triazines

In case of the triazines all possible isomers in Figure 6 are well described dienes in the IEDDA reactions to form pyridines and pyrimidines after a DA/retro DA-rearomatization procedure with elimination of nitrogen or cyanides and a leaving group (Scheme 25).

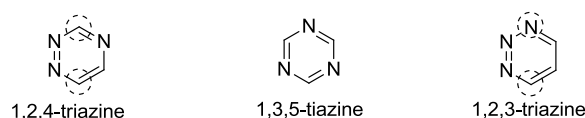
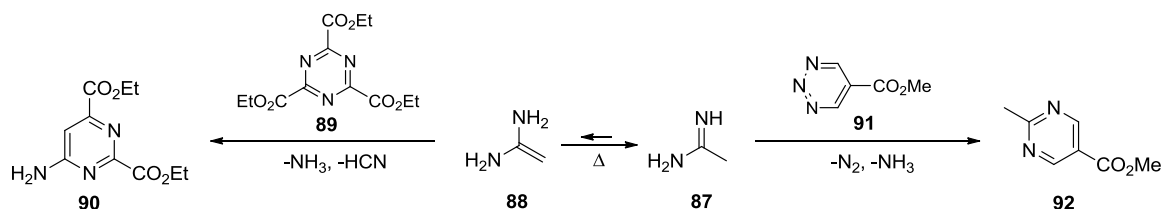

Figure 6. Triazines used in the IEDDA reaction.

The first two members of the triazines have been well investigated around thirty years ago but the 1,2,3-triazine although known since the 80's⁶⁶ has only very recently been disclosed by Boger and co-workers.^{67,68} The triazines react on the positions marked by dotted circles (Figure 6). The performance of the triazines in comparable reactions is as following, 1,2,4-triazine \approx 1,3,5-triazine $>$ 1,2,3-triazine, although calculations predict different.⁶⁸ It seems that 1,2,3-triazines react rather in a HOMO controlled reaction i.e. a normal DA reaction as the different reactivity of amidine **87** toward the 1,3,5-triazine **89** and 1,2,3-triazine **91** shows (Scheme 30).^{68,69}

Scheme 30. Different reactivity of 1,2,3-triazine and 1,3,5-triazine in the reaction with amidine.



Besides the detailed studies of the scope of the IEDDA reaction of triazines, 1,2,4-triazines have been applied in total synthesis.⁷⁰ The IEDDA reaction of 1,2,4-triazine is still used to generate highly substituted pyridines as displayed in the key step of the total synthesis of louisianin A (**96**) (Scheme 31).⁷¹

Scheme 31. Application of 1,2,5-triazine in the synthesis of louisianin A.

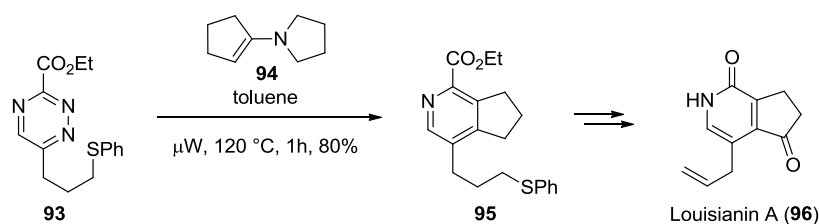

1.4.4 Inverse electron demand Diels-Alder reaction of diazines

The 1,2-diazine dienes are much less reactive than tetrazines and even less reactive than triazines in the IEDDA reaction. None the less, the IEDDA reaction of 1,2-diazene was initially described over three decades ago.^[5,6] However, due to the relatively high energy of the LUMO of diazines, the reaction requires harsh conditions that limit the utility of this valuable transformation. Therefore, these reactions are only scarcely disclosed and commonly only involve IEDDA reactions of activated diazines with very electron rich dienophiles such as propynamines or ethenamines (Figure 5).^{50,51} These reactions are described for all of the diazines in Figure 7.

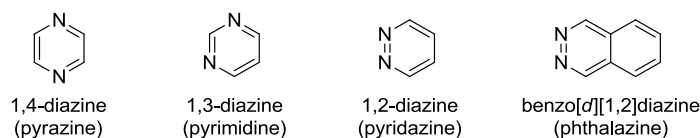
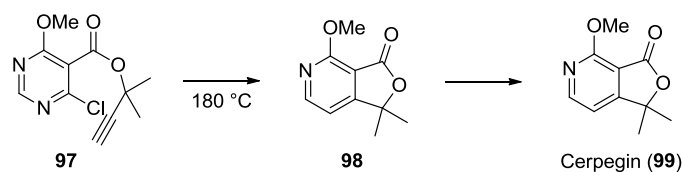

Figure 7. Diazines used in the IEDDA reaction.

Pyrazine and pyrimidine react under extrusion of a cyanide to form pyridines after elimination of a leaving group. Because of the poor reactivity and since they lead to the same product as the more reactive triazines, the application of these diazines is very limited, although the methodology of pyrimidine especially in the intramolecular IEDDA was thoroughly explored in the 80's by van der Plas.⁷²⁻⁸¹ The method has been utilized to synthesize cerpegin (99) (Scheme 32).⁸²

Scheme 32. Intramolecular IEDDA reaction of pyrimidine for the synthesis of cerpegin.



The first IEDDA reaction of electron deficient pyridazine was described by Neunhoeffer et al. almost forty years ago.⁸³ The reaction follows the usual course (Scheme 25), where the pyridazine 100 first undergoes an IEDDA reaction with methoxy ethenamine 101 to obtain

cycloadduct **102**, which after extrusion of molecular nitrogen and rearomatization by elimination yields aniline **104** (Scheme 33).

Scheme 33. First IEDDA reaction of electron deficient pyridazine.

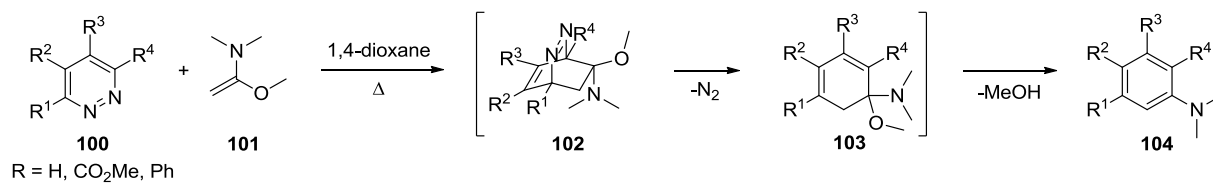

This was followed later by the intramolecular approach by Jojima et al. where an alkene tethered to pyridazine **105** was reacted at 210°C in diethylaniline (DEA) to obtain hydroxyxanthene **107** (Scheme 34).⁸⁴

Scheme 34. First intramolecular IEDDA reaction of pyridazine.

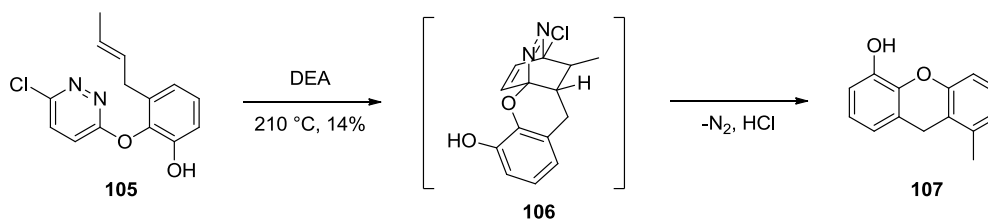

For preliminary studies towards a total synthesis Boger and co-worker developed a general indoline synthesis via pyridazine linked alkyne **108** (Scheme 35). Later they used the strategy in conjunction with an IEDDA reaction of 1,2,4,5-tetrazine **78** in the total synthesis of triketrin A (**83**) (Scheme 28).

Scheme 35. Indoline synthesis by an IEDDA reaction of alkyne linked to pyridazine.

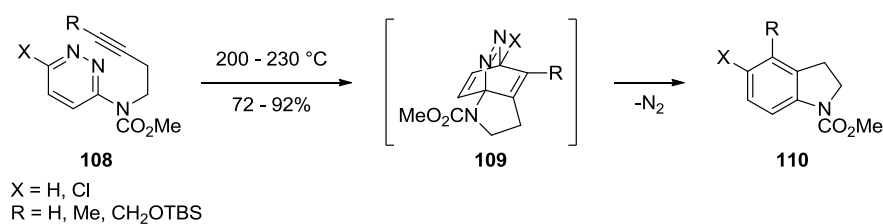

With the synthesis of the highly electron rich dienophile 2-alkylidene-imidazolidines **112**, Heuschmann and Gruseck were able to react unsubstituted pyridazine and phthalazine **111** although still at rather high temperatures (Scheme 36).⁸⁵

Scheme 36. Highly electron rich dienophile in the IEDDA reaction with unsubstituted 1,2-diazines.

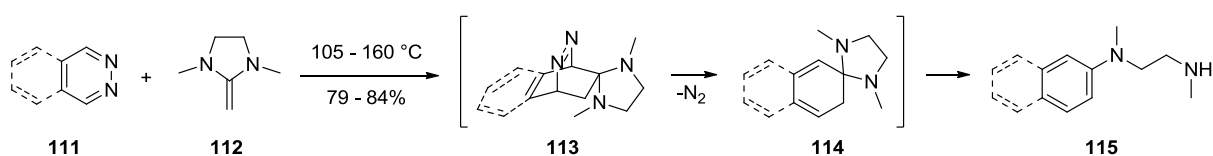

Further studies concerned different EWG substituted i.e. activated pyridazines such as 4,5-dicyanopyridazine^{86–89} and intramolecular IEDDA reactions of pyridazine.^{90–93} Hence, the intramolecular IEDDA reaction found other applications in the total synthesis of amaryllidaceae alkaloids⁹⁴ and in the formal synthesis of (±)-strychnine (**118**) (Scheme 37).⁹⁵

Scheme 37. Formal total synthesis of (±)-strychnine via indole linked to pyridazine.

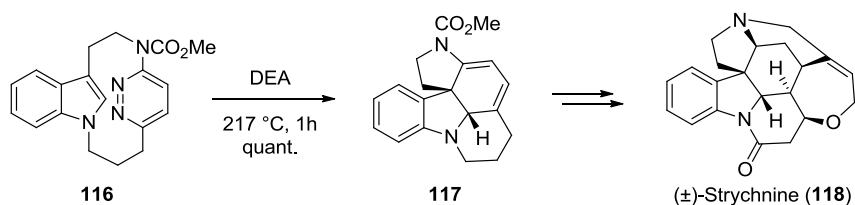

There is little known about the reactivity of phthalazines in the IEDDA reaction with electron rich dienophiles. Oishi and co-worker have reported the reaction of ynamines and enamines in the reaction of 1-substituted phthalazines. The reaction of enamine **120** with phthalazines **119** proceeded only at high temperatures of 120 – 160 °C with the enamine as solvent to give the corresponding naphthalene **121** in yields of 33 – 86% depending on the level of electron withdrawal of the substituent (Scheme 38).⁹⁶

Scheme 38. IEDDA reaction of enamine with 1-substituted phthalazines.

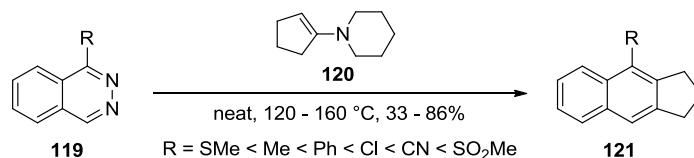

The sterically less hindered diethylethyamine is more reactive undergoing a cycloaddition with 1-substituted phthalazines **119** at 25 – 80 °C (Scheme 39). Since, compared to the enamines, some of the products did not match a concerted reaction path, a zwitterionic intermediate was suggested, which then leads to different products. The 1-chlorophthalazine **119c** underwent a second addition of diethylethyamine and a ring closure reaction to give a 6-membered heterocycle **126**, which by elimination of hydrogen chloride gives the phenylpyridine product **127** in 68% yield.⁹⁷ The substituents which stabilize the negative charge in the 1-position led to the substituted naphthalene product **124** and in the case of the benzoyl residue the diazocin by-product **129** was observed in a 1:1 ratio (Scheme 39).⁹⁸

Scheme 39. Reaction of phthalazines with diethylethyne reacting by a zwitterionic intermediate.

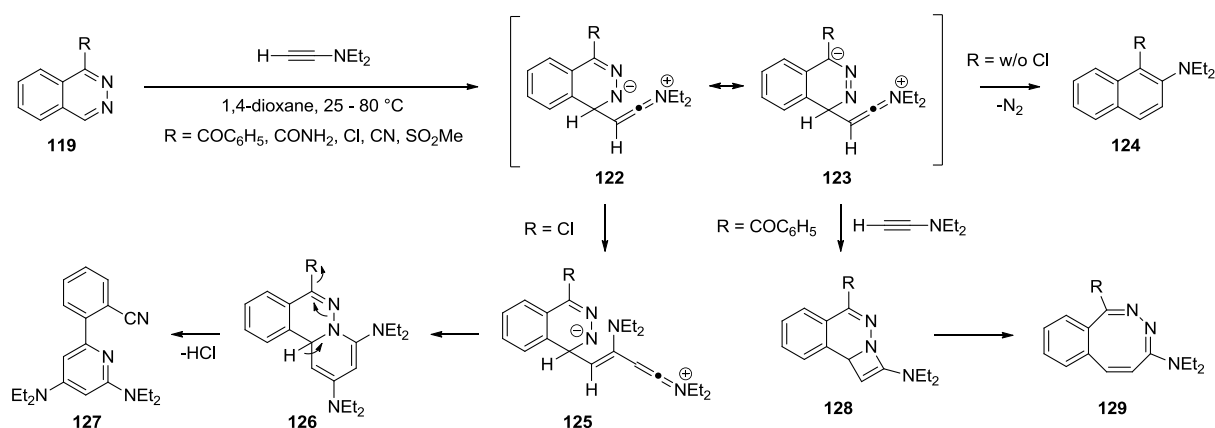

Very recently, a silver catalyzed formal IEDDA reaction of substituted and unsubstituted phthalazine **130** with triisopropylsilyloxyethyne **131** was reported by Rawal et al. to give substituted naphthalenes **135** with good yields at room temperature (Scheme 40).⁹⁹ The mechanism of the reaction is very similar to the one discussed by Oishi (*vide supra*). The catalytic cycle starts with the complexation of the acetylene **131** and diazine **130** by silver which then undergoes a nucleophilic attack resulting in diazaenolate intermediate **133**. Further intramolecular addition and elimination of molecular nitrogen produces the substituted naphthalene product **135** in good yields of 67 - 95% (Scheme 40). It is however interesting to mention that in the silver catalyzed formal IEDDA reaction, 1-chlorophthalazine instead of yielding phenylpyridine similar to **127** resulted in the desired 1-chloronaphthalene **135a**.

Scheme 40. Silver (I) catalyzed reaction of phthalazine with oxetyne to produce substituted naphthalene.

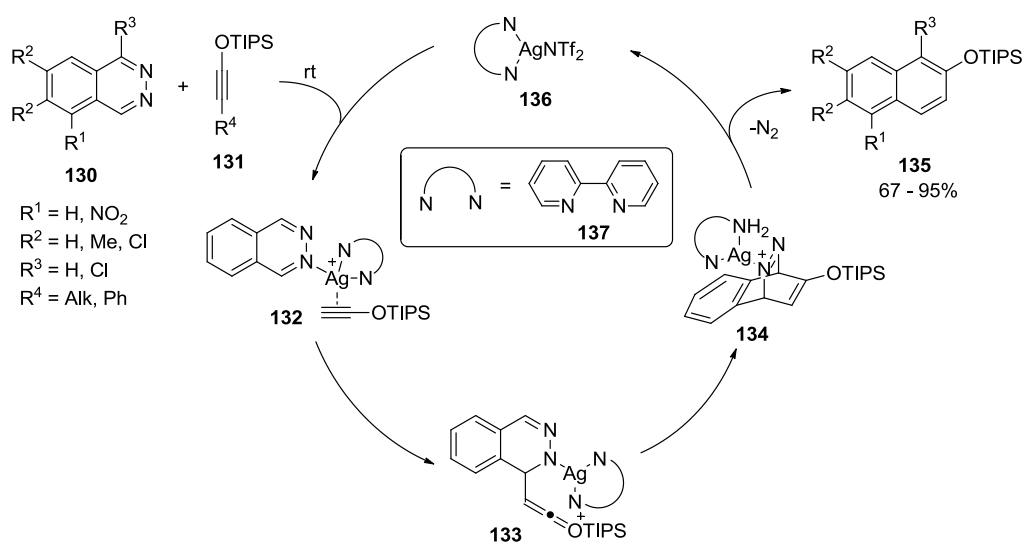

1.5 Lewis acid catalysis

A Lewis acid is a molecular entity that acts as an electron-pair acceptor, able to react with an Lewis-base to form an Lewis-adduct.¹⁰⁰ This is a definition for acids and bases, formulated by G. N. Lewis in 1923. It is a more general view of acidity compared to the Brønsted model, which defines acid and base as proton donor and acceptor. In catalysis the Lewis acid presents one of the most widely used kind of catalysts. Lewis acids used in organic chemistry are alkali and alkaline earth metals such as Li, Na, Mg, and Ca, transition metals e.g. Sc, Ti, Zr, Hf, V, Mo, Cu, Ag, Au, Zn, and Hg, lanthanides for example La and Yb or post transition metals and metalloids such as B, Al and Si which can be employed in a hetero or homogenous fashion.¹⁰¹ According to the above definition the Lewis acid acts as a promoter or catalyst by accepting an electron pair of a Lewis base i.e. an electrophile which by donation of electron density to the Lewis acid becomes electron deficient and, therefore, more reactive towards an electron rich reagent such as a nucleophile. In the FMO picture the Lewis acid catalyst acts by lowering the LUMO energy of the electrophile, the dienophile in the normal DA or the diene in the IEDDA reaction (Figure 8).

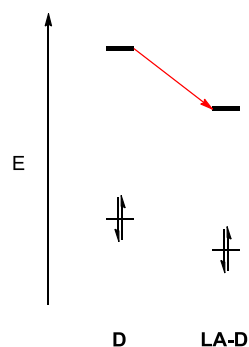
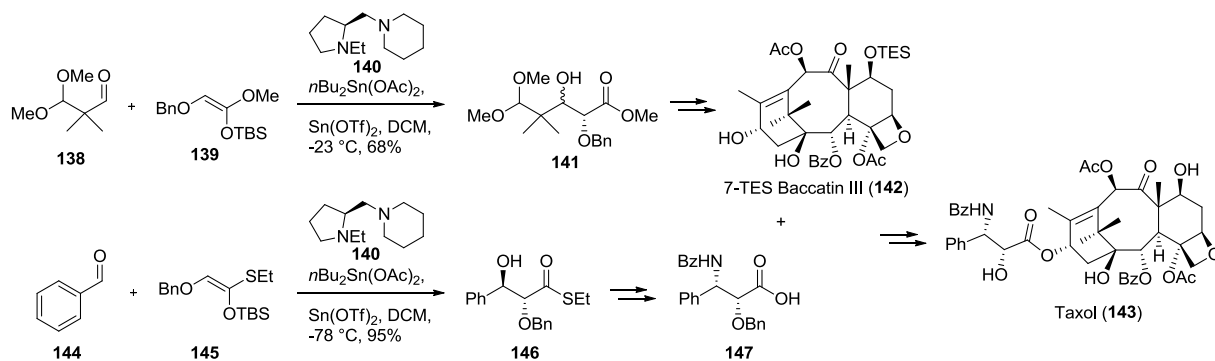

Figure 8. Decrease of the energy of the LUMO of the Lewis base i.e. donor (**D**) by the interaction with a Lewis acid (**LA**).³⁰

The application of Lewis acids as catalysts or promoters encompasses a wide range of different reactions. Most prominently is the use of the Lewis acids AlCl_3 or FeCl_3 in the Friedel Crafts reaction. Lewis acids are used for the polymerization of alkenes. Ether cleavage of linear or cyclic ethers such as epoxides or oxethanes is also promoted by Lewis acids. A well known aldol reaction is the Mukaiyama reaction. This reaction is catalyzed by TiCl_4 or by a chiral catalyst as shown in the total synthesis of taxol **143** where Mukaiyama used his method even two times (Scheme 41).¹⁰²

Scheme 41. Total synthesis of Taxol by Mukaiyama with his catalyzed aldol reaction.



A hot topic in the field of Lewis acid chemistry is the application of frustrated Lewis pairs, which is a pair of Lewis acid and base sterically too hindered to form a ‘classical’ Lewis acid-base adducts. This was first noticed by Brown et al.¹⁰³ in the mixture of BMe_3 **149** and lutidine **148** which did not react to form a complex **150** (Scheme 42).¹⁰⁴

Scheme 42. First notification of a frustrated Lewis pair.

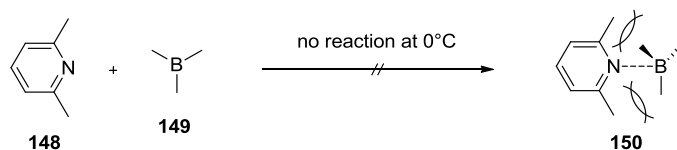

Recently, Stephan and co-worker presented a hydrogenation of olefins catalyzed by the frustrated Lewis pair combination of tris(perfluorophenyl)boron and (perfluorophenyl)-diphenylphosphine at room temperature.¹⁰⁵

1.5.1 Lewis acids in the Diels-Alder reaction

Also in the DA reaction Lewis acids have found intensive application for the activation of the dienophile in the normal DA reaction and the activation of diene, or heterodienes in the IEDDA reaction as depicted in Figure 9.

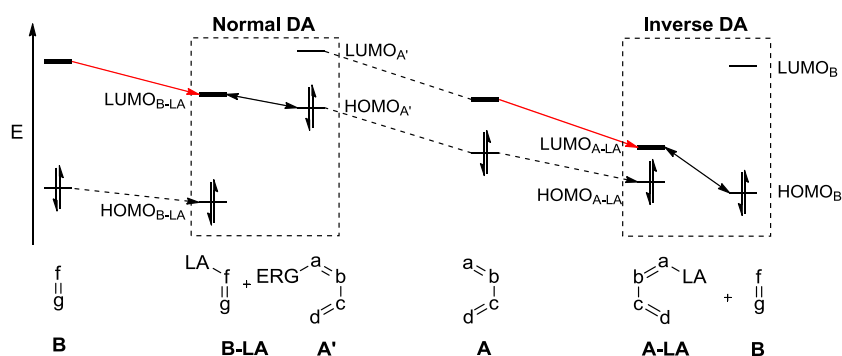
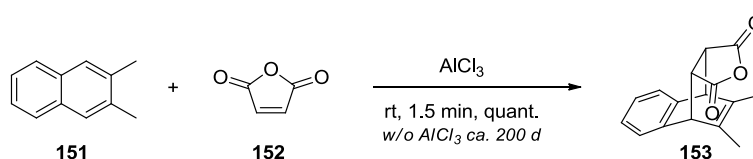

Figure 9. Effect of Lewis acid on the dienophile or diene in the normal DA and the IEDDA reaction.

In the normal DA reaction the Lewis acid (**LA**) decreases the LUMO energy of the dienophile **B** and in the IEDDA reaction the LUMO of the diene **A** to assure a better interaction with either the HOMO of the electron rich diene **A'** or the HOMO of a dienophile **B**.

In the beginning of the 60's Yates and Eaton recognized that AlCl_3 is able to greatly enhance the activity of the dienophilic maleic anhydride **152** in the reaction of anthracene or dimethylnaphthalene **151** to give the DA adduct **153** (Scheme 43).¹⁰⁶

Scheme 43. Pioneering Lewis acid promoted DA reaction.



Ten years later, Corey et al. were the first to utilize the concept of Lewis acid catalyzed DA in total synthesis for the preparation of the key intermediate **156** in the synthesis of prostaglandin **157** (Scheme 44).¹⁰⁷

Scheme 44. Copper(II) catalyzed DA key step in the total synthesis of prostaglandin.

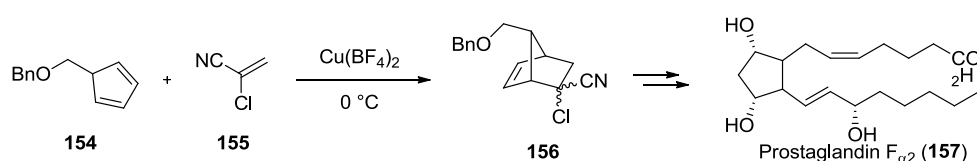

Consequently, they developed a highly enantioselective version of their Lewis acid catalyzed DA by the use of a (*S*)-pulegone derived acrylate **158** as an asymmetric inductor (Scheme 45).¹⁰⁸

Scheme 45. Enantioselective formal synthesis of Prostaglandin $\text{F}_{\alpha 2}$ via Lewis acid catalyzed DA reaction.

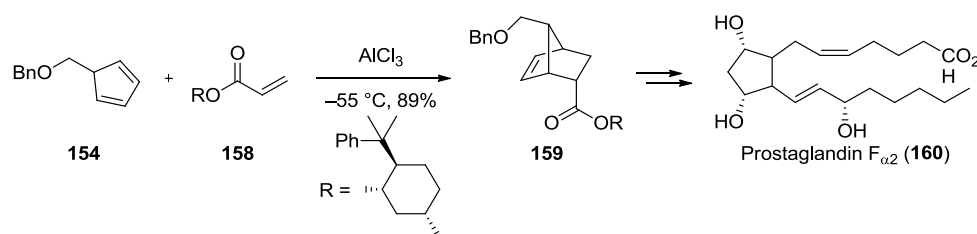

Following up on the preliminary results of Corey, Koga and co-workers apparently asked themselves if the chiral auxiliary can be part of the catalyst. So they conducted the first described enantioselective DA reaction catalyzed by a chiral Lewis acid, an aluminum

compound as well based on (*S*)-pulegone.¹⁰⁹ This results constituted the initiation of the very attractive field, the enantioselective Lewis acid catalyzed DA reaction.^{9-11,110-112}

1.5.2 Bifunctional Lewis acids in catalysis

Nature's highly complex catalytic proteins the enzymes are the true master of using multi point binding. A famous example is the catalytic triad of serine proteases such as trypsin. Or the very illustrative example of the chorismate mutase which catalyzes a [3,3]-sigmatropic rearrangement of chorismate to prephenate involving multidentate hydrogen binding events (Figure 10).¹¹³⁻¹¹⁵

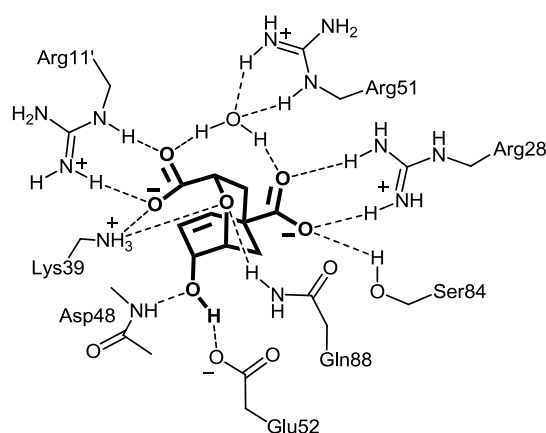

Figure 10. Complexation of a transition state analog in the active site of *E. coli* chorismate mutase.

To use hydrogen bonding by Brønsted acids to activate substrates in a bidentate fashion is a still emerging field in catalysis. There are different examples, where double hydrogen bonding is the key principle of activation. As in the case of thiourea catalysis¹¹⁶⁻¹²¹ where Takemoto and co-workers developed a Michael addition of nitroolefins (**161**)¹²² as well as α,β -unsaturated imines to malonates (**162**).¹²³ Another example is the Brønsted acid-catalyzed IEDDA reaction of azabutadiene (**163**) and electron-rich alkenes.¹²⁴ In all these complexes a bidentate coordination of the two acid protons to two different sites, oxygen or nitrogen is proposed (Figure 11).

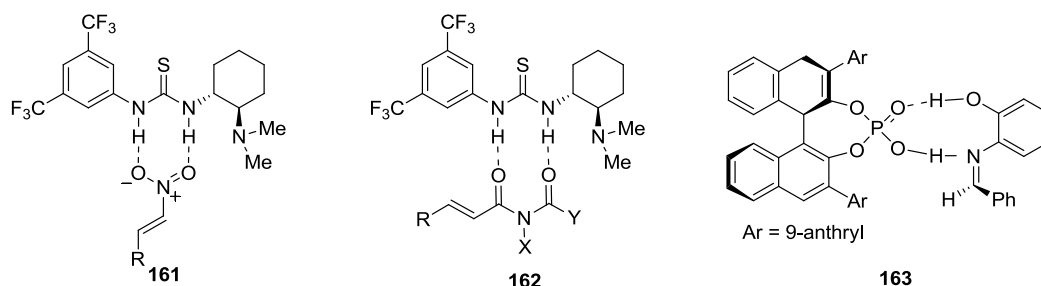
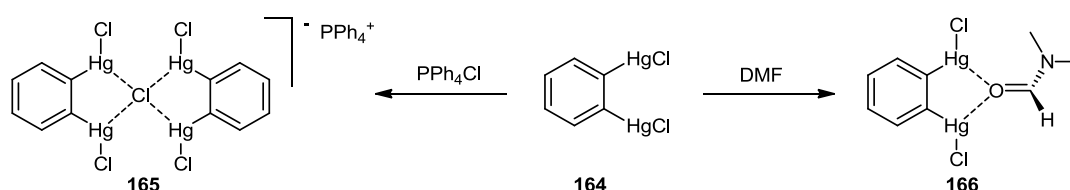

Figure 11. Brønsted acid catalysts acting as bidentate activators.

As observed in the pioneering work of Yates and Eaton the Lewis acid has a tremendous effect on the reaction rate that is attributed to the decrease of the LUMO energy upon coordination to the dienophile, which improves the overlap and facilitates the reaction, leading to higher regioselectivity as well as milder reaction conditions (Scheme 43 and Figure 9).¹²⁵ However, in most of the cases of Lewis acid catalysis monodentate Lewis acids are employed.

The first study of the reactivity of a bidentate Lewis acid was conducted 40 years ago by Biallas and Shriver.¹²⁶ They examined the cleavage of bis(triphenylmethyl)ether by bidentate 1,2-bis(difluoroboryl)ethane and the reactivity of the formed complex. For a long time no attention was given to bidentate Lewis acids until twenty years later, Wuest and co-workers began to intensively study the coordination chemistry of multidentate Lewis acids. They commenced with the investigation of dihalogen-1,2-phenylenedimercury compounds in the complexation with chloride anion (**165**)¹²⁷ and dimethylformamide (**166**)¹²⁸ (Scheme 46).

Scheme 46. Bidentate mercury Lewis acid in the complexation of chloride and dimethylformamide



This investigations showed that the association of carbonyl compounds with organomercury compounds are weak, but also that a double coordination involves stronger structural changes (bond lengthening) than single coordination. Although the target was to develop stronger multidentate Lewis acids for the application in chemical reactions they did not succeeded and have not reporting any progress in this field ever since.¹²⁹ Reilly and Oh worked on the stronger bidentate boron Lewis acid, based on a naphthalene framework and showed in the 90's the application of their Lewis acid as chiral catalyst with chiral ligands in the DA reaction. They used chiral ligands such as amino acids **171** and diols with 10 mol% Lewis

acid **169** to catalyze the reaction of acrylaldehyde **167** and cyclopentadiene **168** (Scheme 47).¹³⁰

Scheme 47. Example of bidentate Lewis acid with chiral ligand employed in the DA reaction.

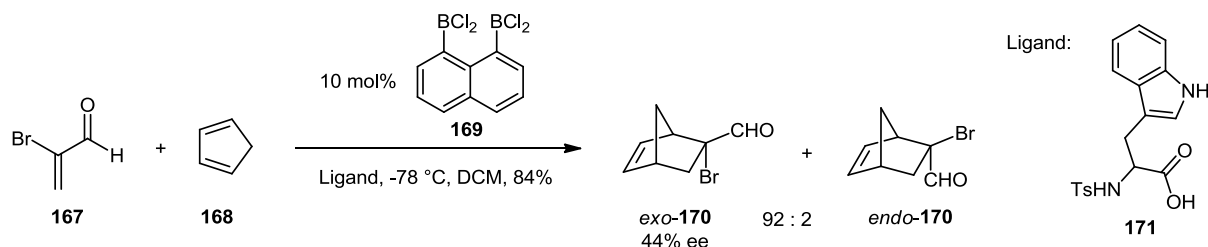

However, they did not compare their results with a monodentate Lewis acid and indicated that the structure and the mode of complexation is unknown. Further results of the complexation of their bidentate Lewis acid with a more Lewis basic substrate suggested an equilibrium of a mono and bidentate coordination mode.¹³¹ Eventual comparison of the bidentate 1,8-bis(dichloroboryl)-naphthalene **169** with phenylboron dichloride in the DA reaction of butenal with cyclopentadiene resulted even in a slightly inferior performance of the bidentate Lewis acid.¹³²

Maybe inspired by Wuests late work, Maruoka showed for the first time the beneficial application of a bidentate aluminum Lewis acid **BD** in a chemical reaction.¹³³ By the comparison of the bidentate Lewis acid **BD** together with a monodentate Lewis acid **MD** in promoting the reduction of ketone **172** with Bu₃SnH, he showed the superiority of the bidentate Lewis acid **BD** in this transformation (Scheme 48).

Scheme 48. First example of a superior bidentate Lewis acid in a chemical reaction.

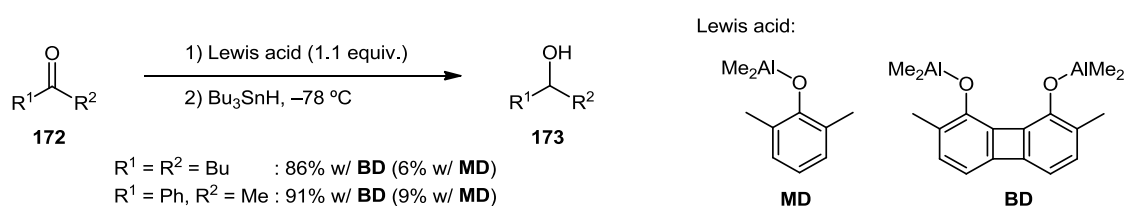

The transformation did hardly work in the presence of a monodentate Lewis acid **MD** which showed the further enhancement in electrophilicity of the ketone **172** by an additional bonding in the bidentate Lewis acid complex. In the same publication they showed the enhanced effect of **BD** on the Mukaiyama aldol reaction of silylenolates with Michael acceptors as well as on the Claisen rearrangement. Later on, the concept was also applied to the Meerwein–Ponndorf–Verley (MPV) reaction (also in an asymmetric fashion), and the Tishchenko reaction.¹³⁴ In view of a wider applicability of the bidentate Lewis acid in catalysis they

started to design titanium based Lewis acids able to catalyze the reduction of ketone with Bu_3SnH by 10-20 mol% of catalyst.^{135,136} With the same catalyst also the catalytic cleavage of epoxides was shown. Also, they showed the application of a chiral titanium based bidentate Lewis catalyst in the asymmetric 1,3-dipolar cycloaddition.¹³⁷

1.6 References

- (1) Diels, O.; Alder, K. *Liebigs Ann. Chem.* **1928**, *460*, 98–122.
- (2) Tietze, L.; Ketschau, G. In *Stereoselective Heterocyclic Synthesis I*; Metz, P., Ed.; Topics in Current Chemistry; Springer Berlin, Heidelberg, 1997; Vol. 189, pp. 1–120.
- (3) Nicolaou, K. C.; Snyder, S. A.; Montagnon, T.; Vassilikogiannakis, G. *Angew. Chem. Int. Ed.* **2002**, *41*, 1668–1698.
- (4) Bandaranayake, W. M.; Banfield, J. E.; Black, D. S. C. *J. Chem. Soc., Chem. Commun.* **1980**, 902–903.
- (5) Nicolaou, K. C.; Petasis, N. A.; Zipkin, R. E.; Uenishi, J. *J. Am. Chem. Soc.* **1982**, *104*, 5555–5557.
- (6) Laschat, S. *Angew. Chem. Int. Ed. Engl.* **1996**, *35*, 289–291.
- (7) Stocking, E. M.; Williams, R. M. *Angew. Chem. Int. Ed.* **2003**, *42*, 3078–3115.
- (8) Kim, H. J.; Ruzsyczky, M. W.; Choi, S.; Liu, Y.; Liu, H. *Nature* **2011**, *473*, 109–112.
- (9) Kagan, H. B.; Riant, O. *Chem. Rev.* **1992**, *92*, 1007–1019.
- (10) Dias, L. C. *J. Braz. Chem. Soc.* **1997**, *8*, 289–332.
- (11) Reymond, S.; Cossy, J. *Chem. Rev.* **2008**, *108*, 5359–5406.
- (12) Merino, P.; Marqués-López, E.; Tejero, T.; Herrera, R. *Synthesis* **2009**, *2010*, 1–26.
- (13) Hoffmann, R.; Woodward, R. B. *J. Am. Chem. Soc.* **1965**, *87*, 4388–4389.
- (14) Fukui, K. *Angew. Chem. Int. Ed. Engl.* **1982**, *21*, 801–809.
- (15) Klopman, G. *J. Am. Chem. Soc.* **1968**, *90*, 223–234.
- (16) Salem, L. *J. Am. Chem. Soc.* **1968**, *90*, 543–552.
- (17) Fukui, K. *Acc. Chem. Res.* **1971**, *4*, 57–64.
- (18) Fleming, I. In *Molecular Orbitals and Organic Chemical Reactions an Introduction*; John Wiley & Sons: Chichester, 2009.
- (19) Houk, K. N. *J. Am. Chem. Soc.* **1973**, *95*, 4092–4094.
- (20) Houk, K. N. *Acc. Chem. Res.* **1975**, *8*, 361–369.
- (21) Sauer, J.; Sustmann, R. *Angew. Chem. Int. Ed. Engl.* **1980**, *19*, 779–807.

- (22) Craig, D.; Shipman, J. J.; Fowler, R. B. *J. Am. Chem. Soc.* **1961**, *83*, 2885–2891.
- (23) Sauer, J. *Angew. Chem. Int. Ed. Engl.* **1966**, *5*, 211–230.
- (24) Alder, K.; Stein, G. *Angew. Chem.* **1937**, *50*, 510–519.
- (25) Wannere, C. S.; Paul, A.; Herges, R.; Houk, K. N.; Schaefer, H. F.; Von Ragué Schleyer, P. J. *Comput. Chem.* **2007**, *28*, 344–361.
- (26) Garca, J.; Mayoral, J.; Salvatella, L. *Eur. J. Org. Chem.* **2005**, *2005*, 85–90.
- (27) Furukawa, J.; Kobuke, Y.; Fueno, T. *J. Am. Chem. Soc.* **1970**, *92*, 6548–6553.
- (28) Weinreb, S. M.; Staib, R. R. *Tetrahedron* **1982**, *38*, 3087–3128.
- (29) Waldmann, H. *Synthesis* **1994**, *1994*, 535–551.
- (30) Jørgensen, K. A. *Angew. Chem. Int. Ed.* **2000**, *39*, 3558–3588.
- (31) Lin, L.; Liu, X.; Feng, X. *Synlett* **2007**, *2007*, 2147–2157.
- (32) Du, H.; Zhang, X.; Wang, Z.; Bao, H.; You, T.; Ding, K. *Eur. J. Org. Chem.* **2008**, *2008*, 2248–2254.
- (33) Pellissier, H. *Tetrahedron* **2009**, *65*, 2839–2877.
- (34) Lucas, B. S.; Gopalsamuthiram, V.; Burke, S. D. *Angew. Chem. Int. Ed.* **2007**, *46*, 769–772.
- (35) Memeo, M. G.; Quadrelli, P. *Chem. Eur. J.* **2012**, *18*, 12554–12582.
- (36) Grieco, P. A.; Parker, D. T. *J. Org. Chem.* **1988**, *53*, 3325–3330.
- (37) Hughes, R. A.; Thompson, S. P.; Alcaraz, L.; Moody, C. J. *J. Am. Chem. Soc.* **2005**, *127*, 15644–15651.
- (38) Behforouz, M.; Ahmadian, M. *Tetrahedron* **2000**, *56*, 5259–5288.
- (39) Abe, H.; Aoyagi, S.; Kibayashi, C. *J. Am. Chem. Soc.* **2000**, *122*, 4583–4592.
- (40) Ishida, H.; Shimizu, M.; Yamamoto, K.; Iwasaki, Y.; Yamada, S.; Yamaguchi, K. *J. Org. Chem.* **1995**, *60*, 1828–1833.
- (41) Zhu, G.-D.; Okamura, W. H. *Chem. Rev.* **1995**, *95*, 1877–1952.
- (42) Wipf, P.; Jung, J.-K. *J. Org. Chem.* **2000**, *65*, 6319–6337.
- (43) Lasne, M.-C.; Ripoll, J.-L. *Synthesis* **1985**, *1985*, 121–143.
- (44) Ichihara, A. *Synthesis* **1987**, *1987*, 207–222.
- (45) Klunder, A. J. H.; Zhu, J.; Zwanenburg, B. *Chem. Rev.* **1999**, *99*, 1163–1190.
- (46) Rickborn, B. In *Organic Reactions*; John Wiley & Sons, Inc., 2004.
- (47) Onyango, E. O.; Jacobi, P. A. *J. Org. Chem.* **2012**, *77*, 7411–7427.
- (48) Sauer, J.; Wiest, H. *Angew. Chem. Int. Ed. Engl.* **1962**, *1*, 269–269.
- (49) Carboni, R. A.; Lindsey, R. V. *J. Am. Chem. Soc.* **1959**, *81*, 4342–4346.
- (50) Boger, D. L. *Tetrahedron* **1983**, *39*, 2869–2939.

- (51) Boger, D. L. *Chem. Rev.* **1986**, *86*, 781–793.
- (52) Watt, D. S.; Corey, E. J. *Tetrahedron Lett.* **1972**, *13*, 4651–4654.
- (53) Chang, J. H.; Kang, H.-U.; Jung, I.-H.; Cho, C.-G. *Org. Lett.* **2010**, *12*, 2016–2018.
- (54) Boger, D. L.; Hong, J. *J. Am. Chem. Soc.* **1998**, *120*, 1218–1222.
- (55) Boger, D. L. *J. Heterocycl. Chem.* **1996**, *33*, 1519–1531.
- (56) Saracoglu, N. *Tetrahedron* **2007**, *63*, 4199–4236.
- (57) Churakov, A. M.; Tartakovsky, V. A. *Chem. Rev.* **2004**, *104*, 2601–2616.
- (58) Sauer, J.; Heldmann, D. K.; Hetzenegger, J.; Krauthan, J.; Sichert, H.; Schuster, J. *Eur. J. Org. Chem.* **1998**, *1998*, 2885–2896.
- (59) Müller, K.; Sauer, J. *Tetrahedron Lett.* **1984**, *25*, 2541–2544.
- (60) Boger, D. L. *J. Heterocycl. Chem.* **1996**, *33*, 1519–1531.
- (61) Boger, D. L.; Zhang, M. *J. Am. Chem. Soc.* **1991**, *113*, 4230–4234.
- (62) Blackman, M. L.; Royzen, M.; Fox, J. M. *J. Am. Chem. Soc.* **2008**, *130*, 13518–13519.
- (63) Devaraj, N. K.; Upadhyay, R.; Haun, J. B.; Hilderbrand, S. A.; Weissleder, R. *Angew. Chem. Int. Ed.* **2009**, *48*, 7013–7016.
- (64) Taylor, M. T.; Blackman, M. L.; Dmitrenko, O.; Fox, J. M. *J. Am. Chem. Soc.* **2011**, *133*, 9646–9649.
- (65) Lang, K.; Davis, L.; Wallace, S.; Mahesh, M.; Cox, D. J.; Blackman, M. L.; Fox, J. M.; Chin, J. W. *J. Am. Chem. Soc.* **2012**, *134*, 10317–10320.
- (66) Boger, D. L. *Tetrahedron* **1983**, *39*, 2869–2939.
- (67) Anderson, E. D.; Boger, D. L. *Org. Lett.* **2011**, *13*, 2492–2494.
- (68) Anderson, E. D.; Boger, D. L. *J. Am. Chem. Soc.* **2011**, *133*, 12285–12292.
- (69) Boger, D. L.; Kochanny, M. J. *J. Org. Chem.* **1994**, *59*, 4950–4955.
- (70) Boger, D. L.; Panek, J. S.; Duff, S. R. *J. Am. Chem. Soc.* **1985**, *107*, 5745–5754.
- (71) Catozzi, N.; Edwards, M. G.; Raw, S. A.; Wasnaire, P.; Taylor, R. J. K. *J. Org. Chem.* **2009**, *74*, 8343–8354.
- (72) Martin, J. C. *J. Heterocycl. Chem.* **1980**, *17*, 1111–1112.
- (73) Barczynski, P.; Van der Plas, H. C. *J. Org. Chem.* **1982**, *47*, 1077–1080.
- (74) Charushin, V. N.; Van der Plas, H. C. *J. Org. Chem.* **1983**, *48*, 2667–2671.
- (75) Marcelis, A. T. M.; Van der Plas, H. C. *J. Org. Chem.* **1986**, *51*, 67–71.
- (76) Frissen, A. E.; Marcelis, A. T. M.; Geurtsen, G.; De Bie, D. A.; Van der Plas, H. C. *Tetrahedron* **1989**, *45*, 5151–5162.
- (77) Frissen, A. E.; Marcelis, A. T. M.; Buurman, D. G.; Pollmann, C. A. M.; Van der Plas, H. C. *Tetrahedron* **1989**, *45*, 5611–5620.

- (78) Frissen, A. E.; Marcelis, A. T. M.; Van Der Plas, H. C. *Tetrahedron* **1989**, *45*, 803–812.
- (79) Marcelis, A. T. M.; Van Der Plas, H. C. *Tetrahedron* **1989**, *45*, 2693–2702.
- (80) Stolle, W. A. W.; Marcelis, A. T. M.; Koetsier, A.; Van der Plas, H. C. *Tetrahedron* **1989**, *45*, 6511–6518.
- (81) Frissen, A. E.; Geurtsen, G.; Marcelis, A. T. M.; Van der Plas, H. C. *Tetrahedron* **1990**, *46*, 595–606.
- (82) Tarasov, E. V.; Henckens, A.; Ceulemans, E.; Dahaen, W. *Synlett* **2000**, 625–626.
- (83) Neunhoef, H.; Werner, G. *Justus Liebigs Ann. Chem.* **1973**, 437–442.
- (84) Jojima, T.; Takeshiba, H.; Kinoto, T. *Chem. Pharm. Bull.* **1980**, *28*, 198–201.
- (85) Gruseck, U.; Heuschmann, M. *Tetrahedron Lett.* **1987**, *28*, 6027–6030.
- (86) Nesi, R.; Giomi, D.; Turchi, S.; Falai, A. *J. Chem. Soc., Chem. Commun.* **1995**, 2201.
- (87) Turchi, S.; Giomi, D.; Capaccioli, C.; Nesi, R. *Tetrahedron* **1997**, *53*, 11711–11720.
- (88) Turchi, S.; Nesi, R.; Giomi, D. *Tetrahedron* **1998**, *54*, 1809–1816.
- (89) Nesi, R.; Turchi, S.; Giomi, D.; Corsi, C. *Tetrahedron* **1998**, *54*, 10851–10856.
- (90) Ho, T.-L.; Hua Chang, M. *Tetrahedron Lett.* **1994**, *35*, 4819–4822.
- (91) Ho, T.-L.; Chang, M.-H. *J. Chem. Soc., Perkin Trans. 1* **1999**, 2479–2482.
- (92) Nomak, R.; Snyder, J. K. *Tetrahedron Lett.* **2001**, *42*, 7929–7933.
- (93) Haider, N.; Käferböck, J. *Tetrahedron* **2004**, *60*, 6495–6507.
- (94) Boger, D. L.; Wolkenberg, S. E. *J. Org. Chem.* **2000**, *65*, 9120–9124.
- (95) Bodwell, G. J.; Li, J. *Angew. Chem. Int. Ed.* **2002**, *41*, 3261–3262.
- (96) Oishi, E.; Taido, N.; Iwamoto, K.; Miyashita, A.; Higashino, T. *Chem. Pharm. Bull.* **1990**, *38*, 3268–3272.
- (97) Oishi, E.; Iwamoto, K.; Okada, T.; Suzuki, S.; Tanji, K.; Miyashita, A.; Higashino, T. *Chem. Pharm. Bull.* **1994**, *42*, 2219–2224.
- (98) Iwamoto, K.; Suzuki, S.; Oishi, E.; Tanji, K.; Miyashita, A.; Higashino, T. *Chem. Pharm. Bull.* **1995**, *43*, 679–682.
- (99) Türkmen, Y. E.; Montavon, T. J.; Kozmin, S. A.; Rawal, V. H. *J. Am. Chem. Soc.* **2012**, *134*, 9062–9065.
- (100) In *IUPAC Compendium of Chemical Terminology*; Nič, M.; Jirát, J.; Košata, B.; Jenkins, A.; McNaught, A., Eds.; IUPAC: Research Triangle Park, NC.
- (101) In *Lewis Acids in Organic Synthesis*; Yamamoto, H., Ed.; 2008.

- (102) Mukaiyama, T.; Shiina, I.; Iwadare, H.; Saitoh, M.; Nishimura, T.; Ohkawa, N.; Sakoh, H.; Nishimura, K.; Tani, Y.; Hasegawa, M.; Yamada, K.; Saitoh, K. *Chem. Eur. J.* **1999**, *5*, 121–161.
- (103) Stephan, D. W.; Erker, G. *Angew. Chem. Int. Ed.* **2010**, *49*, 46–76.
- (104) Brown, H. C.; Schlesinger, H. I.; Cardon, S. Z. *J. Am. Chem. Soc.* **1942**, *64*, 325–329.
- (105) Greb, L.; Oña-Burgos, P.; Schirmer, B.; Grimme, S.; Stephan, D. W.; Paradies, J. *Angew. Chem. Int. Ed.* **2012**, *51*, 10164–10168.
- (106) Yates, P.; Eaton, P. *J. Am. Chem. Soc.* **1960**, *82*, 4436–4437.
- (107) Corey, E. J.; Weinshenker, N. M.; Schaaf, T. K.; Huber, W. *J. Am. Chem. Soc.* **1969**, *91*, 5675–5677.
- (108) Corey, E. J.; Ensley, H. E. *J. Am. Chem. Soc.* **1975**, *97*, 6908–6909.
- (109) Hashimoto, S.; Komeshima, N.; Koga, K. *J. Chem. Soc., Chem. Commun.* **1979**, 437.
- (110) Corey, E. J. *Angew. Chem. Int. Ed.* **2002**, *41*, 1650–1667.
- (111) Jørgensen, K. A. *Angew. Chem.* **2000**, *39*, 3558–3588.
- (112) Fringuelli, F.; Piermatti, O.; Pizzo, F.; Vaccaro, L. *Eur. J. Org. Chem.* **2001**, *2001*, 439–455.
- (113) Lee, A.; Stewart, J. D.; Clardy, J.; Ganem, B. *Chem. Biol.* **1995**, *2*, 195–203.
- (114) Xue, Y.; Lipscomb, W. N. *PNAS* **1995**, *92*, 10595–10598.
- (115) Ganem, B. *Angew. Chem. Int. Ed. Engl.* **1996**, *35*, 936–945.
- (116) Taylor, M. S.; Jacobsen, E. N. *Angew. Chem. Int. Ed.* **2006**, *45*, 1520–1543.
- (117) Connon, S. J. *Chem. Commun.* **2008**, 2499.
- (118) Akiyama, T.; Itoh, J.; Fuchibe, K. *Adv. Synth. Catal.* **2006**, *348*, 999–1010.
- (119) Takemoto, Y. *Chem. Pharm. Bull.* **2010**, *58*, 593–601.
- (120) Schreiner, P. R. *Chem. Soc. Rev.* **2003**, *32*, 289.
- (121) Pihko, P. M. *Angew. Chem. Int. Ed.* **2004**, *43*, 2062–2064.
- (122) Okino, T.; Hoashi, Y.; Takemoto, Y. *J. Am. Chem. Soc.* **2003**, *125*, 12672–12673.
- (123) Hoashi, Y.; Okino, T.; Takemoto, Y. *Angew. Chem. Int. Ed.* **2005**, *44*, 4032–4035.
- (124) Akiyama, T.; Morita, H.; Fuchibe, K. *J. Am. Chem. Soc.* **2006**, *128*, 13070–13071.
- (125) Pindur, U.; Lutz, G.; Otto, C. *Chem. Rev.* **1993**, *93*, 741–761.
- (126) Biallas, M. J.; Shriver, D. F. *J. Am. Chem. Soc.* **1966**, *88*, 375–376.
- (127) Beauchamp, A. L.; Olivier, M. J.; Wuest, J. D.; Zacharie, B. *J. Am. Chem. Soc.* **1986**, *108*, 73–77.
- (128) Beauchamp, A. L.; Olivier, M. J.; Wuest, J. D.; Zacharie, B. *Organometallics* **1987**, *6*, 153–156.

- (129) Wuest, J. D. *Acc. Chem. Res.* **1999**, *32*, 81–89.
- (130) Reilly, M.; Oh, T. *Tetrahedron Lett.* **1994**, *35*, 7209–7212.
- (131) Reilly, M.; Oh, T. *Tetrahedron Lett.* **1995**, *36*, 217–220.
- (132) Reilly, M.; Oh, T. *Tetrahedron Lett.* **1995**, *36*, 221–224.
- (133) Ooi, T.; Takahashi, M.; Maruoka, K. *J. Am. Chem. Soc.* **1996**, *118*, 11307–11308.
- (134) Maruoka, K. *Catal. Today* **2001**, *66*, 33–45.
- (135) Maruoka, K. *Pure Appl. Chem.* **2002**, *74*, 123–128.
- (136) Maruoka, K. *Bull. Chem. Soc. Jpn* **2009**, *82*, 917–930.
- (137) Hashimoto, T.; Omote, M.; Kano, T.; Maruoka, K. *Org. Lett.* **2007**, *9*, 4805–4808.

2 Objectives of the Thesis

The IEDDA reaction of 1,2-diazines presents for instance a facile route to complex substituted aromatic compounds (Scheme 49).

Scheme 49. A convenient access to complex substituted aromatic compounds via IEDDA reaction of 1,2-diazines.

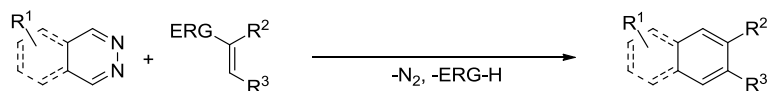

Despite the immense effort devised into this field of research, the reaction of 1,2-diazines as the diene is only scarcely disclosed and focus mainly on 1,2-diazines substituted by electron withdrawing groups or intramolecular reactions. The reason for this is the very high lying LUMO energy of unsubstituted diazines, which makes them hardly reactive even towards electron rich dienophiles. To activate the diazine as the diene in a IEDDA reaction a catalyst had to be developed to serve the purpose of lowering the LUMO energy of the 1,2-diazine enabling the reaction with a electron rich dienophile. A general method to achieve the decrease of the energy of a LUMO is the utilization of a Lewis acid. Based on the pre-evaluated bidentate Lewis acid as catalyst for the IEDDA reaction of 1,2-Diazines the method had to be developed, consequently leading to the following aims, set as cornerstones of this thesis:

- (1) The establishment of a new more direct and convenient route for the synthesis of 5,10-dimethyl-5,10-dihydroboranthrene to obtain useful amounts of the catalyst.
- (2) The corroboration of catalysis of the IEDDA reaction of 1,2-diazines by the bidentate Lewis acid.
- (3) The investigation of the scope of the bidentate Lewis acid catalyzed IEDDA reaction on both the dienophile as well as on the diene side.
- (4) The elucidation of the mechanism of the Lewis acid catalyzed IEDDA reaction by experimental and computational techniques.
- (5) The examination of an application of the catalytic IEDDA reaction.

3 Results and Discussion

3.1 The development of a catalyst for the IEDDA reaction of 1,2-diazines

3.1.1 Introduction

The IEDDA reaction of 1,2-diazines described above requires harsh conditions. The diazine needs to be substituted by one or more EWGs or the cycloaddition is conducted in an intramolecular fashion. Altogether, considerably limits the scope and, therefore, the applicability of the IEDDA reaction of 1,2-diazines. Consequently, a catalyzed version of this reaction would enter a versatile synthesis of highly substituted aromatics (Scheme 50).

Scheme 50. IEDDA reaction of 1,2-diazines for the synthesis of substituted aromatics.

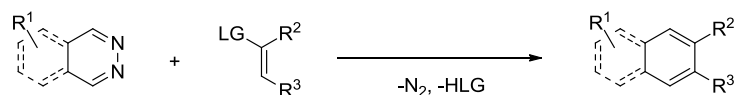

Since the poor reactivity is associated with the high LUMO energy of the 1,2-diazine, its energy must be lowered. The task of decreasing the LUMO energy is commonly accomplished by coordination with a Lewis acid. Thus, the idea of activating the 1,2-diazine **A** by a simultaneous complexation of a bidentate Lewis acid **B** with both of the vicinal nitrogen atoms was formulated (Scheme 51).

Scheme 51. Activation of a 1,2-diazine by multipoint complexation with a bidentate Lewis acid.

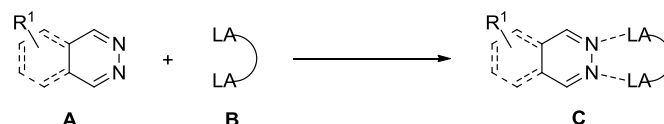

Furthermore the catalytic cycle has been envisioned based on the widely accepted mechanism described in Scheme 52 as following: The bidentate Lewis acid **B** complexes the incoming 1,2-diazine **A**, the formed complex **C** and dienophile **D** undergo a IEDDA reaction to the adduct **E** which further eliminates molecular nitrogen and consecutively the leaving group (LG) to yield the final aromatic product **F** and regenerating the Lewis acid catalyst **B** (Scheme 52).^{138–141}

Scheme 52. Envisioned Catalytic cycle of a bidentate Lewis acid catalyzed IEDDA reaction of 1,2-diazine

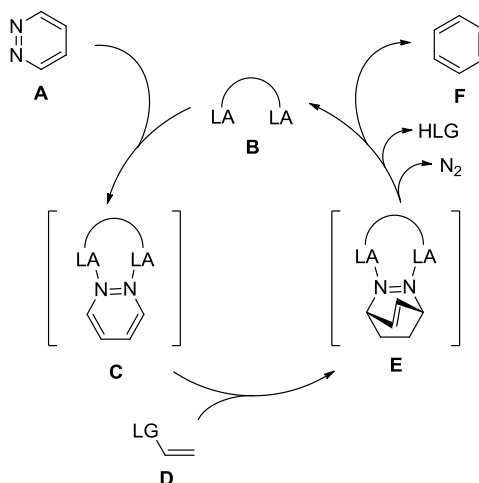

A variety of different binuclear complexes with pyridazine or phthalazine are known bearing $\text{Cu}^{142,143}$, Fe^{144} , Sn^{145} , Rh^{146} , Pt^{147} as Lewis acid. An indium based bidentate Lewis acid **174** was utilized by Gabaï et al. to selectively bind 1,2-diazine **111** in the presents of the other two diazine isomers, 1,3- and 1,4-diazine.¹⁴⁸ The reason for the higher affinity of the Lewis acid towards 1,2-diazine lies in the bidentate binding mode (Scheme 53). This was also observed in the solid state structure of the complex **175**.

Scheme 53. Bidentate complexation of an indium Lewis acid to a 1,2-diazine.

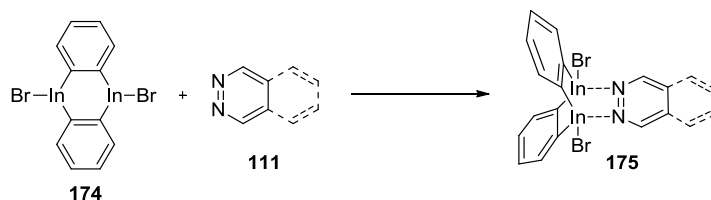

A boron based bidentate Lewis acid/1,2-diazine complex **178** was synthesized by Piers and co-workers¹⁴⁹ (Scheme 54). This intensely colored adduct is isoelectronic with triphenylene. DFT calculations reveal the localization of the LUMO mainly to be on the 2,2'-diborabiphenyl moiety.

Scheme 54. Complexation of pyridazine by a bidentate boron Lewis acid.

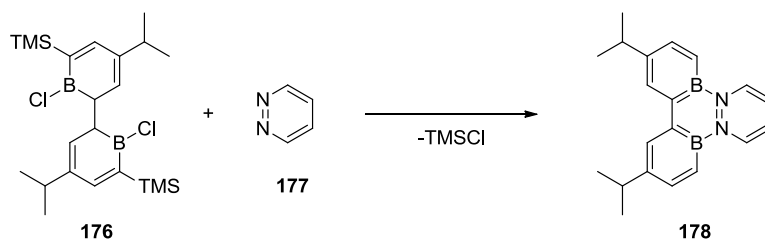

In parallel to this work, Wagner and co-workers demonstrated the synthesis of boron doped π -conjugated polymers **182** via hydroboration of alkyne **181** with 9,10-diboranthracene **179** (Scheme 55).¹⁵⁰ Furthermore, the formation of a complex **180** with 1,2-diazine **111** was shown. They expected an analogous complex of their polymer **182** to exhibit enhanced properties such as better stability with respect to oxidation and hydrolysis. But such a complex has not been described so far and complex **180** was not further investigated.

Scheme 55. Dihydroboranthrene as versatile building block for boron doped π -conjugated polymers.

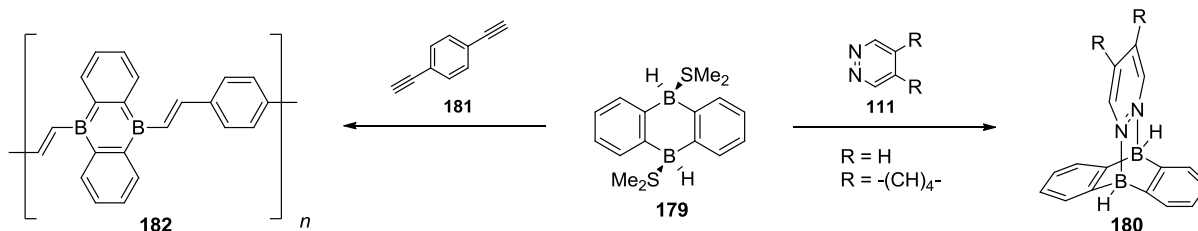

In conclusion, literature suggested a boron based Lewis acid to be most promising. For the evaluation of potential boron based bidentate Lewis acids as catalysts for the IEDDA reaction of 1,2-diazines the three existing types **185**, **186** and **187** have been calculated by DFT on b3lyp/6-31g(d,p) level of theory (Figure 12: selected examples).¹⁵¹

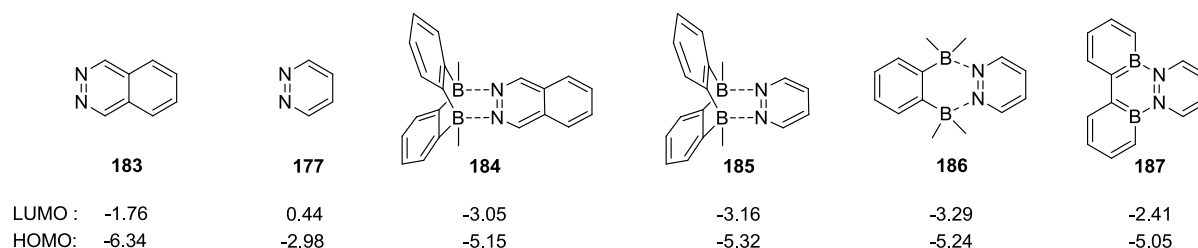
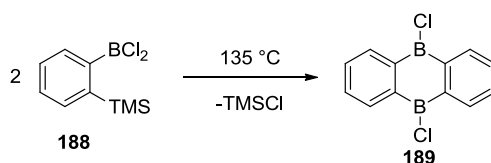

Figure 12. Pyridazine and phthalazine in the complexation with Lewis acids with FMO energies in eV. The LUMO energies of all three types of complexes **185** – **187** exhibit a large decrease compared to the uncomplexed pyridazine. The same effect was also computed from the complex of boranthrene and phthalazine **184**. The calculations revealed that not only the LUMO of complex **187** is rather located on the Lewis acid entity than on the diazine, but also its energy is higher than the LUMOs of the remaining complex. Since the FMO energies of complex **185** and **186** are similar and both of their LUMOs are located on the diazine, Lewis acid **192** was chosen to be studied as a catalyst due to its possible smaller spatial extend over the faces of the diazine moiety in complex **185**.

3.1.2 Synthesis of the bidentate Lewis acid catalyst

The dihydroboranthrene framework was first synthesized in the mid 60's¹⁵² from a mercury compound and little later it was synthesized by Siebert et al. from a borate.¹⁵³ Siebert and co-workers used the dihydroboranthrenes to form complexes with a variety of different transition metals.^{154–156} The first practically appealing method to synthesize dichloro-dihydroboranthrene **189** was devised by Kaufmann in the late 80's by the dimerization of neat *o*-boryltrimethylsilylbenzene **188** at 135 °C.¹⁵⁷

Scheme 56. Dimerization of boron compound **188** to dichloro dihydroboranthrene **189**.



Kaufmann's approach was elected as the most suitable one. The dihydroboranthrene **192** was prepared in four steps (Scheme 57). The synthesis commenced with a Li/Br exchange and consecutive silylation to result in 1,2-bis(trimethylsilyl)benzene (**191**).¹⁵⁸ One of the TMS-groups was selectively substituted with BCl₃ to give the monoboronated product **188** according to a procedure published also by Kaufmann.¹⁵⁹ The dimerization key step was conducted at 135 °C for 24 h as shown below¹⁵⁷ and the final dimethyl dihydroboranthrene **192** was achieved by methylation with methyl lithium.¹⁵⁴

Scheme 57. First generation synthesis of dimethyl dihydroboranthrene by a four step sequence.

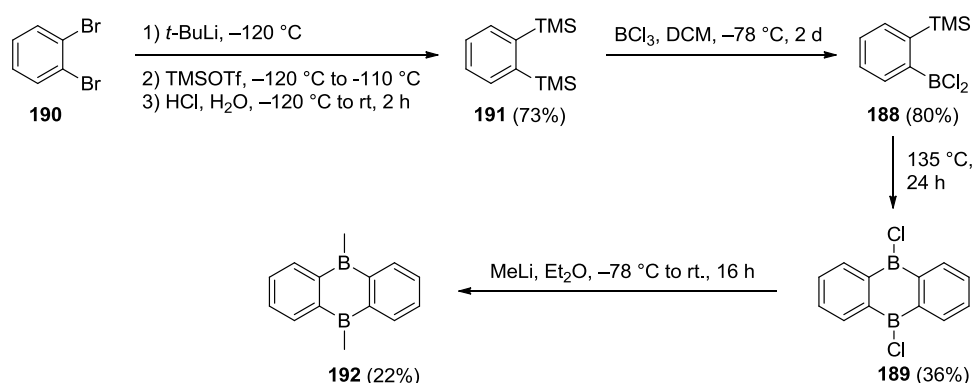

However, for the preparation of several hundred milligrams, the four-step sequence with an overall yield of less than 5% seemed not appropriate. Therefore, the synthesis was optimized to provide a very robust route that yielded the desired bidentate Lewis acid in only three steps (Scheme 58). By doing so, simple cheap starting materials are used and the reactions can be done on a gram scale. The preparation started with an Fe-catalyzed Grignard reaction of 1,2-

dibromobenzene (**190**), which has been developed to suit herein purposes.¹⁶⁰ Although this new protocol furnishes 1,2-bis-(TMS)-aryl compounds only in moderate yields, it allows for a much easier multi-gram preparation of the desired intermediate **191**. Next, the original two-step process to access the dichloroboranthrene **189** was shortened to one step. For this transformation it is critical to use 1,2-dichloroethane as solvent at high temperatures in a sealed pressure tube. After the reaction is complete and cooled to room temperature, the air and moisture sensitive product is obtained as white needles, which after washing with hexanes can be used without further purification. The final attachment of the Me-group is achieved by using AlMe_3 to yield the desired bidentate Lewis acid **192**. AlMe_3 as methylation reagent for similar compounds was presented by Siebert et al.¹⁶¹ and it showed to be much more successful than MeLi.

Scheme 58. Second generation three-step preparation of the bidentate Lewis acid **192**.

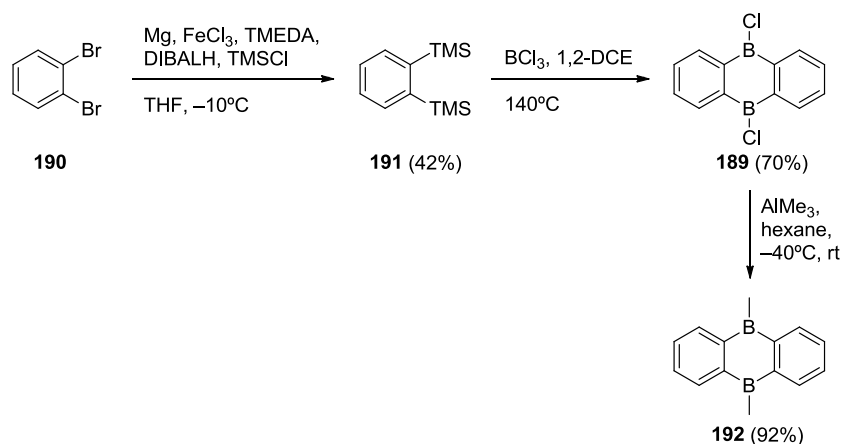

With the desired Lewis acid in hand complexation studies with 1,2-diazines were conducted to validate the electron withdrawing effect, predicted by the calculations. Titration of phthalazine **183** to a solution of **192** resulted in the formation of a 1:1 complex **184** of the 1,2-diazine with the Lewis acid (Scheme 59).

Scheme 59. Complexation experiment of the bidentate Lewis acid **192** and phthalazine **183**.

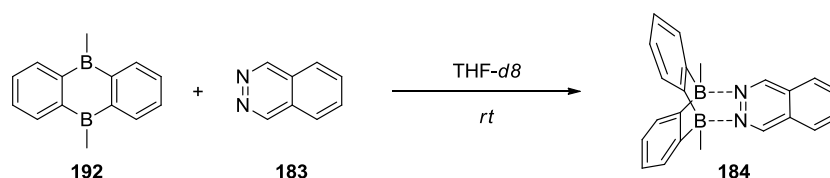

$^1\text{H-NMR}$ spectroscopy confirmed the calculations: The electron withdrawal from the 1,2-diazine can be observed in a low field shift of the diazine protons and, accordingly, a high field shift of the protons of the complexing Lewis acid (Figure 13). When an electron rich

dienophile such as the oxazolidine **195** is treated with the Lewis acid **192** also a complexation on the N-atom was observed. However, upon addition of phthalazine **183** the complexation is completely shifted to the 1,2-diazene.

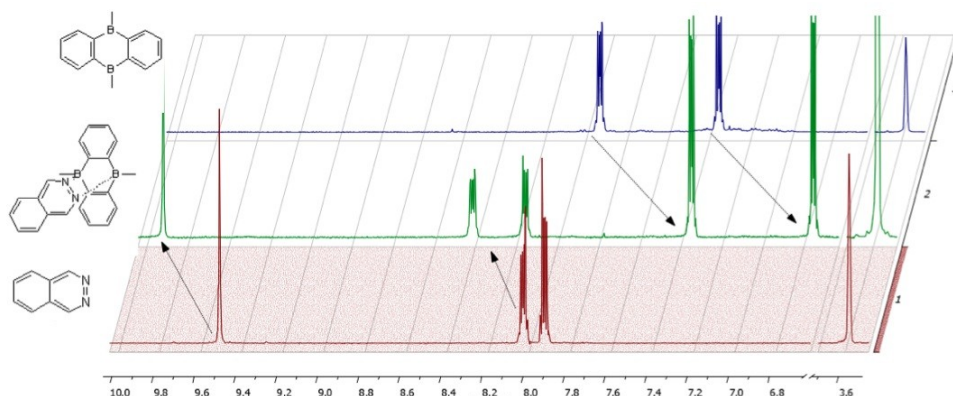

Figure 13. Stacked low field region of $^1\text{H-NMR}$ spectra of complex **184** (in green), phthalazine **183** (in red), and free Lewis acid **192** (in blue). Singlet of $\text{THF-}d_8$ ($\delta = 3.58$ ppm) is used as the reference peak.

Furthermore, the complex **184** of phthalazine with the bidentate Lewis acid was successfully crystallized and studied by X-ray analysis (Figure 14).¹⁶² While this does not definitively prove the bidentate nature of the coordination in solution, it is consistent with such findings described above.

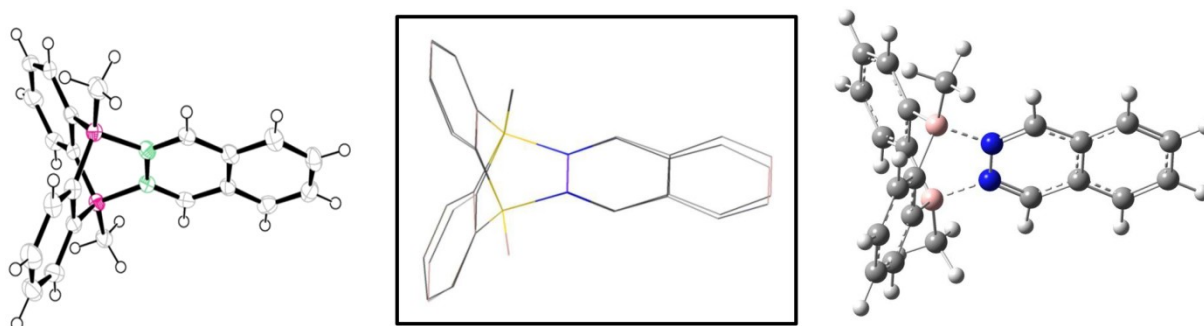

Figure 14. Solid state (left) and DFT (right) structures of the bidentate Lewis acid-phthalazine complex **184** with their overlap (middle).

Beside a slight twist in the solid state structure the calculated structure is almost congruent. Furthermore, the overlay exhibits a very precise reproduction of the binding characteristic of boron and nitrogen with a deviation of only 0.013 Å in bond length (Figure 14).

Both computation and experiment, in solution or in solid state, illustrated a bidentate binding. And this binding, as shown by DFT-calculations lowers the LUMO energy of the complexed 1,2-diazine i.e. electron density is withdrawn from the 1,2-diazine which was further shown by a significant low-field shift of its protons in the $^1\text{H-NMR}$ spectrum.

The above investigations, consequently showed that the chosen bidentate Lewis acid **192** fulfilled the expectations formulated in Scheme 51. Therefore, the bidentate Lewis acid **192** was tested as a catalyst in a model IEDDA reaction of phthalazine **183** with oxazolidine **195**. Oxazolidine **195** was synthesized by methylation and successive elimination from 2-ethyl-4,5-dihydrooxazole **193** (Scheme 60).^{163–165}

Scheme 60. Synthesis of (*Z*)-2-ethylidene-3-methyloxazolidine (**195**).

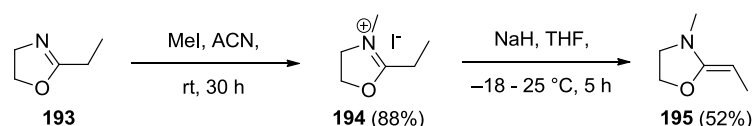

Hünig's base (DIEA) was added as a scavenger for protons, which might catalyze the acid promoted polymerization of the oxazolidine **195**.^{164,165} The reaction was first tested with 10 mol% of the Lewis acid **192**. In parallel, the same reaction was also conducted with 5% and 2.5 mol% of the catalyst **192** using 1.5 equivalent of the oxazolidine **195** (Scheme 61).

Scheme 61. First catalysis of an IEDDA reaction of phthalazine **183** and **195**

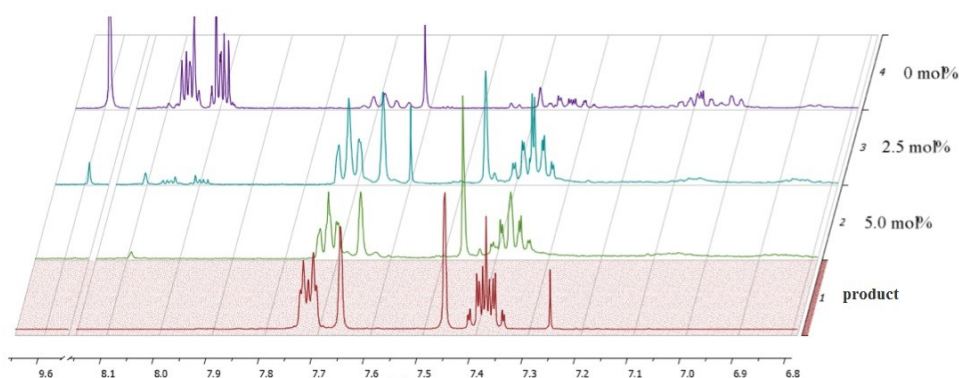
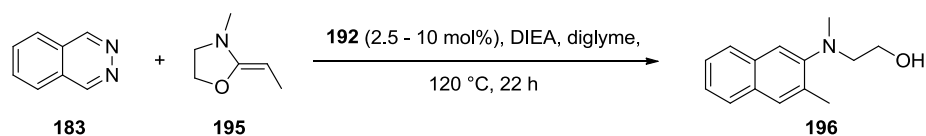

Figure 15. Stacked aromatic region of ¹H-NMR spectra (in CDCl₃) of pure product (red), catalyzed reactions with 5.0 mol% (green) and 2.5 mol% (cyan), and the uncatalyzed reaction (purple).

The comparison of the catalyzed reaction and the non-catalyzed reaction clearly shows the ability of the bidentate Lewis acid to promote the IEDDA reaction of phthalazine. After the same reaction time, when nearly no conversion is observed without the catalyst, the addition of only 5 mol% of Lewis acid **192** results in full conversion according to ¹H-NMR (isolated yield: 42%). This proves an acceleration of the intended IEDDA reaction in the presence of the catalyst **192**.

The reaction of phthalazine **183** with oxazolidine **195** in the presence of a monodentate Lewis acid such as $\text{BF}_3 \cdot \text{Et}_2\text{O}$ followed a totally different reaction path. No IEDDA product **196** was detected in $^1\text{H-NMR}$ nor GC-MS analysis. All results point to products resulting from a nucleophilic addition of the oxazolidine **195** similar to the described nucleophilic addition of alkyl lithium reagents mediated by $\text{BF}_3 \cdot \text{Et}_2\text{O}$.¹⁶⁶

3.1.3 Scope of the bidentate Lewis acid catalyzed IEDDA reaction of 1,2-diazines

The success of the catalyzed IEDDA reaction of oxazolidine **195** and phthalazine **183** initiated the evaluation of the substrate scope. Therefore, a number of other electron rich dienophiles such as enolates, ketene acetals, enamines or even alkynes in case of activated phthalazine substrate have been used to access substituted naphthalenes. Due to the best results obtained by the addition of 5 mol% catalyst in Figure 15 this amount was as well taken for most of the following reactions.

3.1.3.1 Enols as dienophiles

Different dienophiles containing an enol moiety were subjected to the catalyzed IEDDA reaction with phthalazine (**183**) (Table 1).



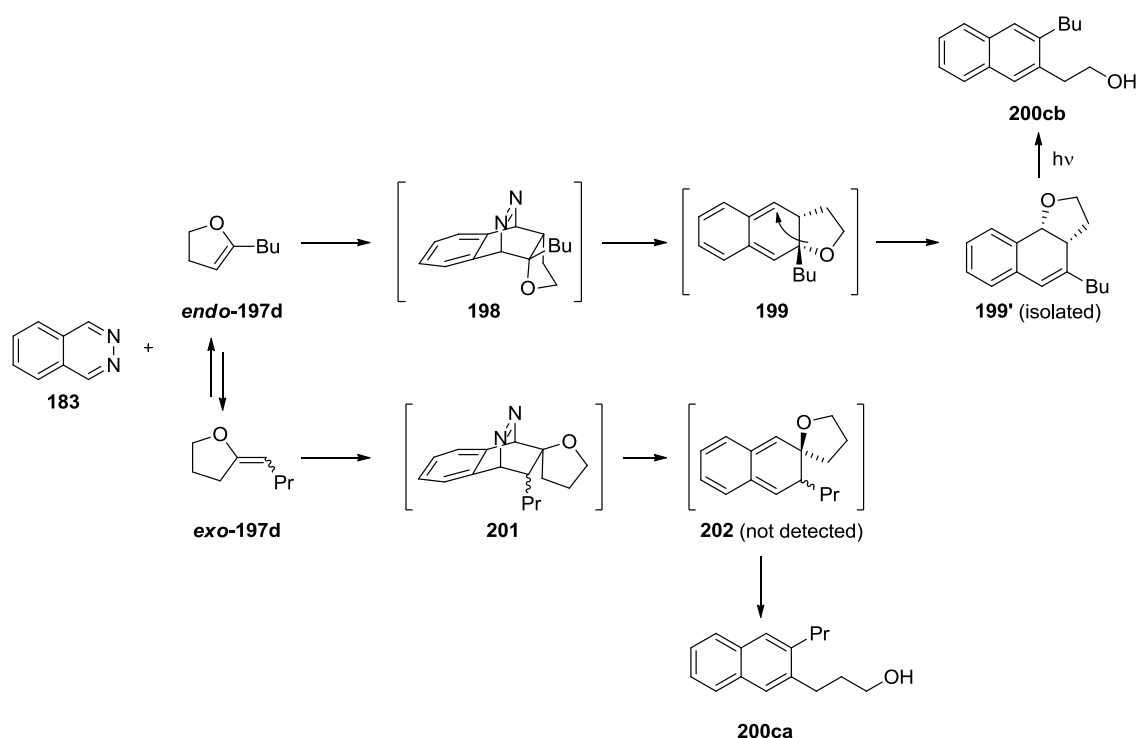



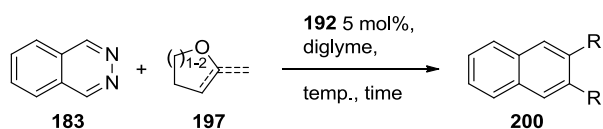

Scheme 62. *Endo/exo*-isomerization of the double bond of **197** resulting in two different isomers **200da** and **200db**.

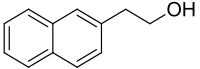

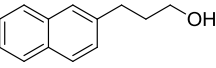
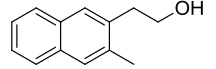
Besides the oxazolidine **195** less activated dienophiles such as dihydrofurans **197a-d** can also be effectively transformed. In the case of 2-*n*Bu-dihydrofurane **197d** as dienophile an *exo/endo* isomerization¹⁶⁷ occurs, where both isomers undergo an IEDDA reaction by different pathways (Scheme 62). *Exo-197d* follows the usual pathway, forming DA adduct **198** and consecutive cycloreversion produces substituted naphthalene **200cb** upon rearomatization. The *endo*-isomer **197d** first also reacts via IEDDA and retro DA reaction to give **199** which was originally expected to be the isolated intermediate as shown by NMR spectroscopy, GC-MS and elementary analysis.

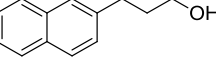
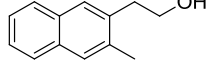
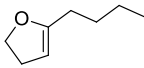
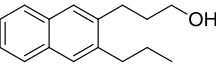
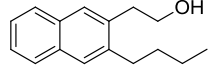
Table 1. Different dienophiles in the Lewis acid catalyzed IEDDA reaction of phthalazine (**183**).

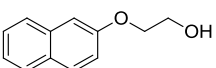

| Entry | Enols | Temp. / time | Product ^[a] (yield) |
|------------------|--|---------------|---|
| 1 |  197a | 170 °C / 72 h |  200a (43%) |
| 2 ^[e] |  197b | 160 °C / 48 h |   200ba/200bb (75%, 3:1) |
| 3 |  197c | 160 °C / 48 h |   200ba/200bb (68%, 4.5:1) |
| 4 |  197d | 160 °C / 48 h |   200ca/200cb (73%, 1.5:1) |
| 5 |  197e | 160 °C / 10 h |  200d (45%) |
| 6 |  197f | 160 °C / 48 h | No reaction |

[a] Phthalazine (1.00 eq.), dienophile (2.00-3.00 eq.), catalyst (5 mol%), diglyme/Hünigs base (3:1); work-up included UV-irradiation.

However, no 2D-NMR spectra or a solid state structure has been reported. And since **199** displays a very reactive *o*-quinodimethan species prone to undergo different rearrangements (Scheme 62). The isolated structure **199** is revised to be a constitutional isomer **199'** resulting from an [1,9]-sigmatropic rearrangement very unexpected at this time of the investigations (see Chap. 3.5). Via the “*exo*-route”, an according sigmatropic rearrangement is due to severe sterical hindrance not viable and therefore the elimination is favored. Treatment of a sample of isolated intermediate **199'** with light (Rayonett reactor, 300 nm) induced the elimination process to cleanly form the desired naphthalene product **200cb**.¹⁶⁸ Hence, in order to facilitate the purification all reactions involving enols were subjected to UV-light irradiation.

3.1.3.2 Enamines from ketones as dienophiles

In contrast to enols, enamines are more activated for the IEDDA reaction. For example, Sauer et al. reported, that *N,N*-dimethylcyclopent-1-enamine is 2.2×10^3 times more reactive than 2,3-dihydrofuran (**197a**). Enamines give in good to very good yield the desired substituted naphthalenes in the bidentate Lewis acid catalyzed IEDDA reaction (Table 2, Entries 2-4).

Table 2. Different enamines in the Lewis acid catalyzed IEDDA reaction of phthalazine.

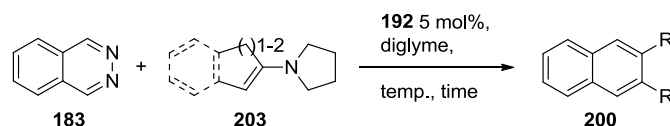

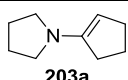
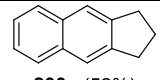
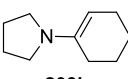
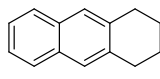
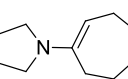
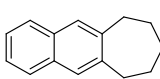
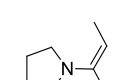
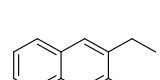
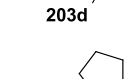
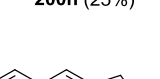
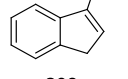
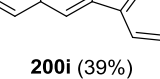
| Entry | Enamine ^[b] | Temp. / time | Product ^[a] (yield) |
|------------------|---|----------------|--|
| 1 |  203a | 55 °C / 2.5 d |  200e (52%) |
| 2 ^[c] |  203b | 90 °C / 2.5 d |  200f (80%) |
| 3 |  203c | 80 °C / 2.5 d |  200g (85%) |
| 4 |  203d | 130 °C / 2.5 d |  200h (25%) |
| 5 |  203e | 110 °C / 2.5 d |  200i (39%) |
| 6 |  203f | 110 °C / 2.5 d |  200i (26%) |

[a] Phthalazine (1.00 eq.), enamine (3.00 eq.), catalyst (5 mol%), diglyme; work-up with *m*CPBA. [b] All enamine were prepared in situ from the corresponding ketone and pyrrolidine unless stated otherwise. [c] The enamine was separately prepared prior to use.

Also, in some of the enamines studied, products were isolated before re-aromatization occurred. For example, the reaction of phthalazine **183** and **203a** gave the adduct **204** in 86% yield (Scheme 63). Similar results were reported by Boger and coworkers in the IEDDA reaction of 1,2,4-triazene with enamines.¹⁶⁹ Treatment of the crude mixture with *m*CPBA induced a Cope-elimination to produce the desired naphthalene.¹⁷⁰

Scheme 63. Reaction to intermediate **204** and rearomatization to the cycloaddition product **200e**.

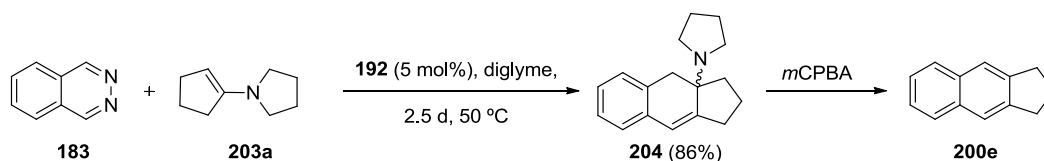

It is noteworthy, that the enamines can be prepared in situ from the corresponding ketone and a secondary amine (in this case pyrrolidine), which allows the catalyzed IEDDA reaction of enamines that are difficult to isolate, such as enamine **203d**.^{171,172} Therefore, the activity of the catalyst is not disturbed by the presence of the free amine or the water formed during this process. In fact, the addition of molecular sieves or MgSO₄ to remove the water actually had adverse effects and inhibited the reaction. Thus, enamine **203d** provided the corresponding 2,3-substituted naphthalene **200h** (Table 2, entry 4). With this procedure, basically any ketone that is able to form an enamine can be incorporated into an aromatic structure. For example, the catalyzed IEDDA reaction of enamines **203e** and **203f** derived from 1- and 2-indanone give, in one step, access to tetracyclic ring structures (Table 2, entries 5 & 6) that display the core of the natural product kinafluorenone (**205**).¹⁷³

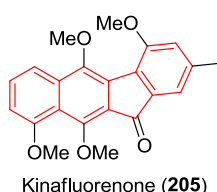
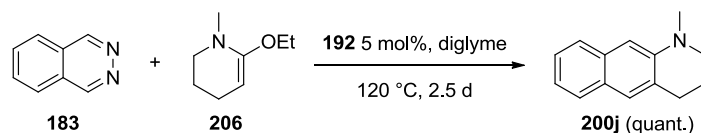

Figure 16. Accessible fluorene core structure of natural product.

In addition to enamines, *N,O*-ketene acetal **206** also served as excellent substrate for the catalyzed IEDDA reaction (Scheme 64). Although elimination of either the N or the O residue is feasible, only the extrusion of ethanol was observed, giving rise to annelated tetrahydroquinoline **200j** in quantitative yield.

Scheme 64. Cycloaddition of *N,O*-ketene acetal **206** and phthalazine **183**.



The structural theme of tetrahydroquinoline **200j** is present in compounds, such as kalasinamide¹⁷⁴ (**208**) etc. (Figure 17), which was isolated in 2000 from the acetone extract of *Polyalthia suberosa* and a total synthesis occurred recently.¹⁷⁵

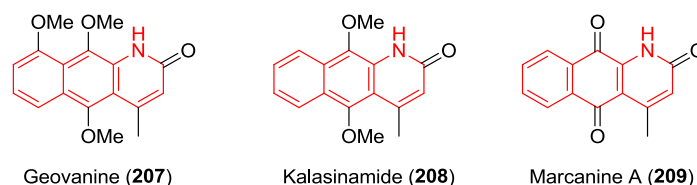
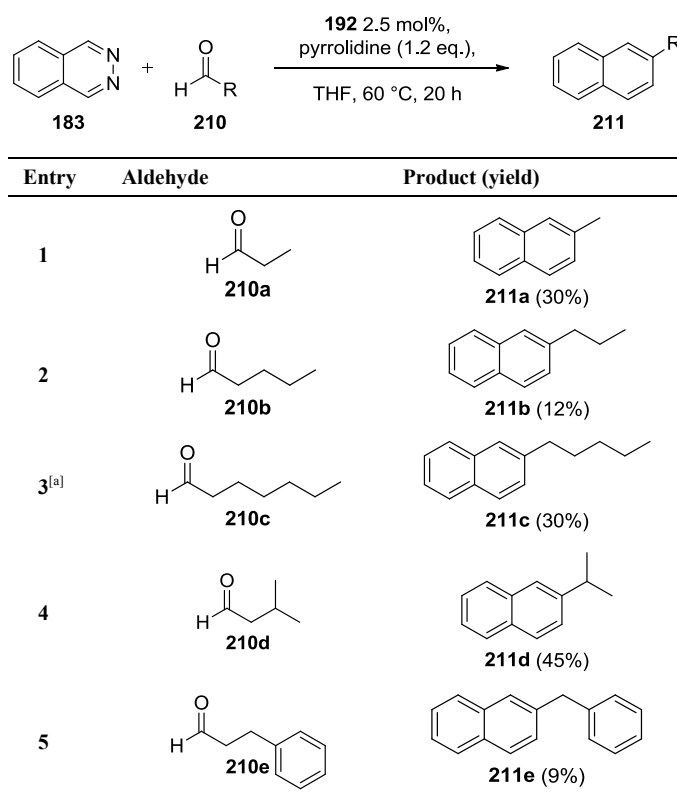

Figure 17. Core structures accessible via catalyzed IEDDA reaction featured in natural products.

3.1.3.3 Enamines from aldehydes as dienophiles

Since the in situ formation of enamines from ketones did not interfere with the catalyst's activity the catalyzed IEDDA reaction of aldehyde derived enamine was carried out. And to verify the utility of aldehydes different substitution pattern were chosen and submitted to the catalyzed IEDDA reaction. Besides alkyl chains also aromatic groups were introduced. All aldehydes were transformed to the corresponding naphthalene (Table 3).

Table 3. Aldehyde as substrates for the bidentate Lewis acid catalyzed IEDDA reaction.



[a] The enamine was derived from *N*¹,*N*²-dimethylethane-1,2-diamine.

Interestingly, *n*-alkyl aldehydes gave the desired product only in low yield. The phthalazine (**183**) starting material, however, was consumed. Additionally, considerable gas evolution was observed, which hints to a successful IEDDA reaction. Therefore, the explanation for the low yield seems not to be the direct catalyzed IEDDA reaction but rather due to side reaction in the enamine formation or the subsequent IEDDA reaction with stable intermediates.¹⁷⁶ A

slightly improved outcome could be observed for substrate **210d**, which is distinguished by a Me-substituent in γ -position. The additional steric hindrance might slow down the side reaction and favor the desired IEDDA transformation. For heptanal (**210c**) only traces of product were found by GCMS, if the standard, pyrrolidine was used for the enamine formation. The use of N^1,N^2 -dimethylethane-1,2-diamine,¹⁷⁷ however, gave the desired 2-*n*-penylnaphthalene (**211c**) in an improved yield of 30% as the required elimination is accelerated due to an intramolecular pathway. Therefore, other aldehydes were assayed in the bidentate Lewis acid catalyzed IEDDA reaction, which contained a Me-substituent in β -position (Table 4).

Table 4. β -Branched aldehydes as substrates for the bidentate Lewis acid catalyzed IEDDA reaction.

| Entry | Aldehyde | Product ^[a] (yield) |
|------------------|---|---|
| 1 | | |
| 2 | | |
| 3 ^[b] | | |
| 4 | | |
| 5 | | |
| | R' = SMe 210j R' = OH 210k | R' = SMe 211j (-%) R' = OH 211k (-%) |

[a] 5.0 mol% catalyst, if not stated other wise. [b] 2.5 mol% catalyst.

With this arrangement, elimination to the corresponding naphthalene skeleton is still possible. However, the corresponding enamine will contain an isopropyl-type substitution, increasing the steric demand considerably. In the case of the Me-analog of **210f** the desired naphthalene derivative could be isolated in 64% (Table 4, entry 1). Additionally, other functional groups have been introduced, which also bear the potential of interaction with the Lewis acid catalyst. The tertiary alcohol can be problematic in Lewis acid catalysis as they could

eliminate. However, in the presence of the bidentate Lewis acid the substrate derived from **210g** is converted in good yield to the desired product (Table 4, entry 2). Also an ester group was included as a side chain (Table 4, entry 3). Such a substrate also has the potential to coordinate with its two oxygen atoms to the bidentate Lewis acid. Nevertheless, the product was isolated in 41%, supporting the high specificity of the bidentate binding event of the catalyst with the 1,2-diazine moiety. A more challenging starting material is the furan analog, as it is itself a good diene in the normal Diels-Alder reaction. Although the product **211i** is observed, the yield is rather low (Table 4, entry 4). Thioether **210j** was tested as well and although all phthalazine was consumed, no product **211j** could be isolated. Similar attempts to promote the IEDDA reaction with β -hydroxy aldehyde **210k** also failed. As mentioned above, the reason is not the reactivity in the IEDDA reaction. The aldehyde itself undergoes a variety of transformations, which proceed before the cycloaddition event. All these side products are now themselves substrates for the IEDDA reaction. Therefore, although phthalazine **183** was consumed no product could be isolated.

Furthermore, terpene based structures have been chosen as substrates for the catalyzed IEDDA reaction. Such dienophiles should give access to an interesting alkenyl-aryl motive, which has been prepared before in multiple steps.¹⁷⁸⁻¹⁸² Citronellal has been tested in the bidentate Lewis acid catalyzed IEDDA reaction with phthalazine **183** (Scheme 65). The reaction proceeded smoothly and after 1 d no starting materials was observable anymore. The product showed in this case a mixture of the aromatized naphthalene derivative **211i** and products, which still contain the amine functionality (by GC/MS). After column chromatography the desired product **211i** could be isolated in 27% yield, the remaining fraction being amine products. Increasing the reaction temperature did favor the elimination to the expected naphthalene **211i** resulting in a yield of 37%. Interestingly, the byproduct mixture was not mainly composed by the usual non-eliminated amine **213**. Careful 2D-NMR analysis (i.a. HSQC-TOCSY) revealed a complex tricyclic structure **214** (2:2.5 ratio of *endo:exo* isomer of the amine) as the major component (>50% of the aromatic fraction).¹² Such a scaffold can be readily explained by the following rationale: Elimination of N₂ leads to the *o*-quinodimethan type intermediate **213**, which can now undergo a normal Diels-Alder reaction with the olefin moiety.

Scheme 65. Catalyzed IEDDA reaction of citronellal.

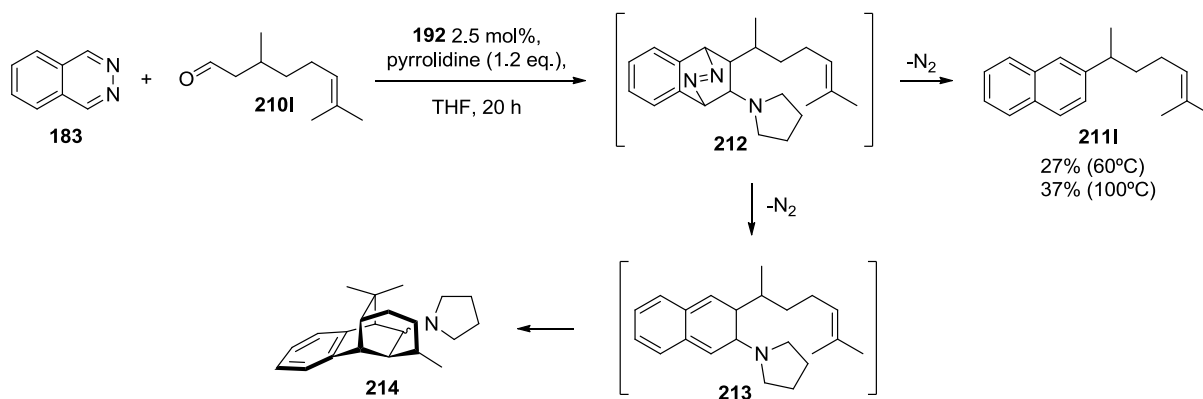

The interesting tricycle **214** is featured in a number of natural products (Figure 18). For instance, valerianoid A-C **215**,^{183,184} constituents of folk medicine for sedative and antispasmodic purposes, as well as patchouli alcohol **216**,^{185–188} used in fragrances, map the complete saturated carbon framework of **214** without the additional aromatic ring.

Figure 18. Natural products as structural analogues of product **214**.

The examples presented above illustrate the utility of the bidentate Lewis acid catalyzed IEDDA reaction to introduce aromatic scaffolds into highly complex and functionalized molecules. Especially hydroxy as well as ester substitution in the substrates do not disturb the reaction and furnish cleanly the desired cycloadducts. Linear aldehydes suffer from side reactions during the enamine-forming step limiting its applicability. Usage of methyl ethylene diamine can partially circumvent this difficulty allowing to access the desired naphthalenes in moderate yield. When citronellal was employed in the catalyzed IEDDA reaction an interesting tricyclic compound was observed besides expected naphthalene derivative. Therefore, this cascade of transformation will offer an efficient access to the complex frameworks, which are found in natural products, as shown above.

3.1.3.4 Substituted 1,2-diazines

In addition to exploring the scope of the dienophiles, different 1,2-diazines were also investigated. Besides the parent phthalazine (**183**), substituted derivatives were screened (Table 5).

Table 5. Substituted 1,2-diazines in the Lewis acid catalyzed IEDDA reaction of phthalazine.

Reaction scheme: 1,2-Diazine (**183**) + Dienophiles $\xrightarrow[\text{temp., time}]{192 \text{ mol\%, diglyme}}$ Product (**217**)

| Entry | 1,2-Diazene | Dienophile | Temp. / time | Product (yield) |
|------------------|-------------|------------|---------------|---|
| 1 | | | 40 °C / 2.5 d | 217a (62%) |
| 2 | | | 100 °C / 24 h | 217ba/217bb (44%, 1.5:1) |
| 3 ^[b] | | | 100 °C / 48 h | 217ba/217bb (61%, 2:1) |
| 4 | | | rt / 48 h | 217c (10%) |
| 5 | | | 140 °C / 24 h | No reaction |
| 6 | | | 80 °C / 2 d | No reaction |

For example, substitution with chlorine in **183a** was found to facilitate the process (Table 5, entry 1). The electron withdrawing properties of chlorine cause a reduction of electron density at the phthalazine moiety, leading to a decreased LUMO energy, which is beneficial for its part as diene in the IEDDA reaction. Surprisingly, groups that are also able to coordinate to the bidentate Lewis acid gave moderate yields of the desired naphthalene derivative. For example, 5-nitrophthalazine (**183b**) can be reacted with different dihydrofurans to furnish the substituted products **217b** and **217c**. It is noteworthy that the reaction can even be performed at room temperature albeit with lower yield (Table 5, Entry 4). In this case the reduction of product formation might be caused by the high tendency of the dienophile to polymerize. Pyridazine, however, did not show any reaction in the bidentate Lewis acid catalyzed IEDDA reaction (Table 5, entry 5). Attachment of an electron withdrawing group (Cl) also did not enable the transformation (Table 5, entry 6), which by calculation of the according complex of methylchloropyridazine **218** and bidentate Lewis acid is obvious (Figure 19). Especially the methyl group allows only a very weak asymmetric coordination due to steric repulsion (B-N bond distances are 3.44 Å and 3.52 Å).

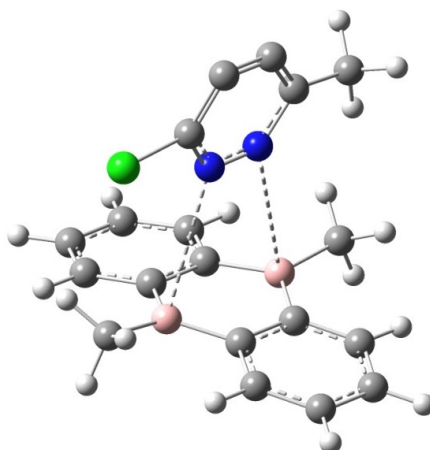

Figure 19. Calculated complex of methylchloropyridazine **218** and bidentate Lewis acid **192**.

The unreactivity of pyridazine **177** can be rationalized by the loss of aromaticity during the initial cycloaddition step. In contrast, when phthalazine is used, the aromaticity is broken in only one of the rings during the course of the reaction what accounts for much less than the full aromatic stabilization energy of pyridazine.

In conclusion, the investigation was set out with the idea of lowering the high LUMO energy of 1,2-diazine by a bidentate complexation of the vicinal nitrogen atoms to being able to undergo a IEDDA reaction with else weakly reactive dienophiles. Eventually, the initial idea was verified with the first IEDDA reaction of oxazolidine **195** and phthalazine **183** with the

most promising bidentate boron based Lewis acid candidate. This Lewis acid **192** was pre-evaluated via computational studies, complexation studies in solution, and acquirement of a solid state structure. Further experimental studies of the scope of dienophiles in this novel catalyzed IEDDA reaction gave insight into its potential. It was now possible to react not only the one or two most active dienophiles (as ranked by Sauer et al.⁵⁸) but also dienophiles ranging from enoethers, enamins derived from ketones as well as from aldehydes to keteneacetals. Furthermore, substituted 1,2-diazines have been shown as well to undergo the bidentate Lewis acid catalyzed IEDDA reaction. As a result, the investigations led to the following listing of reactivity of dienophiles in the catalyzed reaction with phthalazine **183** (Figure 20).

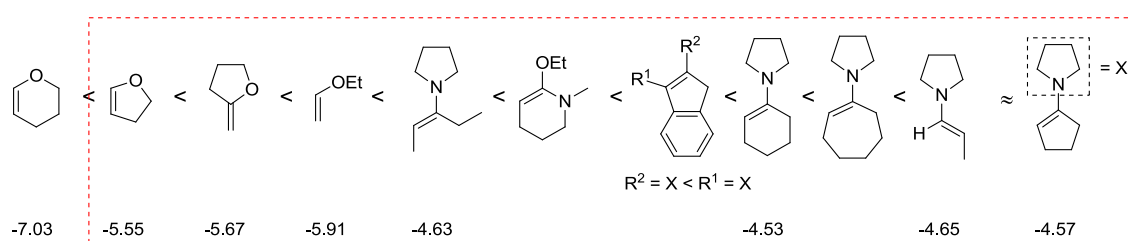

Figure 20. Reactivity order of dienophiles in the bidentate Lewis acid catalyzed IEDDA reaction with phthalazine. Figures indicate HOMO energies in eV.

The calculated HOMO energies correlate fine with the experimental data where the sterical demand is comparable. Hence, where the numbers deviate from the reactivity order the sterical demand makes the difference.

As well it has to be emphasized that the reaction is not promoted in the presence of a monodentate Lewis acid, such as BF_3 . If a monodentate Lewis acid is employed none of the desired cycloadducts could be observed. Instead, all data suggest a nucleophilic addition pathway to the phthalazine, similar to the reported addition of BuLi to phthalazine catalyzed by the monodentate Lewis acid.^[17]

3.1.4 Mechanistic considerations

Consequently, the final proposal of the catalytic cycle (Scheme 66) is as following: (1) The complexation of the bidentate Lewis acid with phthalazine **A** lowers the LUMO of the dienophile (2) allowing the IEDDA reaction to form adduct **D** which (3) eliminates molecular nitrogen to result in the *o*-quinodimethane type intermediate **E** and (4) spontaneous or induced rearomatization leads to the final naphthalene product **F**.

Scheme 66. Proposal of the general catalytic cycle of the IEDDA reaction of dienophiles and phthalazines catalyzed by the bidentate Lewis acid.

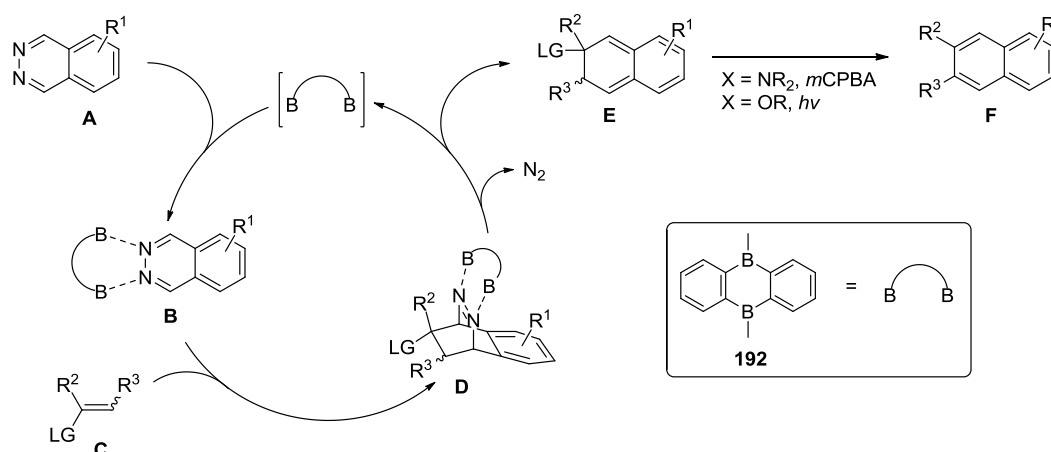

The lowering of the LUMO energy in step (1) is so significant that it decrease from -1.76 to -3.05 eV now ranging in the regime of the very activated 1,4-dicyanophthalazine (-3.42 eV) which even reacts with *N*-methylindole, inert under above conditions.¹⁸⁹ And the ¹H-NMR spectra of the complex showed a severe downfield shift of the protons of the complexed phthalazine moiety as well as the solid state structure showed B-N bonding (1.67 Å) almost as tight as in H₃N-BF₃ (1.60 Å).¹⁹⁰ On the other side, neither a diene nor a dienophile bearing Lewis basic sites did influence the activity of the catalyst.

In step (3) it was shown that some produced intermediates although thermodynamically favored do not proceed to the aromatized product and can sometimes be isolated. So that total elimination to the naphthalene product has to be induced by UV irradiation in the case of enols and by cope elimination with *m*CPBA in the case of enamines.

3.2 One-pot synthesis of phthalazines and pyridazino-aromatics

Above, the versatility of the dienophile substrate scope in the catalyzed IEDDA reaction was shown but the scope of 1,2-diazines was very limited so far. This was mainly due to the unavailability of a general procedure for the direct and convenient access of substituted phthalazines and pyridazino-aromatics.

3.2.1 Introduction

Nitrogen containing heterocycles are of tremendous importance in medicinal as well as material sciences. Phthalazines and pyridazino annulated aromatics represent a special class of compounds. In these materials two nitrogen atoms are placed adjacent to each other resulting in distinct properties. In nature this functional entity has been scarcely found,^{191–193} yet in the last decade diverse bioactivity and medical applications of phthalazines or pyridazino heteroaromatics emerged ranging from bronchodilatory and anti-inflammatory effects,^{194–196} antitumor activity,^{197,198} DNA-intercalation,^{199,200} anticonvulsant activity,²⁰¹ and as a vasorelaxant.²⁰² Also, phthalazine derivatives have been used in material sciences^{203,204} or employed as ligands for a variety of transition metals.^{147,205–210} Some of them are important catalysts,^{211,212} most prominently in the asymmetric dihydroxylation²¹³ of alkenes.

The synthesis of phthalazine derivatives commonly involves multi-step procedures concluding with either ring closing reactions, ring enlargement or aromatization of 1,2-dihydro- or 1,2,4,5-tetrahydrophthalazines.^{214,215,216}

Also reported are inverse electron demand Diels-Alder (IEDDA) reactions of 1,2,4,5-tetrazines **219** with arynes **220**^{217–220}, and arenes **222**²²⁰ or pyridazino[4,5-*d*]pyridazine with enamines^{221,222} as method for the synthesis of phthalazine derivatives **221** and **224** (Scheme 67).

Scheme 67. Phthalazine synthesis via IEDDA reaction from 1,2,4,5-tetrazine.

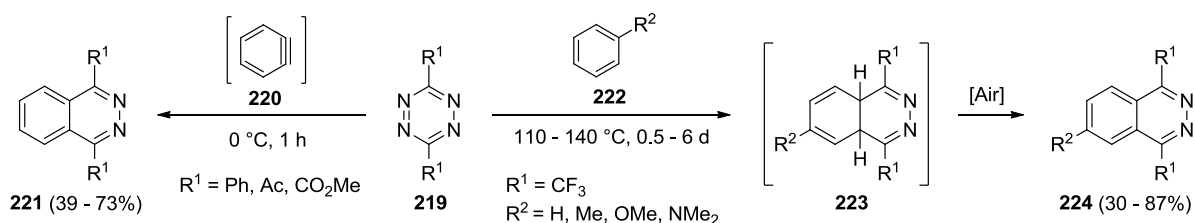

The first synthesis of phthalazine **183** in 1893 by Gabriel and co-workers^{223,224} was done by ring closing reaction of phthalaldehyde **225** or 1,2-bis-dichloromethylbenzene **226** with

hydrazine (Scheme 68). This transformation, the ring closure of *ortho*-dicarbonyls with hydrazine, still comprises the standard route for the preparation of phthalazines.^{225–231}

Scheme 68. First synthesis of phthalazine **183** by Gabriel and co-worker.

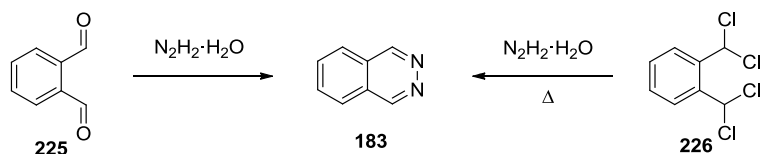

Phthalazines with halogen substituents in 1,4-position are usually synthesized via halogenation of 2,3-dihydrophthalazine-1,4-dione.^{232–235} Both methods, however, are often preceded by many synthetic steps, depending on the degree of substitution in position 5 to 8 of the resulting phthalazine. For example, Tsoungas and co-workers reported such a procedure of six steps starting from 5-methoxy-2-nitrobenzaldehyde via final reaction of the formed dialdehyde **231** with hydrazine to give 6-methoxyphthalazine (**237**) in a overall yield of less than 20% (Scheme 69).²²⁶ Another ring closing reaction is the cyclization of aromatic aldazines, which is conducted in liquid $\text{AlCl}_3/\text{AlBr}_3$, comprising rather harsh conditions.²³⁶

Scheme 69. Synthesis of benzo-substituted phthalazine **237** via an inadequately complex procedure.

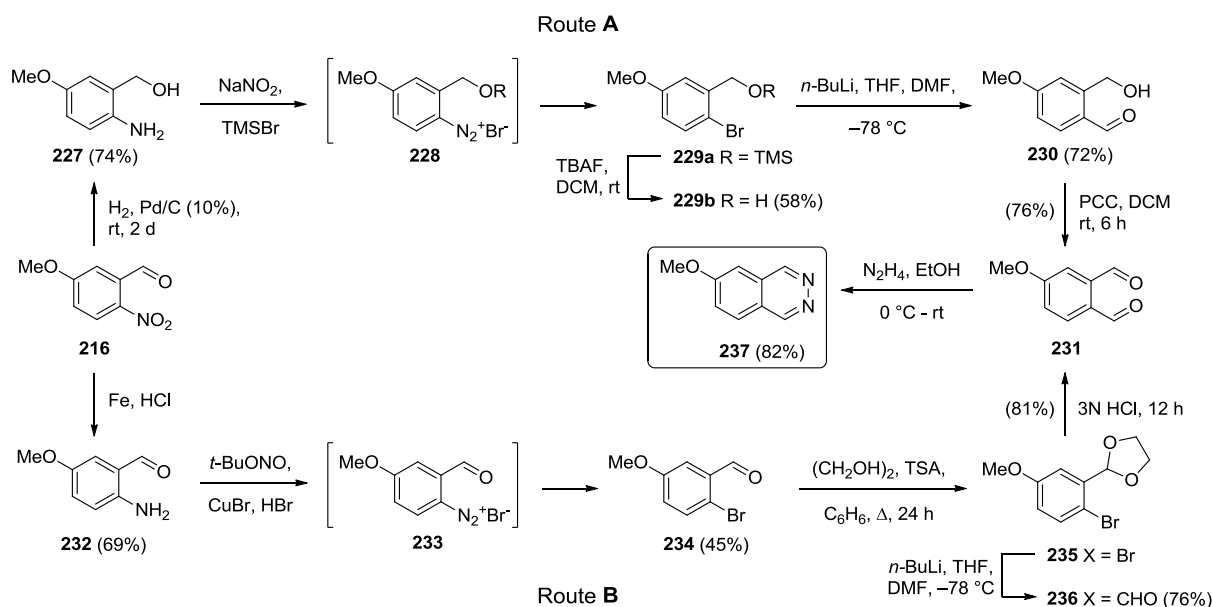

Despite these efforts no approaches of a direct method of a wide range of substituted phthalazines in one pot from simple starting materials are reported to the best of my knowledge. As 1,2-diazines represent a valuable starting material for the aforementioned bidentate Lewis-acid catalyzed IEDDA reaction, it was set out to close this gap in the synthesis portfolio of heterocycles. Herein, a general method is present, by which not only 4-

to 8-substituted phthalazines, but also pyridazino-heteroaromatics are prepared in a one-pot procedure from simple aromatic aldehydes in good to excellent yields.

The key-step of this new method is the transformation of an aromatic aldehyde into a directed *ortho*-metalation group (DMG). Directed *ortho*-lithiation is a very elegant method to form *ortho*-substituted aromatics and has been widely applied (Scheme 70).^{237,238}

Scheme 70. General scheme of *ortho*-lithiation via complexation by a *ortho*-metalation group (DMG).

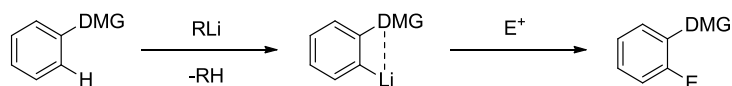

Although an aldehyde **238** is per-se no directing group they it can react with lithium amide LiA to form α -aminoalkoxide **239**, which in turn is a moderate to good DMGs.^{239–243} Based on this principle first applied by Comins and co-workers,^{239,240} a new highly efficient protocol for this strategy was developed (Scheme 71).

Scheme 71. Ortho metalation strategy for a one-pot synthesis of phthalazines

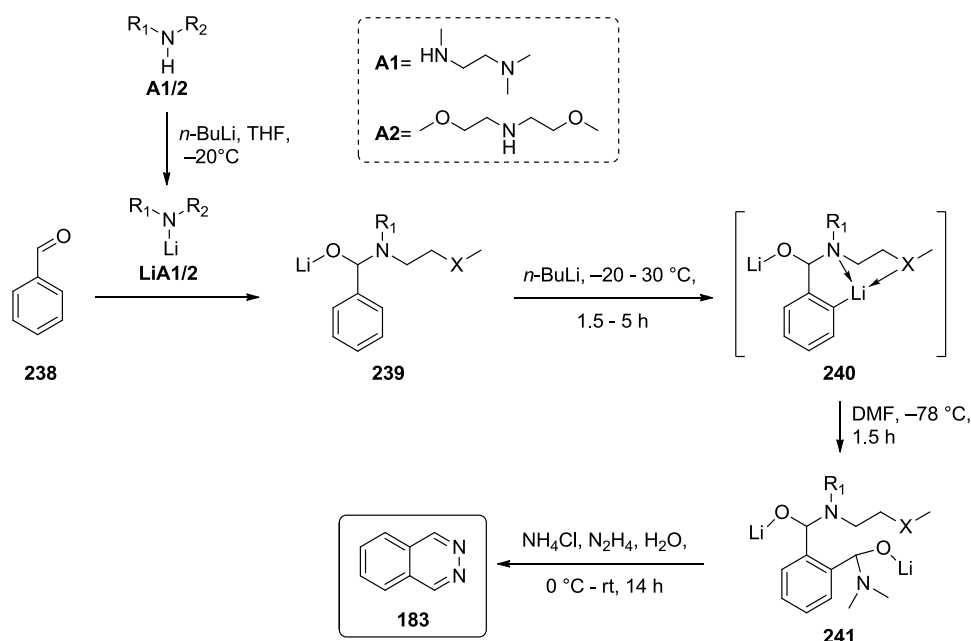

Commonly, the auxiliary *N,N,N'*-trimethylethylenediamine (TMDA) **A1**, is used as lithium amide Li**A1** for the formation of α -aminoalkoxides **239**. Herein, is report for the first time the application of bis(2-methoxyethyl)amine (BMEA) **A2** for this purpose constituting a much cheaper solution as **A1**. The bis(2-methoxyethyl)-amino group itself is a chelating ligand intensively studied in the lithiation of *N,N*-bis(2-methoxyethyl)-2-methylprop-2-en-1-amine (Scheme 72).^{244,245}

Scheme 72. *Ortho*-lithiation of allyl moiety in **242** directed by its bis(2-methoxyethyl)-amino group.

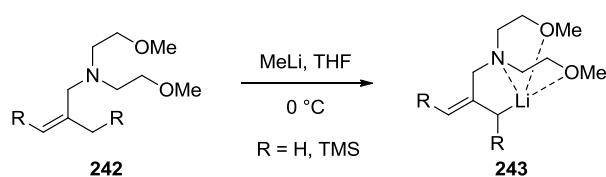

After the in situ formation of the DMG by either LiA1 or LiA2 the dianion **240** is formed via *ortho*-lithiation with *n*-BuLi. Consecutive reaction with dimethylformamide (DMF) gives the *ortho*-bis(aminoalkoxide) **241**. Final hydrolysis with an aqueous solution of ammonium chloride and hydrazine furnishes phthalazine **183** in good yield.

3.2.2 Optimization of reaction conditions

The development of the method involved the optimization of each aforementioned step, mainly the *ortho*-lithiation. Existing protocols for the *ortho*-lithiation of aminoalkoxides were commonly conducted with a large amount of lithiating agent (3 equivalents of *n*-BuLi) and an inconvenient reaction temperature of $-20\text{ }^\circ\text{C}$ over an extended period of 3 h for chlorobenzaldehydes, 24 h for benzaldehyde and up to 48 h for *p*-tolualdehyde.²⁴⁰ The applicability to a one-pot procedure demanded a considerable decrease of reaction time, amounts of *n*-BuLi and enhancement of the efficiency of each elementary transformation. Since *n*-BuLi in pure THF has a half-life time of only 1.78 h at $20\text{ }^\circ\text{C}$ a change of the reaction media was crucial for the optimization.²⁴⁶ Recently, it was shown that already one equivalent of THF in a 1 M solution of *n*-BuLi in cyclohexane at $25\text{ }^\circ\text{C}$ holds similar deoligomerization potential of the lithium organyl as pure THF but only minor decomposition of the THF was observed after 24 h.²⁴⁷ In herein case 3.3 equivalents of THF in an approximately 0.5 M solution of *n*-BuLi in hexane gave the best results. In the THF/hexane solvent mixture it was possible to perform the directed *ortho*-metalation step at room temperature. Simultaneously, the amount of lithiation agent was significantly lower to only 1.5 equivalents of *n*-BuLi. Consequently, significantly shorter reaction times were achieved: 1.5 - 2.5 h at room temperature ($25 - 30\text{ }^\circ\text{C}$) if the auxiliary **A1** and 2 - 5 h at $0\text{ }^\circ\text{C}$ if **A2** was applied

Benzaldehyde **238** was used as test substrate for the optimization. The use of both, the common auxiliary TMDA **A1** and BMEA **A2** allowed the comparison of the performance in the *ortho*-metalation of benzaldehyde (Table 6).

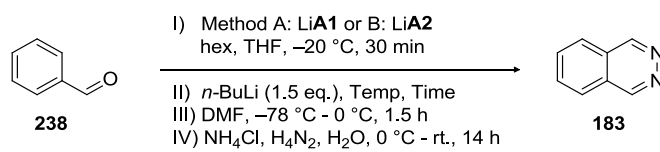
Table 6. Optimization of the *ortho*-lithiation conditions.

| entry | time | Temp. | yield (method) | |
|-------|------|-------|----------------|-----|
| | | | A | B |
| 1 | 2 h | 25 °C | 74% | 35% |
| 2 | 3 h | 10 °C | – | 39% |
| 3 | 4 h | 0 °C | 73% | 56% |
| 4 | 5 h | 0 °C | – | 72% |

Thus, after 4 h of lithiation at 0 °C the one-pot reaction applying TMDA **A1** yielded 73% and BMEA **A2** gave 56% of phthalazine **183**. TMDA **A1** performs slightly better than BMEA **A2**, but in some cases, especially for the more acidic substrates, gives comparable or even better results. It is important to mention, that the yield of phthalazine in the case of BMEA **A2** as the auxiliary augments to 72% after a lithiation time of 5 h at 0 °C. If the *ortho*-lithiation step was conducted at room temperature (25 °C) for 2 h, using TMDA **A1** a yield of 74% was obtained. Using BMEA **A2** the yield decreases substantially to only 35%. Even with an *ortho*-lithiation at 10 °C for 3 h the loss in yield was significant compared with a lithiation temperature of 0 °C. This results concerning BMEA **A2** as the *ortho* directing auxiliary, point towards an accelerated decomposition of the α -aminoalkoxide **231a** at temperatures above 0 °C.

3.2.3 Scope of the one-pot reaction for the synthesis of phthalazines

The optimized protocol on the basis of benzaldehyde **238** was shown to be applicable to a broad range of substituted benzaldehydes producing benzo-substituted phthalazines with good to excellent yields of up to 91% (Table 7). Not only electron withdrawing fluoro, chloro, trifluoromethyl substituents (Table 7, entry 3-7), but also electron donating substituents such as methoxy, methylthio (Table 7, entry 9-11, 14-16) and even dimethylamino groups (Table 7, entry 12) are well tolerated.

Table 7. Synthesis of substituted phthalazines.

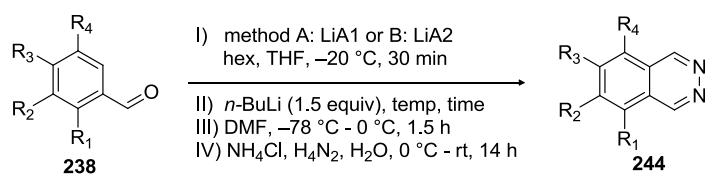

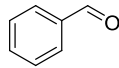
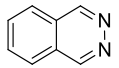
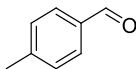
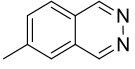
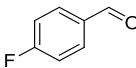
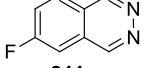
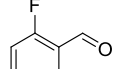
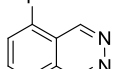
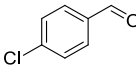
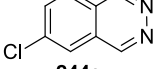
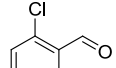
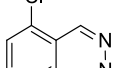
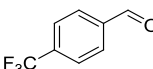
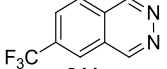
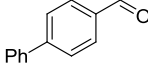
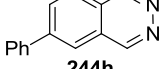
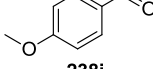
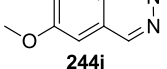
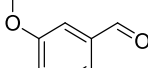
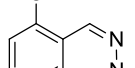
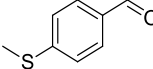
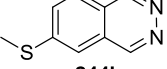
| entry | ArCHO | 1,2-diazine | yield (method) | |
|-------|--|--|----------------|-----|
| | | | A | B |
| 1 |  238a |  244a | 74% | 72% |
| 2 |  238b |  244b | 84% | – |
| 3 |  238c |  244c | 53% | 67% |
| 4 |  238d |  244d | – | 75% |
| 5 |  238e |  244e | 79% | 91% |
| 6 |  238f |  244f | 75% | – |
| 7 |  238g |  244g | 89% | – |
| 8 |  238h |  244h | 80% | – |
| 9 |  238i |  244i | 81% | – |
| 10 |  238j |  244j | 79% | 50% |
| 11 |  238k |  244k | 51% | – |

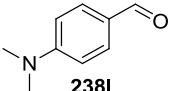
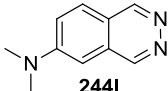
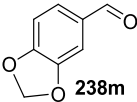
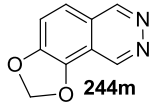
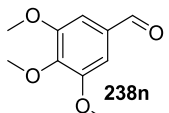
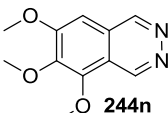
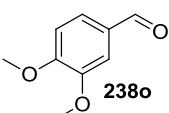
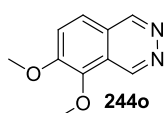
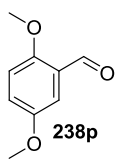
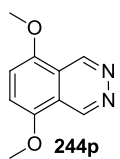
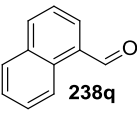
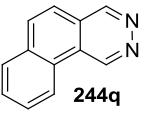
| | | | | |
|----|---|---|-----|---|
| 12 |  |  | 62% | – |
| 13 |  |  | 66% | – |
| 14 |  |  | 61% | – |
| 15 |  |  | 44% | – |
| 16 |  |  | 36% | – |
| 17 |  |  | 68% | – |

Also benzoketons omitting α -protons can be successfully employed in a one-pot reaction resulting in 1-substituted phthalazines, as demonstrated with benzophenone **245** resulting in 1-phenylphthalazine **246** in a 70% yield (Scheme 73).

Scheme 73. Synthesis of 1-substituted phthalazine.

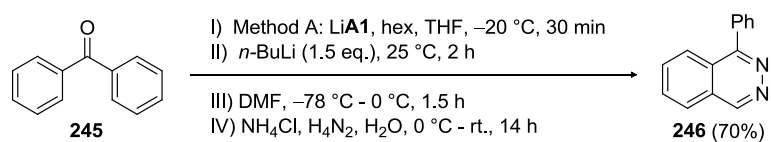

3.2.4 Scope of the one-pot reaction for the synthesis of pyridazino-aromatics

Since pyridine as well as five-membered heteroaromatics are more acidic than benzene derivatives, they require milder lithiation conditions (Table 8).

Table 8. Synthesis of pyridazino-heteroaromatics.

| entry | ArCHO | 1,2-diazine | method | time | Temp | yield |
|-------|-------|-------------|--------|-------|--------|-------|
| 1 | | | A | 2 h | 0 °C | 48% |
| | | | B | 2.5 h | -20 °C | 66% |
| 2 | | | B | 1 h | -20 °C | 81% |
| 3 | | | A | 2 h | 0 °C | 55% |
| | | | B | 2.5 h | -20 °C | 53% |
| 4 | | | A | 2 h | -20 °C | 63% |
| | | | B | 2 h | -20 °C | 50% |
| 5 | | | A | 2 h | 0 °C | 52% |
| | | | B | 2.5 h | -20 °C | 53% |
| 6 | | | B | 1.3 h | -20 °C | 59% |

Hence, lithiation at 0 °C employing BMEA **A2** as auxiliary for the directed *ortho*-lithiation was satisfying. In these cases decreasing the temperature from 0 °C further to -20 °C and shortening of the reaction times compared to benzaldehyde **238a** gave even better results (Table 8), most pronounced in case of thiophene-3-aldehyde **247b** (from 61% to 81%). At similar conditions the auxiliary TMDA **A1** performed slightly better than BMEA though; BMEA in turn presents a much more cost-effective solution (Table 8, Entry 3-5).

3.3 A novel two-step strategy for the synthesis of substituted naphthalenes

As presented above, the bidentate Lewis acid catalyzed IEDDA reaction using phthalazines as electron deficient dienes with a variety of dienophiles, produces 2,3-substituted naphthalenes in a highly efficient way. Joining the herein introduced one-pot synthesis of pyridazinoaromatics with the catalyzed IEDDA reaction concludes an extremely short and very convenient two-step synthesis of, for example, complex, highly substituted naphthalenes (Scheme 74).

Scheme 74. Two-step protocol for the synthesis of substituted naphthalenes.

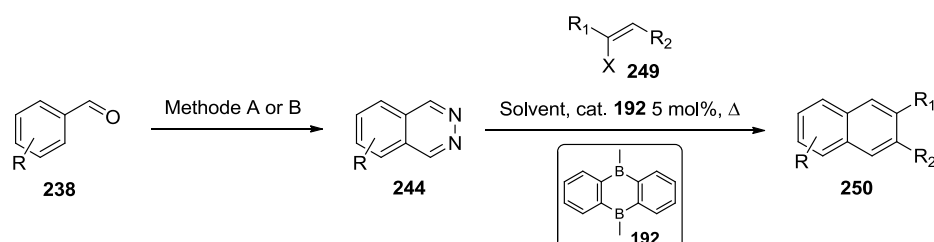

3.3.1 Application for the synthesis of Naproxen

In order to put this powerful approach into context a prominent naphthalene candidate, (±)-Naproxen **250a** has been chosen to demonstrate the utility of the methodology. (±)-Naproxen **250a**, one of the most common non-steroidal anti-inflammatory drugs,²⁴⁸ can be accessed in one-pot from the according diazine **244i** and aldehyde **249a** with a yield of 53% after basic work-up (Scheme 75).

Scheme 75. Preparation of Naproxen in two consecutive steps via one-pot phthalazine synthesis and bidentate Lewis acid catalyzed IEDDA reaction.

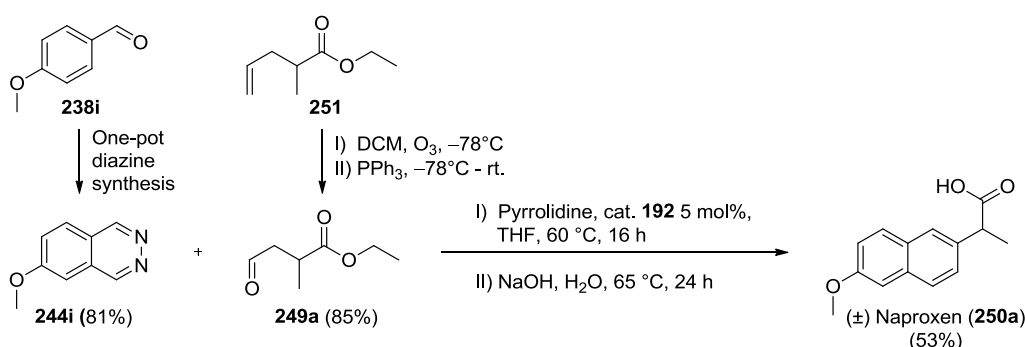

Interestingly, the desired 2,6-substitution pattern (compared to the 1,7-isomer) is obtained in a selectivity greater 9:1 (by ¹H-NMR). Such an outcome is in accordance with the FMO theory, which rationalizes the result based on the analysis of the orbital coefficients of the participating HOMO and the LUMO.

3.3.2 Application for the synthesis of silylnaphthalenes

By the synthesis of more electron poor phthalazine such as chloro and fluoro naphthalenes it was possible to further broaden the scope of dienophiles to the least reactive ones described by Sauer and co-workers.⁵⁸

Bis-TMS aromatics are attractive intermediates not only for the synthesis of the herein described catalyst **192** but also for example the boron-doped polymers^{150,162} or the preparation of benzyne precursors²⁴⁹ (Scheme 76).²⁵⁰

Scheme 76. Preparation of bis-TMS naphthalenes; valuable intermediates for various applications.

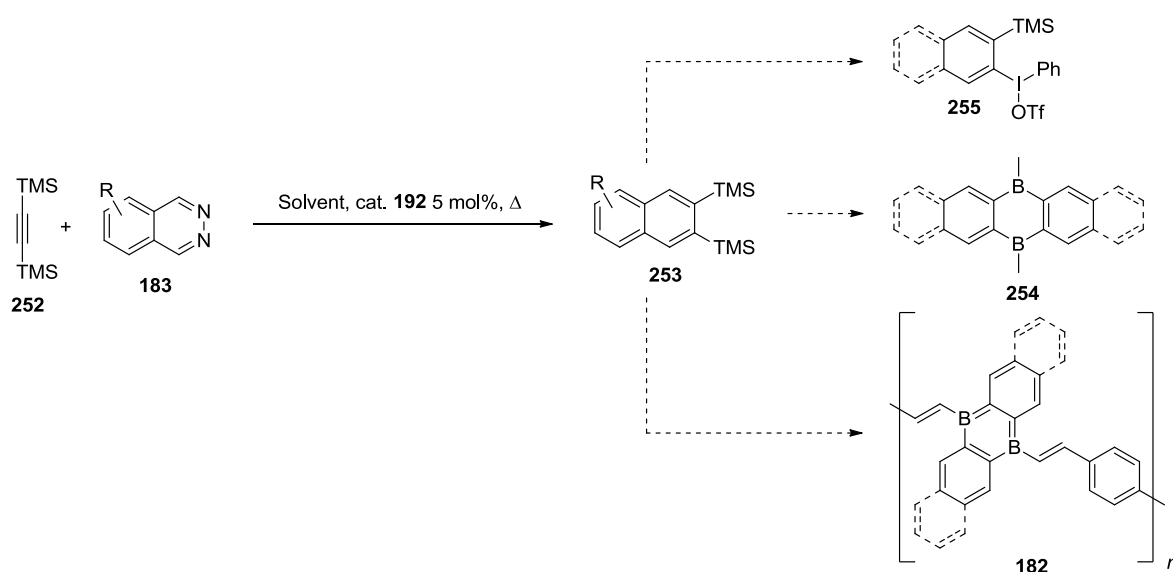

Additionally, DFT calculations of complex of phthalazine **183** and dimethyldibenzodihydroboranthrene **254** have revealed that this type of bidentate Lewis acids are even more potent than dihydroboranthrene **192** (Figure 21).

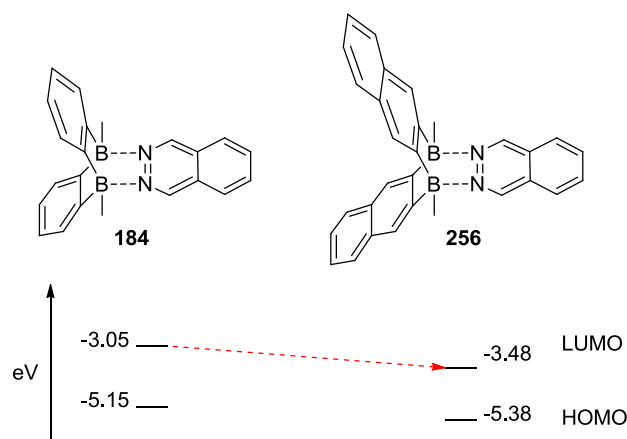
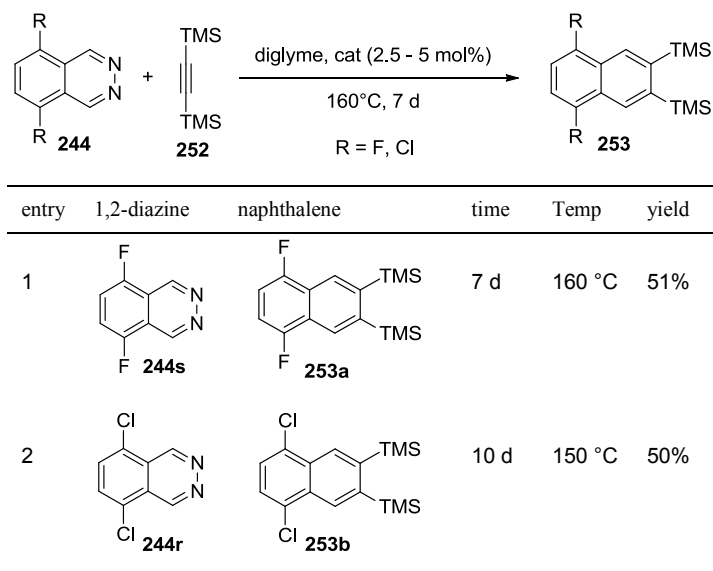

Figure 21. Additional lowering of computed LUMO energies of phthalazine/dimethyldibenzodihydroboranthrene complex

The synthesis of bis-TMS naphthalenes via catalyzed IEDDA reaction was carried out with bis TMS acetylene **252** and the two most reactive substituted phthalazines **253r** and **253s** (Table 9).

Table 9. Synthesis of bis-TMS naphthalenes via catalyzed IEDDA reaction.



The naphthalenes have been obtained in mediocre yields reflecting pre-optimized conditions, where the reaction was terminated although it was still ongoing. This shows the stability of the catalyst even at elevated temperatures.

3.4 Catalyzed domino IEDDA/cyclopropanation reaction of diazines

Nowadays, the efficient use of resources, as well as the minimization of waste and production costs is more important than ever. Therefore, an organic synthesis procedure where one could form several bonds in one sequence would lead to a tremendous benefit over usual stepwise procedures. Domino reactions represent a highly potential approach to address the above mentioned criteria.^{251,252} Especially the incorporation of Diels-Alder reactions into Domino sequences allows to quickly access molecular complexity.²⁵³ The inverse electron-demand Diels-Alder (IEDDA) reaction emerged in the last decades^{66,254} as powerful synthetic tool featured in the preparation of complex molecules.^{255–260,261} As presented above, the first catalytic activation of 1,2-diazines by a bidentate Lewis acid for an IEDDA reaction with a broad application spectrum was shown.

3.4.1 Introduction

During the investigations of electron rich furan **257a** in the catalytic IEDDA reaction a novel bidentate Lewis acid catalyzed domino IEDDA/cyclopropanation reaction was discovered (Scheme 77).

Scheme 77. Reaction path of the catalyzed domino IEDDA/cyclopropanation reaction of an electron rich furan and a diazine.

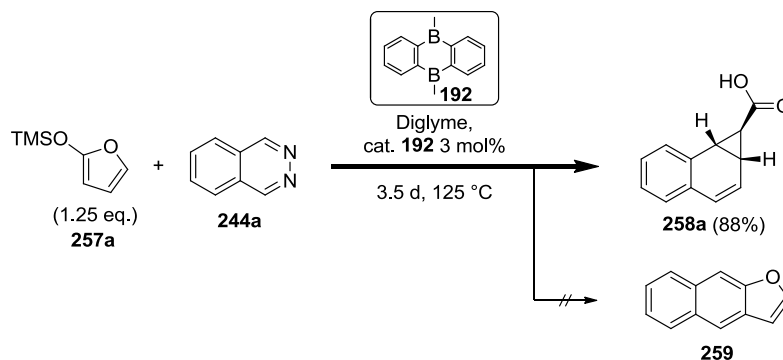

The application of these dienophiles did not yield the anticipated annelated ring system **259**. Instead the cycloaddition intermediate was further transformed to the cyclopropane annelated benzenorcaradiene **258a**. In Nature the benzenorcaradiene framework is for instance found in salvipuberulin **260** (Figure 22).^{262,263}

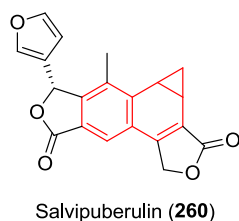
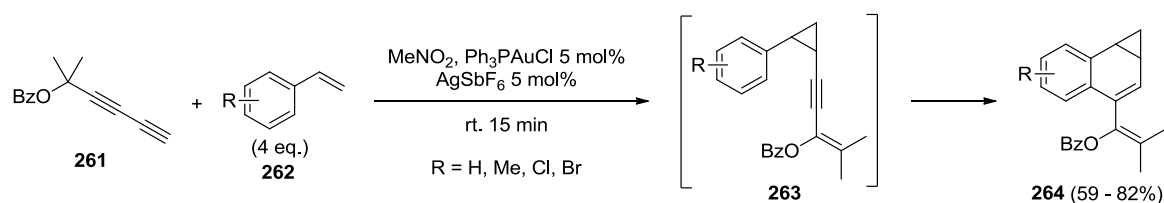

Figure 22. Salvipuberulin constitutes of a benzenorcaradiene framework.

Additionally, such highly functionalized compounds containing small rings are useful building blocks for further transformations, to quickly access complex target structures, especially in the context of new drugs. Lately, three different methods have been published forming benzenorcaradiene with either no or limited range of aromatic substituents.

Toste and co-workers published a gold(I)-catalyzed tandem cyclopropanation/hydroarylation reaction producing formal [4+3] annulation products from vinyl arenes and propargyl esters (Scheme 78).²⁶⁴

Scheme 78. Tandem cyclopropanation/hydroarylation reaction to produce benzenorcaradienes.



Very recently, Tenaglia et al. presented a ruthenium-catalyzed coupling of oxabenzonorbornadienes and propargyl alcohols to obtain benzenorcaradienes (Scheme 79).²⁶⁵

Scheme 79. Ruthenium-catalyzed coupling reaction to obtain benzenorcaradienes.

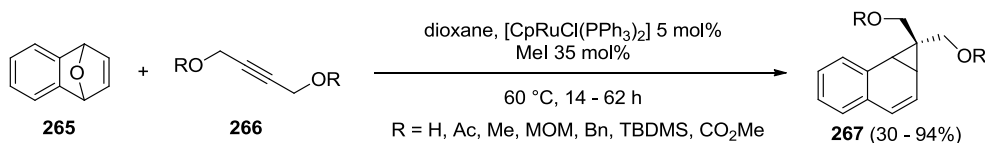

The third synthesis proceeds by a DA reaction of an *o*-quinodimethan tungsten complex and methoxyfuran. The tungsten complex is prepared from ethynylphenylketone and three equivalents of $W(CO)_5 \cdot THF$.^{266,267}

Scheme 80. Benzonorcaradiene synthesis by two steps from ethynylphenylketone **268** via *o*-quinodimethan tungsten complex.

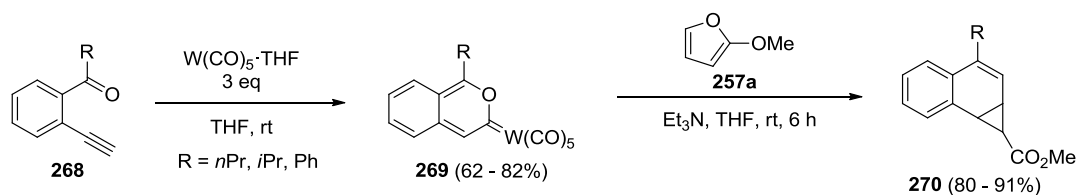

3.4.2 Scope of the catalyzed domino IEDDA/cyclopropanation reaction

The investigations started with the reaction of phthalazine and differently substituted oxyfurans **257a-e**, to display the scope of dienophiles in the Lewis acid catalyzed domino reaction (Table 10).

Table 10. Scope of dienophiles in the domino IEDDA/cyclopropanation reaction.

| entry | 257 | 244 R ⁴ R ⁵ | product | t | T | yield |
|-------|------------|---|---------|-------|--------|-------|
| 1 | | H H | | 3.5 d | 125 °C | 88% |
| 2 | | H H | | 4 d | 140 °C | 80% |
| 3 | | H H | | 2.5 d | 155 °C | 99% |
| 4 | | H H | | 1.5 d | 115 °C | 90% |
| 5 | | Cl Cl | | 1.5 d | 115 °C | 90% |

Thereby, all substrates did not show any reaction in the absence of catalyst even if heated to 160 °C for one day. Both steric as well as electronic factors play an important role in the reactivity of oxyfurans. The most reactive oxy-substituent is the trimethylsilyl (TMS) moiety due to polar effects followed by the methyl substituent and the least reactive, the triisopropylsilyl (TIPS)-group due to steric reasons (Table 10, entry 1-3). Oxyfuran **257a** directly yielded the free acid **258a** after purification on silica gel (SiO₂), while **257b** and **257c** gave access to stable esters **258b** and **258c**. The methyl substituent on the furan core accounts for another positive inductive effect while also adding steric bulk, which counteract depending on the position of the Me group. A methyl-substituent in 3-position as in **257d** is beneficial for the reaction allowing to run the reaction at lower temperature in a shorter time compared to the unsubstituted analog **257a** (Table 10, entry 4). If the methyl substituent is placed in position 5 it seems to sterically interfere with the reactive site resulting in permitting the reaction only with the more reactive dichlorophthalazine **244r** (Table 10, entry 5). No reaction was observed with less electron deficient phthalazine **244a**. This sterical interference can be explained by the repulsive sterical interaction of the methyl residue in furan **257e** with the Lewis acid **192** in complex **184**¹⁷⁶ during the IEDDA reaction (Figure 23).

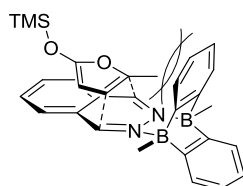
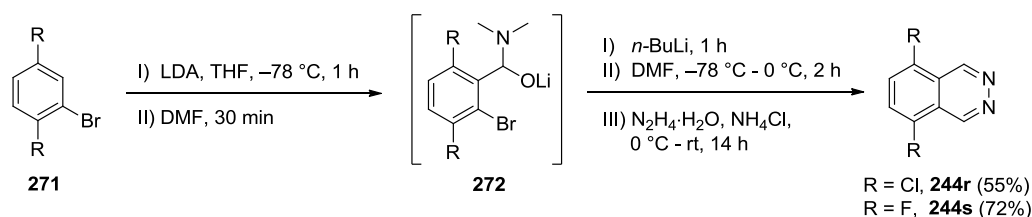

Figure 23. Steric interaction of methyl group in **257e** with Lewis acid moiety of complex **184**.

To demonstrate the scope of dienes, a variety of differently substituted diazines and trimethylsilyloxyfuran **257a** have been employed in the Lewis acid catalyzed domino IEDDA/cyclopropanation reaction (Table 11). The substituted diazines can be accessed by an one-pot synthesis from aldehydes, as mentioned above. Moreover, alkyl lithium chemistry was used to form dichloro- and difluorophthalazine **244r** and **244s**, also in one-pot in good yields (Scheme 81).

Scheme 81. Dihalogeno phthalazine synthesis via *ortho*-lithiation and Br/Li exchange.



Results and Discussion

Table 11. Scope of dienes in the domino IEDDA/cyclopropanation reaction.

Reaction scheme showing the domino IEDDA/cyclopropanation reaction of diene **257a** (TMSO-substituted) with a diazine derivative (R², X) in Diglyme, catalyzed by **192** (2-5 mol%), SiO₂, and conditions T, t. The reaction yields a bicyclic product **258** (R¹ = TMS or H).

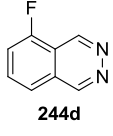
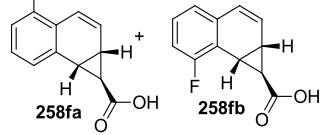
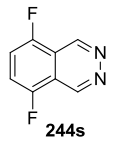
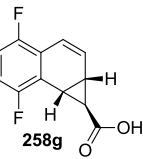
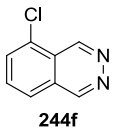
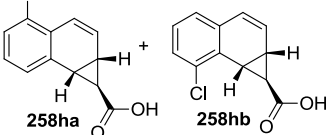
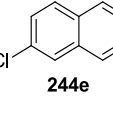
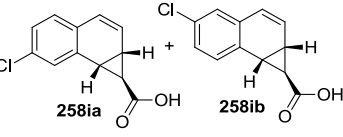
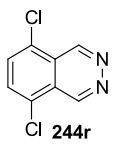
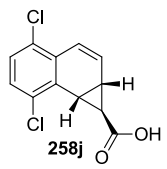
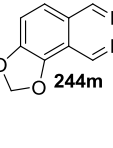
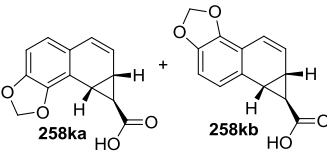
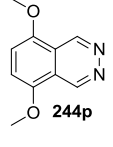
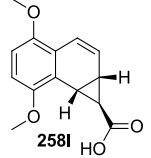
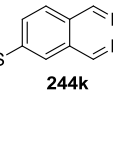
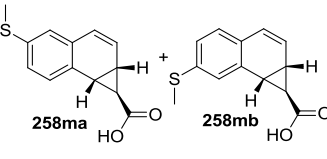
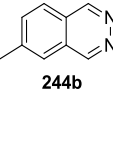
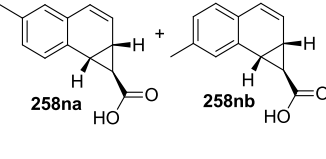
| entry | diazine | products | t | T | yield (a:b) |
|-------|--|--|-------|--------|----------------|
| 1 |  244d |  258fa + 258fb | 1 d | 105 °C | 88% (1:1:1) |
| 2 |  244s |  258g | 14 h | 95 °C | quant. |
| 3 |  244f |  258ha + 258hb | 1 d | 130 °C | quant. (1:1:1) |
| 4 |  244e |  258ia + 258ib | 4 d | 120 °C | quant. (1:1:3) |
| 5 |  244r |  258j | 1.5 d | 80 °C | 98% |
| 6 |  244m |  258ka + 258kb | 3 d | 120 °C | 78% (1:1.5) |
| 7 |  244p |  258l | 11 d | 160 °C | 93% |
| 8 |  244k |  258ma + 258mb | 3.5 d | 145 °C | 95% (1.2:1) |
| 9 |  244b |  258na + 258nb | 3.5 d | 150 °C | 92% (1:1) |

Results and Discussion

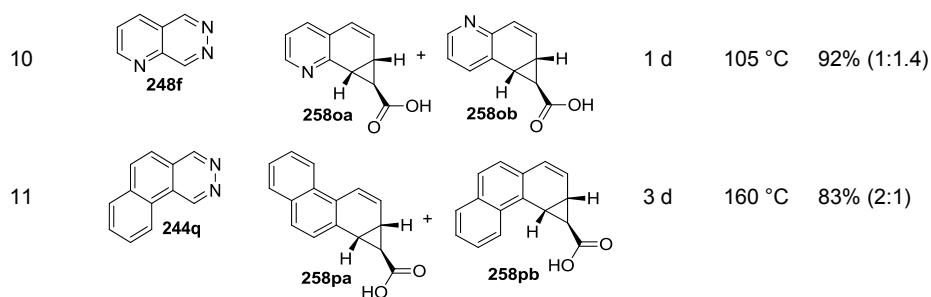

Since in an IEDDA reaction an electron deficient diene is preferred over an electron rich one, the reactivity of substituted phthalazines decreases in the following order of substituents: F>Cl>MeS≈Me>MeO (Table 11).

Table 12. Domino IEDDA/cyclopropanation reaction forming isolable esters.

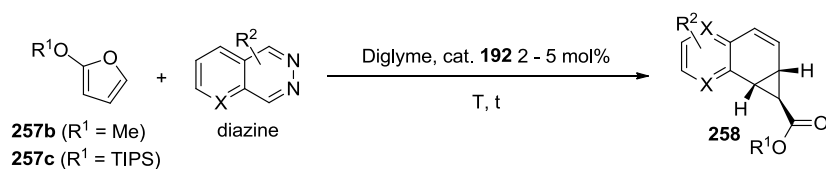

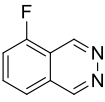
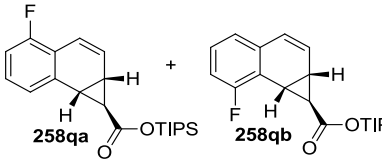
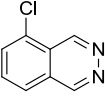
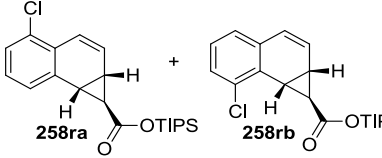
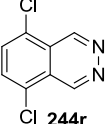
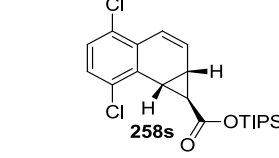
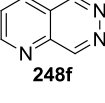
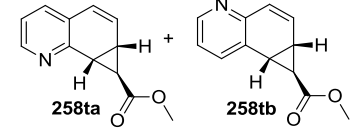
| entry | diazine | product | t | T | yield (a:b) |
|-------|--|--|-------|--------|-------------|
| 1 |  244d |  258qa 258qb | 1 d | 130 °C | 96% (1.3:1) |
| 2 |  244f |  258ra 258rb | 1 d | 135 °C | 99% (1.1:1) |
| 3 |  244r |  258s | 1 d | 90 °C | 91% |
| 4 |  248f |  258ta 258tb | 0.5 d | 120 °C | 91% (1:1.1) |

Therefore, the reaction temperature can be lowered to 80 °C in the case of dichlorophthalazine **244s** and had to be risen to 160 °C with a prolonged duration in the case of dimethoxyphthalazine **244p**. Even pyridopyridazine **248f** and benzophthalazine **244q** showed to be reactive in this transformation. The complete desilylation of the labile trimethylsilyl ester was accomplished by slightly acidic elution on silica forming the carboxylic acid.

Furthermore, other TIPS-ester **258q** - **258s** have been synthesized, showing the good applicability of **257c** in the reaction of electron poor phthalazine **244d**, **244f** and **244r** (Table 12, entry 1-3). The reaction of methoxyfuran **257b** with pyridopyridazine **248f** gave the methylester **258t** (Table 12, entry 4). These additional examples demonstrate not only the high atom economy merely producing N₂ as a side product but also the versatility of the procedure.

In cases of non-symmetrical phthalazine substrates the IEDDA/cyclopropanation reaction produces mostly regioisomers of both DA adduct in similar amounts (Table 11 and Table 12). Substitution in 5 – 8 position on the phthalazine hardly influences the ratio of the regioisomers.

3.4.3 Mechanistic considerations

The proposed catalytic cycle as shown in Scheme 66 derived from Heuschmann and co-workers^{85,138–140} starts with the complexation of phthalazine **244a** by the bidentate Lewis acid **192** to activate the diazine for the following IEDDA reaction. The cycloaddition of complex **184** with methoxyfuran **257b** gives intermediary complex **273**. The elimination of molecular nitrogen regenerates the Lewis acid catalyst **192** and the proposed dihydronaphthalene intermediate **274** is formed. Intermediate **274** rearranges to *endo*-cyclopropane **258b'** and *endo*-to-*exo* isomerization^{268–270} leads to the final product **258b** (Scheme 82).

Scheme 82 Proposed catalytic cycle of the IEDDA/cyclopropanation reaction.

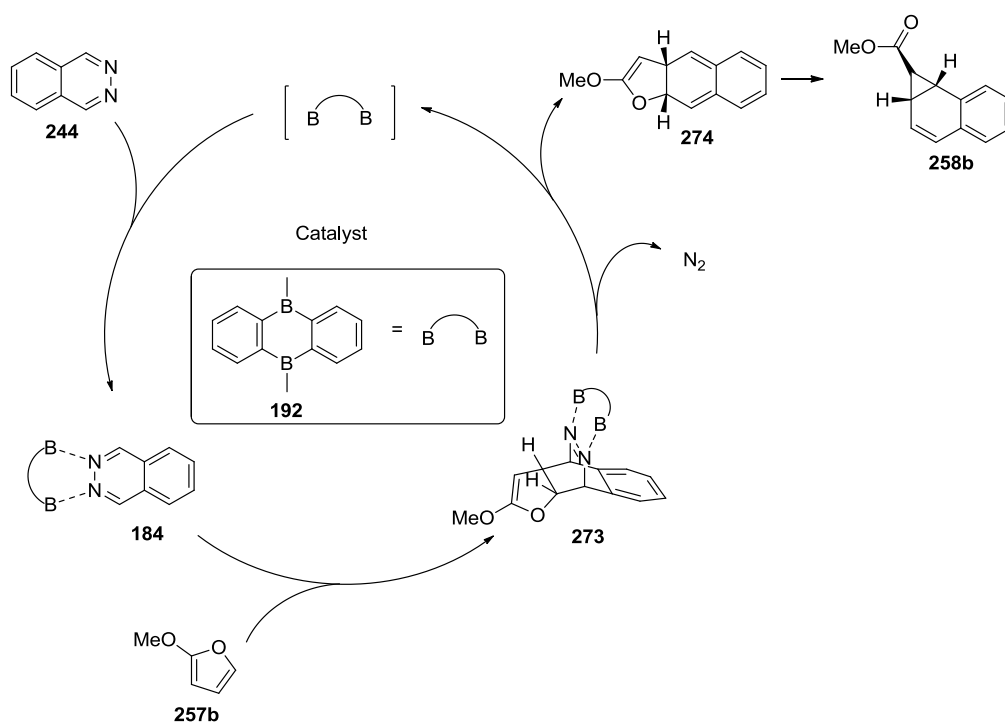

By the nature of the IEDDA cycloaddition the domino reaction is diastereoselective resulting in only the *exo*-cyclopropane proven by 2D-NMR as well as x-ray analysis (Figure 24).

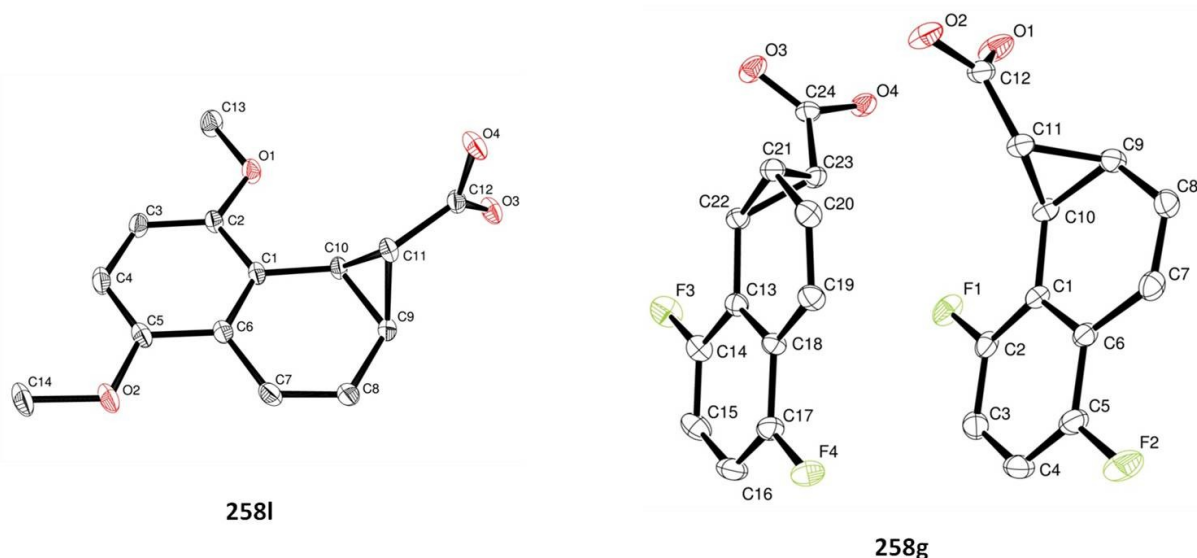

Figure 24. Solid state structures of dimethoxyphthalazine **258i** and difluorophthalazine **258g**.

The intermediary formed dihydronaphthalene **274** represents an *o*-quinodimethane-type, which are well known highly reactive intermediates.^{271–275} As shown above, it was possible to trap such a *o*-quinodimethane intermediate by an intramolecular Diels-Alder reaction consecutive to the Lewis acid catalyzed IEDDA reaction (Scheme 65). Stable *o*-quinodimethanes have been unambiguously characterized and expose substantial double bond with some biradical character indicated by calculations (Figure 25).^{276,277}

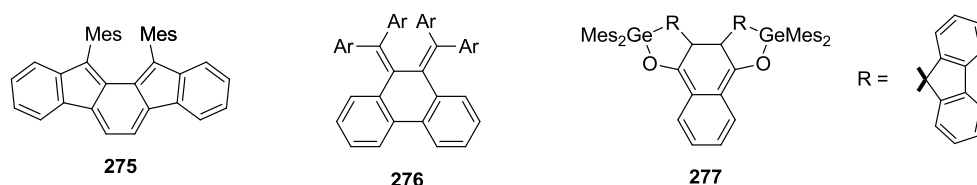
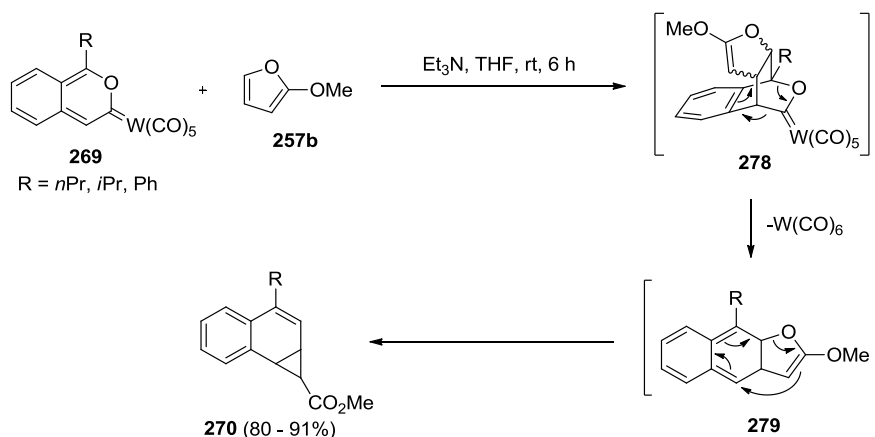

Figure 25. Isolable *o*-quinodimethan derivatives.

Dihydronaphthalene **274** reacting as tetraene-species undergoes the final rearrangement to form the cyclopropanaphthalene **258b**. The same observations were made starting from a tungsten-tetraenecomplex (Scheme 80).^{266,267} In detail, Iwasawa et al. describe the mechanism as following: (1) DA reaction of tungsten complex **269** and furan **257b** gives intermediate **278**, which, by elimination of $W(CO)_6$ forms the *o*-quinodimethan type intermediate **279**, almost identical with **274**, that undergoes a “intramolecular nucleophilic attack” to form cyclopropane **270** (Scheme 83).²⁶⁷ However, nothing more was mentioned about the mechanism of this “intramolecular nucleophilic attack”.

Scheme 83. Reproduced mechanism from Iwasawa et al.²⁶⁷

From dihydronaphthalene **274** the occurrence of a sigmatropic rearrangement according to the Woodward-Hoffmann rules was proposed.^{278,279} A σ -bond is moved from position 1 to 3 on one site and from 1' to 9' on the other side (Scheme 84). The simplified 3-atom and 9-atom fragments can be divided into their topologies. On the 3-atom fragment the migration of the σ -bond occurs on the opposite face and on the 9-membered fragment on the same leading to an 'allowed' antarafacial [3,9]-sigmatropic rearrangement involving $4n$ ($n = 3$) electrons. Alternatively, the transformation can be described by the model according to Dewar⁴⁰ and Zimmerman.⁴¹ This way one phase dislocation occurs, representing a Möbius topology which in the case of $4n$ electrons describes an 'allowed' transition state.

Scheme 84. Proposed [3,9]-sigmatropic rearrangement.

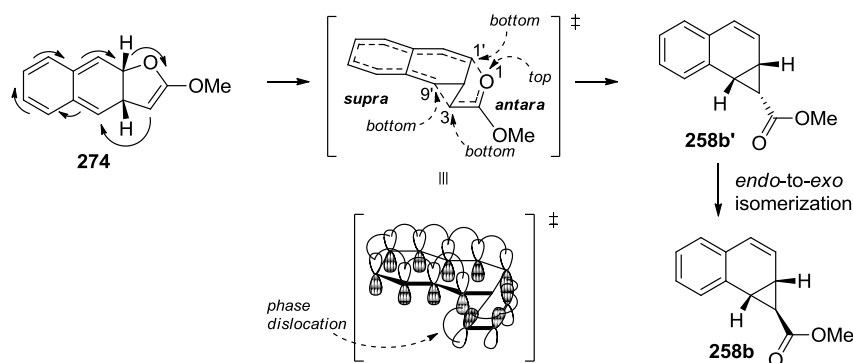

The antarafacial [3,9]-sigmatropic rearrangement of furan **274** to cyclopropane **258b'** is supported via DFT calculations on B3LYP level with a basis set of 6-31g(d,p). Since, furan **274** occurs in two conformers distinguished by the position of the methoxy group which are very close in energy (Scheme 85).

Scheme 85. Different conformers of furan **274** by the rotation of the methoxy group. Gibbs free energy difference in brackets.

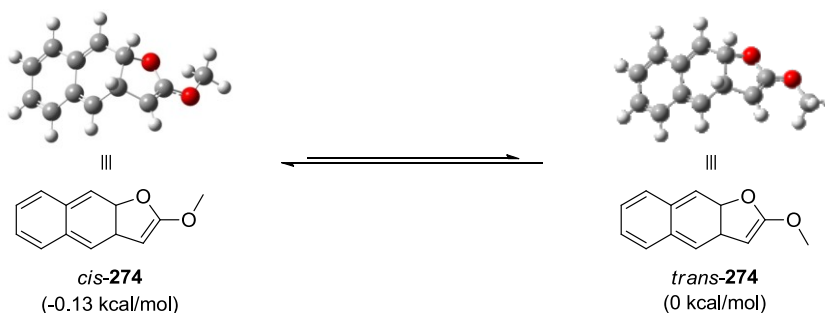

The transition state of both conformers have been located in the gas phase resulting in two energetically different pathways. The “*cis*-furan” lead to an activation energy as low as $\Delta^\ddagger G^\circ_{(T=298)} = 9.3$ kcal/mol and to a high Gibbs free energy of reaction $\Delta_r G^\circ_{(T=298)} = -39.1$. In turn, “*trans*-furan” leads to a slightly more congested transition state resulting in a higher free energy of activation of $\Delta^\ddagger G^\circ_{(T=298)} = 11.9$ kcal/mol and the next local minima (*trans*-ester) is reached at Gibbs free energy of reaction $\Delta_r G^\circ_{(T=298)} = 30.3$ kcal/mol (Figure 26). The high thermodynamic driving force of the rearrangement results from the formation of the ester resonance and the aromatic stabilization which has been lost in the dihydronaphthalene intermediate **274** by the elimination of molecular nitrogen springloading the molecule and easily accounting for the strain energy of the cyclopropane formation. Despite the evidence for a rearrangement an ionic mechanism cannot be ruled out.

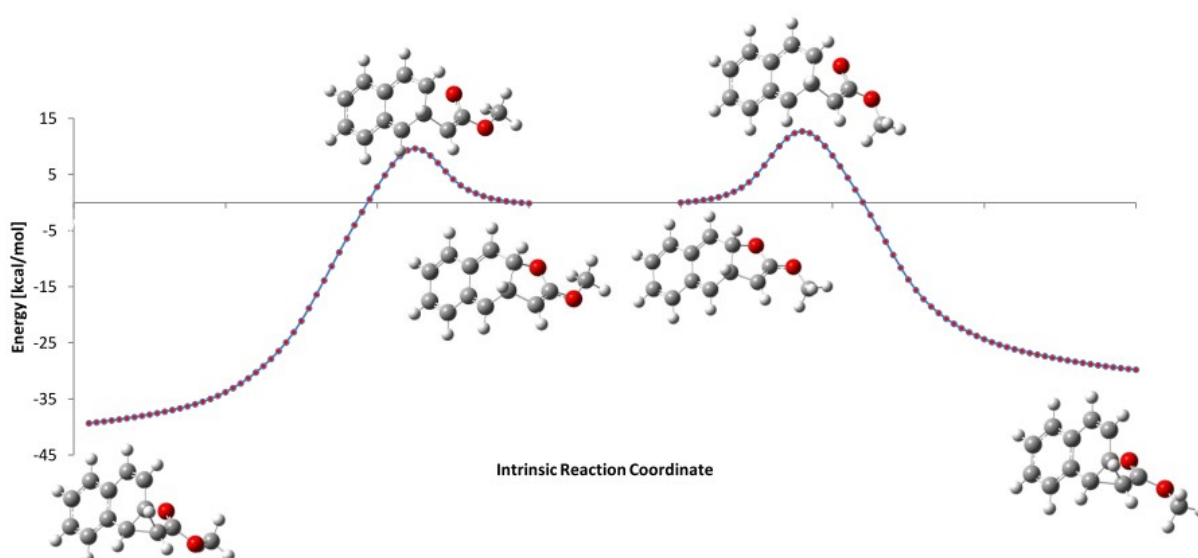
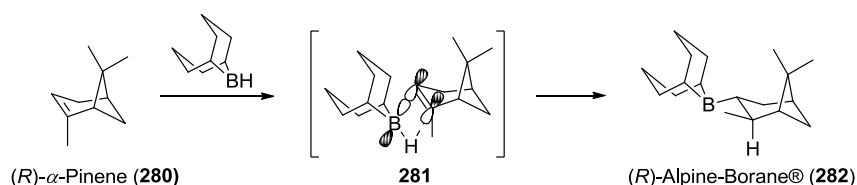

Figure 26. Intrinsic reaction coordinates of the sigmatropic rearrangement. To the left, reaction path to the *cis*-ester and right, to the *trans*-ester.

3.4.4 Enantioselective catalysis in the IEDDA/[9,3]-sigmatropic rearrangement

One of the most elementary way to obtain organoboranes is the hydroboration reaction as intensively investigated by H.C. Brown and co-workers.^{280,281} The reaction involves the addition of borane to the alkene or alkyne in an anti-Markovnikov fashion. This method is as well used to obtain chiral boron compounds, such as alpine-borane prepared from naturally occurring monoterpene pinene (Scheme 86).

Scheme 86. Hydroboration reaction of α -pinene and borabicyclononane.



Alpine-borane is widely used for the asymmetric reduction of ketones, also called the Midland reduction²⁸², recently featured in the total synthesis of (-)-galanthamine (Scheme 87).²⁸³

Scheme 87. The Midland Alpine-borane reduction in the total synthesis of (-)-galanthamine.

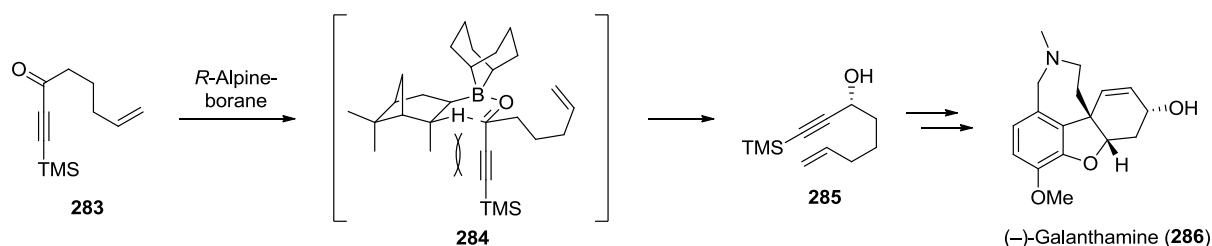

Herein the above described methods have been adapted to acquire direct access to chiral catalysts via hydroboration with commercially available terpenes. Dihydroboranthrene **287** was synthesized by the reaction of the dichloroboranthrene **188** with Et_3SiH in DCE.¹⁵⁰ The so obtained dihydroboranthrene **287** can react with unsaturated alkanes via hydroboration.

Scheme 88. Synthesis of dihydroboranthrene via dichloro dihydroboranthrene.

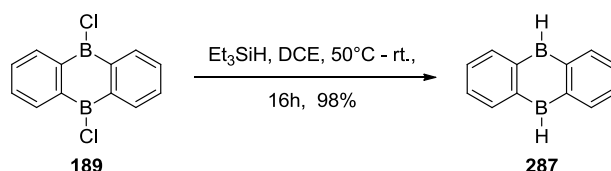

Four different monoterpenes have been tested as additives with dihydroboranthrene to form the chiral catalyst in situ (Figure 27).

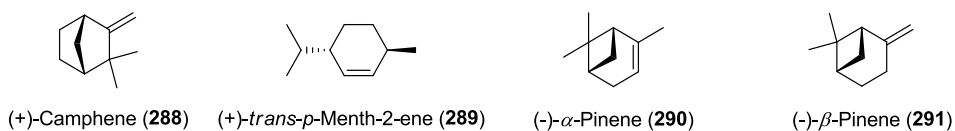
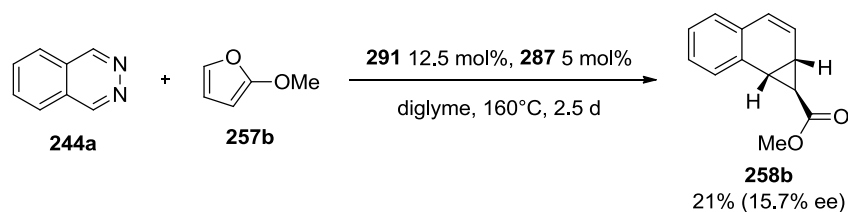

Figure 27. Monoterpenes for the in situ formation of chiral catalyst via hydroboration.

Except for α -pinene **290** all reactions with additives showed turnover. Although the highest turnover was achieved by using β -pinene in the reaction of phthalazine **244a** and methoxyfuran **257b**, the yield is modest (Scheme 89).

Scheme 89. Enantioselective catalyzed IEDDA/cyclopropanation reaction.



The enantiomeric excess (ee) of the reaction was found to be 15.7%. The small ee could be explained by the little sterical distinction of the sites of the double bond, where on one side there is a hydrogen atom and on the other side a lone pair (Figure 28).

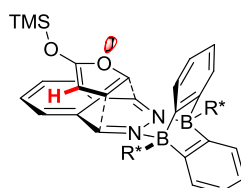

Figure 28. Sterical distinction of the sites of the reacting furan double bond.

Even though the yield together with the ee is low, it shows a potential approach for a chiral catalyst in the IEDDA/cyclopropanation reaction.

3.5 Catalyzed domino IEDDA/[1,9]-sigmatropic rearrangement of diazines

In a different experiment, the pathway of the reaction was investigated when no rearomatization can occur. By the use of an alkyl furan **292** in the catalyzed IEDDA reaction with phthalazine **244a** the reaction was expected to lead to the *o*-quinodimethane intermediate **293** as in the proposed catalytic cycle for electron rich furans (Scheme 82). But from then on, none of the above encountered reaction pathways are credible. Whether elimination nor a [3,9]-sigmatropic rearrangement can occur (Scheme 90).

Scheme 90. Cycloaddition of dienophile without the credible possibility of rearomatization.

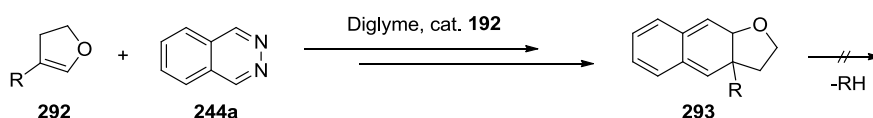

Alkyl dihydrofuran **292** was synthesized from lactone **294** in two consecutive steps by reduction with DIBAL-H and elimination with MsCl (Scheme 91).

Scheme 91. Two step reduction elimination procedure to synthesize 4-substituted dihydrofuran.

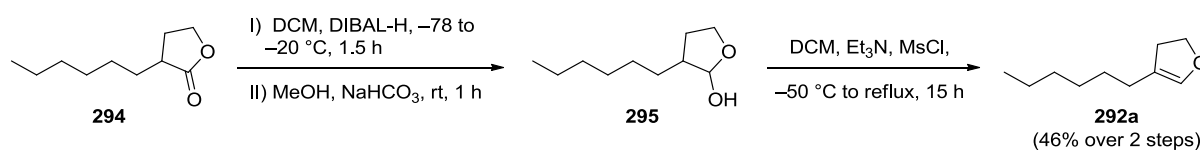

The final catalyzed IEDDA reaction of dihydrofuran **292a** and phthalazine **244a** resulted in tetrahydrofuran **296a**, a new type of products (Scheme 92). The structure was verified via 2D-NMR. The rather low yield of the reaction can be attributed to pre-optimized reaction conditions.

Scheme 92. Catalyzed IEDDA reaction of 4-substituted dihydrofuran and phthalazine.

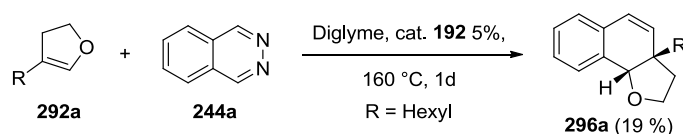

A similar dihydrofuran **297a** was derived from **292a** by deprotonation and reaction with disulfane (Scheme 93).

Scheme 93. Sulfurylation of dihydrofuran **292a**.

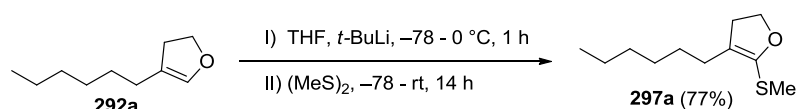

The following IEDDA reaction of methylthiodihydrofuran **297a** with phthalazine at 160 °C showed no turnover after one day. But employing the much more reactive difluorophthalazine

244s in the catalyzed cycloaddition reaction at 125 °C smoothly proceeded to the tetrahydrofuran **298** with a yield of 95% (Scheme 94). Also in this case, 2D-NMR techniques have been used to confirm the structure.

Scheme 94. Catalyzed IEDDA reaction of 5-methylthiodihydrofuran **297a** with difluorophthalazine.

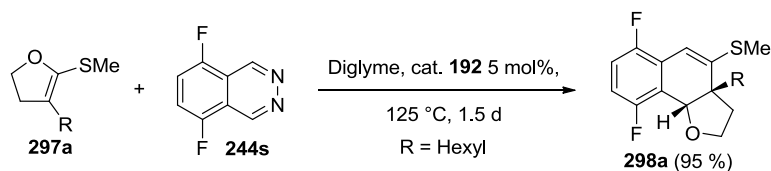

As in Scheme 92 the reaction proceeds to the tetrahydrofuran **298a** but in this case also the sulfur residue could have migrated which was not the case.

3.5.1 Mechanistic considerations

In analogy to the above mentioned cyclopropanation reaction, phthalazine **244** enters the catalytic cycle to form complex **184** which undergoes the cycloaddition with dihydrofuran **292a** to form adduct **299** which eliminates nitrogen and releases the catalyst **192** back into the cycle. The so formed highly reactive *o*-quinodimethan type intermediate **293a** rearranges in a novel fashion to create the tetrahydrofuran product **296a**, very different to those seen above (Scheme 95).

Scheme 95. Proposed catalytic cycle of the IEDDA reaction with 4-substituted dihydrofurans.

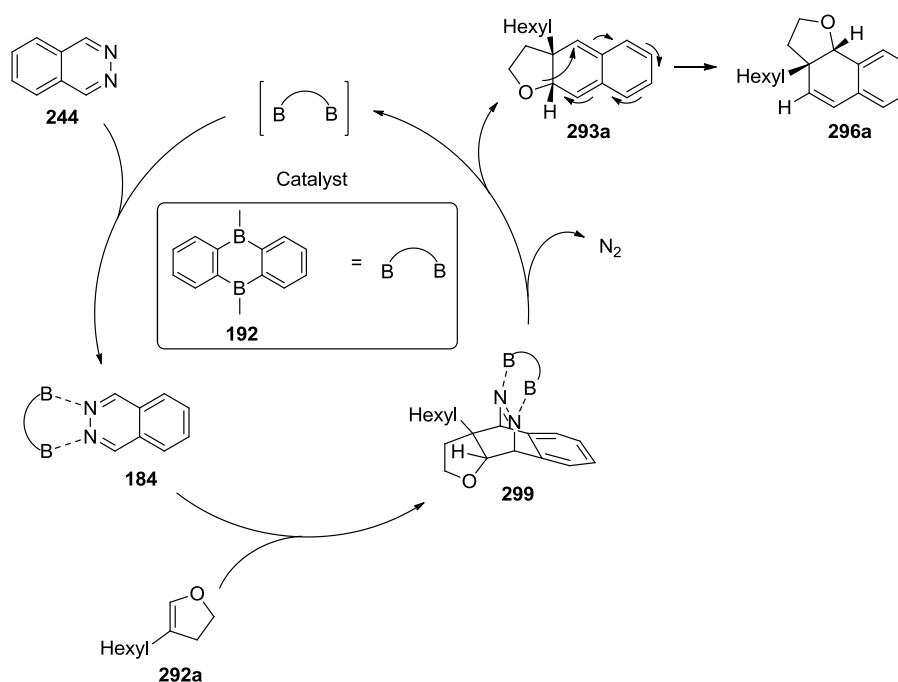

Again, a sigmatropic rearrangement is predicted on the basis of the Woodward-Hoffmann rules.^{278,279} Only this time, the σ -bond is broken and created on the oxygen atom and on the dihydronaphthalene fragment the alkoxy moiety migrates from position 1' to 9' (Scheme 96).

Scheme 96. Proposed [1,9]-sigmatropic rearrangement.

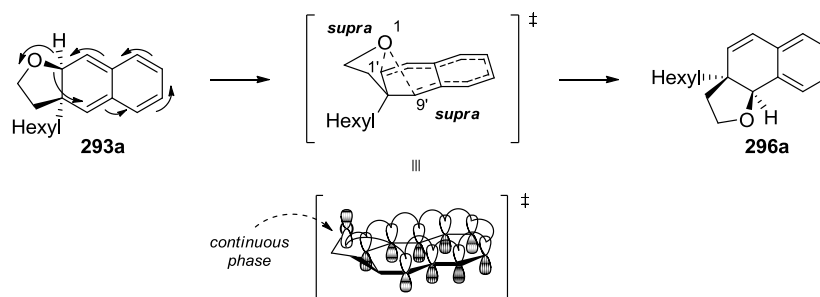

The topology of both, the alkoxy fragment and dihydronaphthalene fragment is supra facial, which leads to an ‘allowed’ supra-suprafacial [1,9]-sigmatropic rearrangement involving $4n+2$ ($n = 2$) electrons. And according to the Dewar⁴⁰-Zimmerman⁴¹ model no phase dislocation occurs constituting a Hückel topology which is ‘allowed’ in the case of $4n+2$ electrons.

Furthermore, calculations have been conducted on the basis of an simplified model with a reduced alkyl side chain (hexyl \rightarrow methyl). The located transition state showed an activation energy of $\Delta^\ddagger G^0_{(T=298)} = 35.9$ kcal and a Gibbs free energy of reaction $\Delta_r G^0_{(T=298)} = -21.3$ kcal. The activation energy is high but still feasible especially at a reaction temperature of 160°C. The obtained activation energy is in the range of the [1,5]-sigmatropic hydrogen shift or the cope rearrangement, both well reviewed experimentally and computationally.^{284–286} The same calculations have been performed for the reaction of 2-methylthiodihydrofuran **297a** ($R = \text{Me}$) and difluorophthalazine **244s** ($R = \text{Me}$), resulting in a lower activation energy of $\Delta^\ddagger G^0_{(T=298)} = 34.0$ kcal and a higher Gibbs free energy of reaction $\Delta_r G^0_{(T=298)} = -24.9$ kcal.

The transition structures of both reactions (Scheme 92 and Scheme 94) reflect very well the suggested sigmatropic rearrangement (Figure 29).

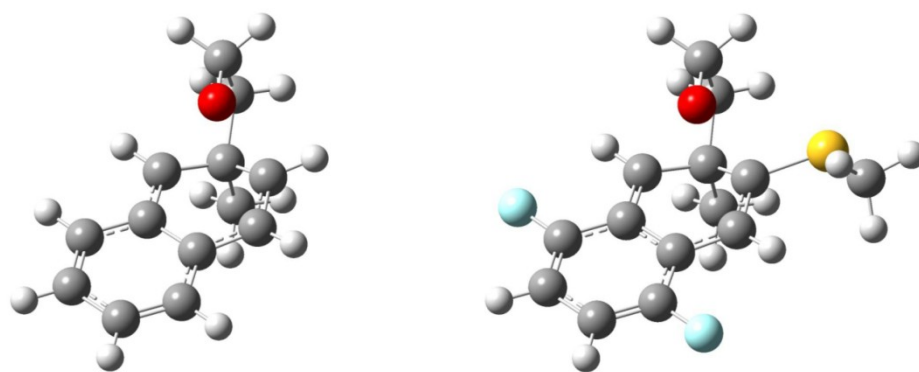
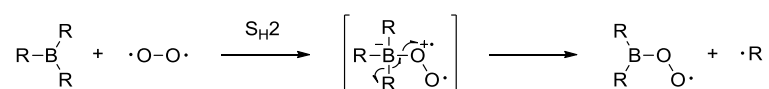

Figure 29. Transition state structures of [1,9]-sigmatropic rearrangement.

3.6 Development of an air stable catalyst for the IEDDA reaction

The catalyst **192** utilized so far is a highly oxygen sensitive compound as it is in general the case for organoboranes. But in the absence of oxygen trialkylboranes are surprisingly stable. For example, a solution of triethylborane in protic solvents such as water or methanol can be stored for months under argon atmosphere without decomposition.²⁸⁷ The autoxidation of boranes is a well studied process, initiated by homolytic substitution (S_H2) reaction between triplet oxygen and trialkylborane releasing an alkyl radical (Scheme 97).

Scheme 97. Autoxidation of alkylboranes in the presence of oxygen.



The production of radical intermediates in the autoxidation process of boranes has been widely applied as initiator in radical chemistry.^{288–290} Alkylboranes allow the radical initiation even at temperatures well below 0 °C compared to some of the common thermal radical initiators like 1,1'-azobisisobutyronitril (AIBN) or benzoyl peroxide. One of the first uses of organoboranes in radical chemistry was the oxygen induced conjugate addition to enones and enals by Brown and Kabalka (Scheme 98).^{291,292}

Scheme 98. Brown's mechanism for the conjugate addition of organoboranes to vinyl ketone.²⁸⁸

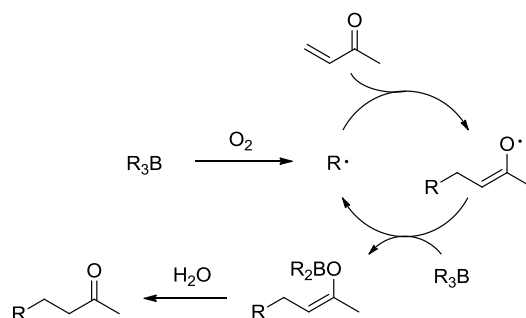

To avoid the autoxidation reaction to take place the empty p-orbital of boron has to be sterically shielding or occupied by a donor compound (Figure 30).

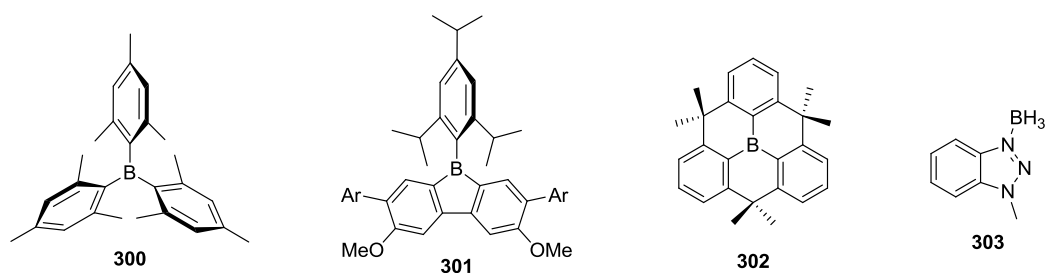
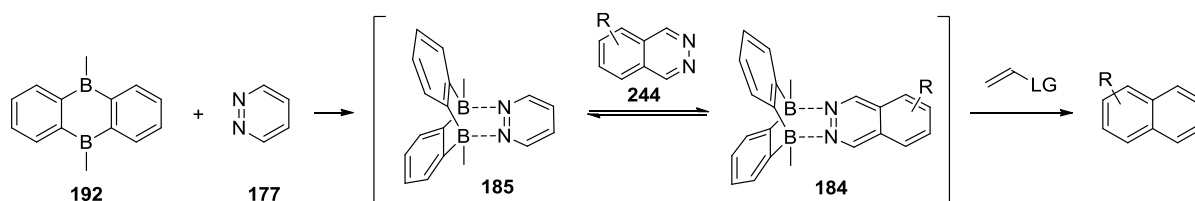

Figure 30. Boron compounds inert to air, stabilized by different principles.

The sterical shielding of boron was investigated in the late 50's by Brown and co-workers²⁹³, obtaining air-stable trimesylborane **300**. This method is still widely applied as seen in the air-stable borane **301**.²⁹⁴ A novel concept, is the stabilization of organoboranes by structurally constraining boron in a planar conformation²⁹⁵ as shown in the air-stable boradibenzopyrene **302**.²⁹⁶ By complexation with a Lewis base the Lewis acid gets stabilized as exemplified in the air-stable 1,2,3-triazol-borane complex **303**.²⁹⁷

The downside of all of these principles is the considerable reduction in Lewis acidity. But the most obvious and promising for herein purposes was the stabilization by complexation, since an intermediary complexation of catalyst **192** with phthalazine **244a** was needed anyways. But as complex **184** itself is prone to undergo an IEDDA reaction the diazine had to be changed to an under the reaction conditions inert compound. For this reason the nearby choice was the unreactive pyridazine **177**. Although the resulting complex is inert to the IEDDA reaction conditions it is believed that rapid exchange with phthalazine is maintaining the activity of the catalyst at the same time stabilizing against oxidation (Scheme 99).

Scheme 99. Concept of stabilization of catalyst **192** by pyridazine, while maintaining reactivity.



The complex **185** was prepared by complexation of **192** with pyridazine **177** in THF and following evaporation of THF and excessive pyridazine. The occurrence of an equilibrium between the pyridazine complex **185** and phthalazine complex **184** was tested by the addition of phthalazine **244** to complex **185** (Scheme 99). The recorded ¹H-NMR spectra show such an exchange in the mixture of complex **185** and phthalazine **244** by broad signals (arrows), which are in accordance with another equilibrium between the newly formed complex **184** and uncoordinated phthalazine **244** (Figure 31).

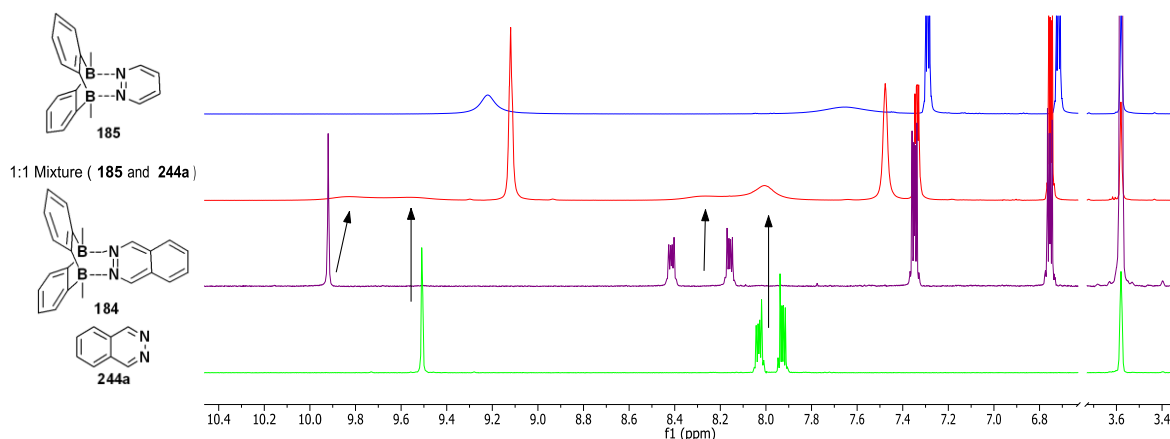

Figure 31. Stacked low field region of $^1\text{H-NMR}$ spectra of complex **185** (in blue), mixture of complex **185** and phthalazine **244a** (in red), complex **184** (in purple), and free phthalazine **244a** (in green). Singlet of $\text{THF-}d_8$ ($\delta = 3.58$ ppm) is used as the reference peak.

Furthermore, the solid complex **185** was exposed to air and the $^1\text{H-NMR}$ spectrum has been recorded at intervals to investigate its air stability (Figure 32).

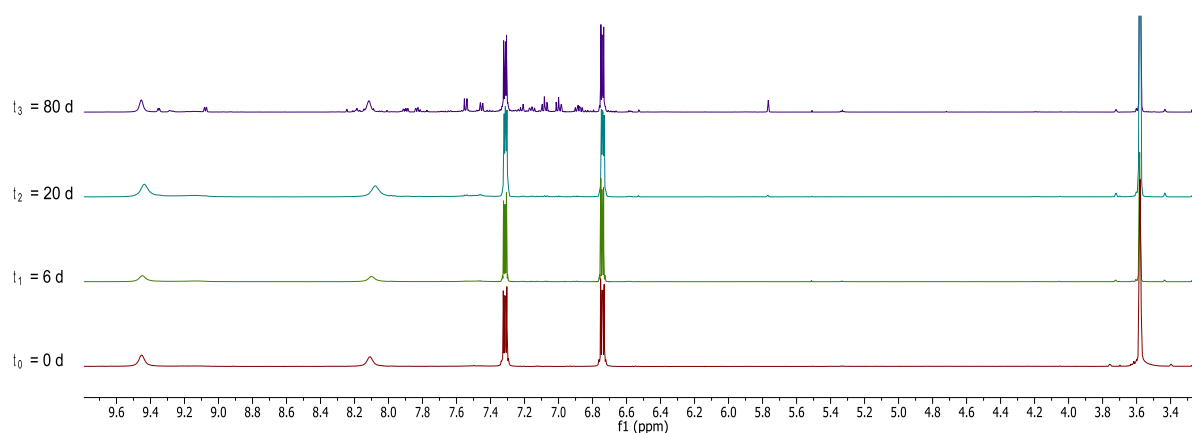
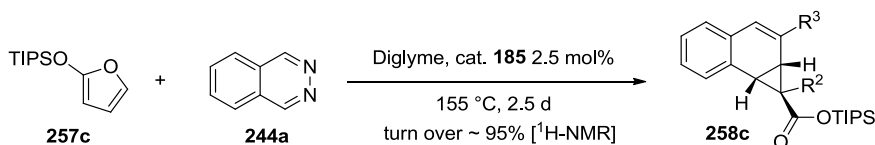

Figure 32. Stacked low field region of $^1\text{H-NMR}$ spectra of complex **185** exposed to air and measured after a certain time (t).

The complex **185** showed an unexpected high stability under air exposure, where after 20 days only slight decomposition occurs and even after 80 days major amounts of complex are remaining. This states a good tolerability towards air. In addition, after 20 days an IEDDA reaction was carried out with complex **185** as catalyst in the reaction of phthalazine **244a** and TIPS-oxyfuran **257c** (Scheme 100). The performance of complex **185** is retained and it almost attains full turnover similar to catalyst **192** shown in Table 10, which confirms the initial outset.

Scheme 100. IEDDA/cyclopropanation reaction catalyzed by complex **185** after air-exposure for 20 days.



3.7 References

- (138) Hartmann, K.-P.; Heuschmann, M. *Angew. Chem. Int. Ed. Engl.* **1989**, *28*, 1267–1268.
- (139) Hartmann, K.-P.; Heuschmann, M. *Tetrahedron* **2000**, *56*, 4213–4218.
- (140) Ernd, M.; Heuschmann, M.; Zipse, H. *Helv. Chim. Acta* **2005**, *88*, 1491–1518.
- (141) Rooshenas, P.; Hof, K.; Schreiner, P. R.; Williams, C. M. *Eur. J. Org. Chem.* **2011**, *2011*, 983–992.
- (142) Drew, M. G. B.; Yates, P. C.; Murphy, B. P.; Nelson, J.; Nelson, S. M. *Inorg. Chim. Acta* **1986**, *118*, 37–47.
- (143) Drew, M. G. B.; Yates, P. C.; Troch-Grimshaw, J.; Lavery, A.; McKillop, K. P.; Nelson, S. M.; Nelson, J. *J. Chem. Soc., Dalton Trans.* **1988**, 347.
- (144) Xiao, N.; Xu, Q.; Sun, J.; Chen, J. *Dalton Trans.* **2005**, 3250.
- (145) Austin, M.; Gebreyes, K.; Kuivila, H. G.; Swami, K.; Zubieta, J. A. *Organometallics* **1987**, *6*, 834–842.
- (146) Isobe, K.; Okeya, S.; Meanwell, N. J.; Smith, A. J.; Adams, H.; Maitlis, P. M. *J. Chem. Soc., Dalton Trans.* **1984**, 1215.
- (147) Rashidi, M.; Nabavizadeh, S. M.; Zare, A.; Jamali, S.; Puddephatt, R. J. *Inorg. Chem.* **2010**, *49*, 8435–8443.
- (148) Gabbaï, F. P.; Schier, A.; Riede, J.; Schier, A.; Hynes, M. J. *Chem. Commun.* **1998**, 897–898.
- (149) Emslie, D. J. H.; Piers, W. E.; Parvez, M. *Angew. Chem.* **2003**, *115*, 1290–1293.
- (150) Lorbach, A.; Bolte, M.; Li, H.; Lerner, H.-W.; Holthausen, M. C.; Jäkle, F.; Wagner, M. *Angew. Chem. Int. Ed.* **2009**, *48*, 4584–4588.
- (151) Kessler, S. N. *Inverse Electron Demand Diels-Alder Reaction of 1,2-Diazines for the Synthesis of Substituted Arenes*; University of Basel: Basel, Switzerland, 2008.
- (152) Clément, R. M. *C. R. Acad. Sc. Paris* **1965**, *261*, 4436–4438.

- (153) Siebert, W.; Schmidt, M.; Gast, E. *J. Organomet. Chem.* **1969**, *20*, 29–33.
- (154) Schulz, H.; Pritzkow, H.; Siebert, W. *Chem. Ber.* **1991**, *124*, 2203–2207.
- (155) Müller, P.; Gangnus, B.; Pritzkow, H.; Schulz, H.; Stephan, M.; Siebert, W. *J. Organomet. Chem.* **1995**, *487*, 235–243.
- (156) Müller, P.; Pritzkow, H.; Siebert, W. *J. Organomet. Chem.* **1996**, *524*, 41–47.
- (157) Schacht, W.; Kaufmann, D. *J. Organomet. Chem.* **1987**, *331*, 139–152.
- (158) Bettinger, H. F.; Filthaus, M. *J. Org. Chem.* **2007**, *72*, 9750–9752.
- (159) Kaufmann, D. *Chem. Ber.* **1987**, *120*, 901–905.
- (160) Bader, S.; Kessler, S.; Wegner, H. *Synthesis* **2010**, *2010*, 2759–2762.
- (161) Febenbecker, A.; Schulz, H.; Pritzkow, H.; Siebert, W. *Chem. Ber.* **1990**, *123*, 2273–2278.
- (162) Lorbach, A.; Bolte, M.; Lerner, H.-W.; Wagner, M. *Chem. Commun.* **2010**, *46*, 3592.
- (163) Schulze, T.; Letsch, J.; Klemm, E. *J. Polym. Sci., Part A: Polym. Chem.* **1996**, *34*, 81–87.
- (164) Zhou, A.; Pittman Jr., C. U. *Synthesis* **2006**, *2006*, 37–48.
- (165) Zhou, A.; Pittman, C. U. *J. Comb. Chem.* **2006**, *8*, 262–267.
- (166) Uno, H.; Okada, S.; Suzuki, H. *Tetrahedron* **1991**, *47*, 6231–6242.
- (167) Taskinen, E.; Buchardt, O.; Dale, J.; Gaupset, G.; Schroll, G.; Altona, C. *Acta Chem. Scand.* **1975**, *29b*, 245–248.
- (168) Sauer, J.; Bäuerlein, P.; Ebenbeck, W.; Fühlhuber, H.-D.; Gousetis, C.; Wernthaler, K. *Eur. J. Org. Chem.* **2001**, *2001*, 3999–4008.
- (169) Boger, D. L.; Panek, J. S.; Meier, M. M. *J. Org. Chem.* **1982**, *47*, 895–897.
- (170) Chenard, B. L.; Ronau, R. T.; Schulte, G. K. *J. Org. Chem.* **1988**, *53*, 5175–5177.
- (171) Carlson, R.; Nilsson, Å.; Strömquist, M.; Stenman, U.-H.; Rasmussen, P. B.; Lawesson, S.-O.; Williams, R. V.; Mahedevan, R. *Acta Chem. Scand.* **1983**, *37b*, 7–13.
- (172) Snyder, D. C. *J. Organomet. Chem.* **1986**, *301*, 137–144.
- (173) Cone, M. C.; Melville, C. R.; Gore, M. P.; Gould, S. J. *J. Org. Chem.* **1993**, *58*, 1058–1061.
- (174) Tuchinda, P.; Pohmakotr, M.; Munyoo, B.; Reutrakul, V.; Santisuk, T. *Phytochemistry* **2000**, *53*, 1079–1082.
- (175) Lang, S.; Groth, U. *Angew. Chem. Int. Ed.* **2009**, *48*, 911–913.
- (176) Kessler, S. N.; Neuburger, M.; Wegner, H. A. *Eur. J. Org. Chem.* **2011**, *2011*, 3238–3245.

- (177) Fernández Sainz, Y.; Raw, S. A.; Taylor, R. J. K. *J. Org. Chem.* **2005**, *70*, 10086–10095.
- (178) Chavan, S. P.; Dhondge, V. D.; Patil, S. S.; Rao, Y. T. S.; Govande, C. A. *Tetrahedron: Asymmetry* **1997**, *8*, 2517–2518.
- (179) Schmalz, H.-G.; De Koning, C. B.; Bernicke, D.; Siegel, S.; Pfletschinger, A. *Angew. Chem. Int. Ed.* **1999**, *38*, 1620–1623.
- (180) Hagiwara, H.; Okabe, T.; Ono, H.; Kamat, V. P.; Hoshi, T.; Suzuki, T.; Ando, M. *J. Chem. Soc., Perkin Trans. 1* **2002**, 895–900.
- (181) Mori, K. *Tetrahedron: Asymmetry* **2005**, *16*, 685–692.
- (182) Kraus, G. A.; Jeon, I. *Org. Lett.* **2006**, *8*, 5315–5316.
- (183) Srikrishna, A.; Satyanarayana, G. *Org. Lett.* **2004**, *6*, 2337–2339.
- (184) Fukushima, M.; Morii, A.; Hoshi, T.; Suzuki, T.; Hagiwara, H. *Tetrahedron* **2007**, *63*, 7154–7164.
- (185) Näf, F.; Ohloff, G. *Helv. Chim. Acta* **1974**, *57*, 1868–1870.
- (186) Yamada, K.; Kyotani, Y.; Manabe, S.; Suzuki, M. *Tetrahedron* **1979**, *35*, 293–298.
- (187) Magee, T. V.; Stork, G.; Fludzinski, P. *Tetrahedron Lett.* **1995**, *36*, 7607–7610.
- (188) Srikrishna, A.; Satyanarayana, G. *Tetrahedron: Asymmetry* **2005**, *16*, 3992–3997.
- (189) Oishi, E.; Taido, N.; Iwamoto, K.; Miyashita, A.; Higashino, T. *Chem. Pharm. Bull.* **1990**, *38*, 3268–3272.
- (190) Jonas, V.; Frenking, G. *J. Chem. Soc., Chem. Commun.* **1994**, 1489.
- (191) Grote, R.; Chen, Y.; Zeeck, A.; Chen, Z. X.; Zähler, H.; Mischnick-Lübbecke, P.; König, W. A. *J. Antibiot.* **1988**, *41*, 595–601.
- (192) Cho, J. Y.; Kwon, H. C.; Williams, P. G.; Jensen, P. R.; Fenical, W. *Org. Lett.* **2006**, *8*, 2471–2474.
- (193) Winter, J. M.; Jansma, A. L.; Handel, T. M.; Moore, B. S. *Angew. Chem. Int. Ed.* **2009**, *48*, 767–770.
- (194) Haack, T.; Fattori, R.; Napoletano, M.; Pellacini, F.; Fronza, G.; Raffaini, G.; Ganazzoli, F. *Bioorg. Med. Chem.* **2005**, *13*, 4425–4433.
- (195) Herberich, B.; Cao, G.-Q.; Chakrabarti, P. P.; Falsey, J. R.; Pettus, L.; Rzasa, R. M.; Reed, A. B.; Reichelt, A.; Sham, K.; Thaman, M.; Wurz, R. P.; Xu, S.; Zhang, D.; Hsieh, F.; Lee, M. R.; Syed, R.; Li, V.; Grosfeld, D.; Plant, M. H.; Henkle, B.; Sherman, L.; Middleton, S.; Wong, L. M.; Tasker, A. S. *J. Med. Chem.* **2008**, *51*, 6271–6279.

- (196) Pettus, L. H.; Xu, S.; Cao, G.-Q.; Chakrabarti, P. P.; Rzasas, R. M.; Sham, K.; Wurz, R. P.; Zhang, D.; Middleton, S.; Henkle, B.; Plant, M. H.; Saris, C. J. M.; Sherman, L.; Wong, L. M.; Powers, D. A.; Tudor, Y.; Yu, V.; Lee, M. R.; Syed, R.; Hsieh, F.; Tasker, A. S. *J. Med. Chem.* **2008**, *51*, 6280–6292.
- (197) Miller-Moslin, K.; Peukert, S.; Jain, R. K.; McEwan, M. A.; Karki, R.; Llamas, L.; Yusuff, N.; He, F.; Li, Y.; Sun, Y.; Dai, M.; Perez, L.; Michael, W.; Sheng, T.; Lei, H.; Zhang, R.; Williams, J.; Bourret, A.; Ramamurthy, A.; Yuan, J.; Guo, R.; Matsumoto, M.; Vattay, A.; Maniara, W.; Amaral, A.; Dorsch, M.; Kelleher, J. F. *J. Med. Chem.* **2009**, *52*, 3954–3968.
- (198) Zhang, S.; Zhao, Y.; Liu, Y.; Chen, D.; Lan, W.; Zhao, Q.; Dong, C.; Xia, L.; Gong, P. *Eur. J. Med. Chem.* **2010**, *45*, 3504–3510.
- (199) Martínez, V.; Burgos, C.; Alvarez-Builla, J.; Fernández, G.; Domingo, A.; García-Nieto, R.; Gago, F.; Manzanares, I.; Cuevas, C.; Vaquero, J. J. *J. Med. Chem.* **2004**, *47*, 1136–1148.
- (200) Dalla Via, L.; Gia, O.; Marciani Magno, S.; Braga, A.; González-Gómez, J. C.; Pérez-Montoto, L. G.; Uriarte, E. *Bioorg. Med. Chem.* **2010**, *18*, 5708–5714.
- (201) Sivakumar, R.; Kishore Gnanasam, S.; Ramachandran, S.; Thomas Leonard, J. *Eur. J. Med. Chem.* **2002**, *37*, 793–801.
- (202) Watanabe, N.; Adachi, H.; Takase, Y.; Ozaki, H.; Matsukura, M.; Miyazaki, K.; Ishibashi, K.; Ishihara, H.; Kodama, K.; Nishino, M.; Kakiki, M.; Kabasawa, Y. *J. Med. Chem.* **2000**, *43*, 2523–2529.
- (203) Achelle, S.; Plé, N.; Turck, A. *RSC Advances* **2011**, *1*, 364.
- (204) Liu, Y.; Zhang, F.; He, C.; Wu, D.; Zhuang, X.; Xue, M.; Feng, X. *Chem. Commun.* **2012**.
- (205) Kettler, P. B.; Chang, Y.-D.; Chen, Q.; Zubieta, J.; Abrams, M. J.; Larsen, S. K. *Inorg. Chim. Acta* **1995**, *231*, 13–20.
- (206) Kuzelka, J.; Farrell, J. R.; Lippard, S. J. *Inorg. Chem.* **2003**, *42*, 8652–8662.
- (207) Bullock, G.; Cook, A.; Foster, A.; Rosenberg, L.; Thompson, L. K. *Inorg. Chim. Acta* **1985**, *103*, 207–215.
- (208) Yamaguchi, T.; Koike, T.; Akita, M. *Organometallics* **2010**, *29*, 6493–6502.
- (209) Shi, L.; Su, J.; Wu, Z. *Inorg. Chem.* **2011**, *50*, 5477–5484.
- (210) Paolucci, G.; Stelluto, S.; Sitran, S.; Ajò, D.; Benetollo, F.; Polo, A.; Bombieri, G. *Inorg. Chim. Acta* **1992**, *193*, 57–75.
- (211) Barrios, A. M.; Lippard, S. J. *J. Am. Chem. Soc.* **2000**, *122*, 9172–9177.

- (212) Xu, Y.; Fischer, A.; Duan, L.; Tong, L.; Gabrielsson, E.; Åkermark, B.; Sun, L. *Angew. Chem. Int. Ed.* **2010**, *49*, 8934–8937.
- (213) Kolb, H. C.; VanNieuwenhze, M. S.; Sharpless, K. B. *Chem. Rev.* **1994**, *94*, 2483–2547.
- (214) Patel, N. R. In *Chemistry of Heterocyclic Compounds: A Series Of Monographs*; Castle, R. N., Ed.; John Wiley & Sons, Inc.: Hoboken, NJ, USA; Vol. 27, pp. 323–760.
- (215) Brown, D. D. J. *Cinnolines and Phthalazines: Supplement II, Volume 64*; Chemistry of Heterocyclic Compounds: A Series Of Monographs; 2005.
- (216) Yamamoto, Y.; Gobec, S. *Science of synthesis : Houben-Weyl methods of molecular transformations. Category 2, Vol. 16, Hetarenes and related ring systems. Six-membered hetarenes with two identical heteroatoms*; Georg Thieme; New York, London, 2004.
- (217) Margetić, D.; Murata, Y.; Komatsu, K.; Marinić, Ž. *Helv. Chim. Acta* **2009**, *92*, 298–312.
- (218) Girardot, M.; Nomak, R.; Snyder, J. K. *J. Org. Chem.* **1998**, *63*, 10063–10068.
- (219) Baumann, L.; Folkerts, A.; Imming, P.; Klindert, T.; Massa, W.; Seitz, G.; Wocadlo, S. *Liebigs Ann.* **1995**, *1995*, 661–666.
- (220) Seitz, G.; Hoferichter, R.; Mohr, R. *Angew. Chem. Int. Ed. Engl.* **1987**, *26*, 332–334.
- (221) Haider, N.; Loll, C. *J. Heterocycl. Chem.* **1994**, *31*, 357–360.
- (222) Haider, N. *Tetrahedron* **1991**, *47*, 3959–3968.
- (223) Gabriel, S.; Neumann, A. *Ber. Dtsch. Chem. Ges.* **1893**, *26*, 521–527.
- (224) Gabriel, S.; Pinkus, G. *Ber. Dtsch. Chem. Ges.* **1893**, *26*, 2210–2216.
- (225) Meresse, P.; Bertounesque, E.; Imbert, T.; Monneret, C. *Tetrahedron* **1999**, *55*, 12805–12818.
- (226) Tsoungas, P. G.; Searcey, M. *Tetrahedron Lett.* **2001**, *42*, 6589–6592.
- (227) Wharton, C. J.; Wrigglesworth, R. *J. Chem. Soc., Perkin Trans. 1* **1985**, 809.
- (228) A. Joule, J.; Karim Karim, A.; Armengol, M. *Heterocycles* **2001**, *55*, 2139.
- (229) Kotali, A.; Lafazanis, I.; Harris, P. *Synthesis* **2009**, *2009*, 836–840.
- (230) Chan, C.-W.; Zhou, Z.; Chan, A. S. C.; Yu, W.-Y. *Org. Lett.* **2010**, *12*, 3926–3929.
- (231) G. Tsoungas, P.; Cordopatis, P.; Gardikis, Y.; Potamitis, C.; Zervou, M. *Heterocycles* **2011**, *83*.

- (232) Amberg, W.; Bennani, Y. L.; Chadha, R. K.; Crispino, G. A.; Davis, W. D.; Hartung, J.; Jeong, K. S.; Ogino, Y.; Shibata, T.; Sharpless, K. B. *J. Org. Chem.* **1993**, *58*, 844–849.
- (233) Becker, H.; King, S. B.; Taniguchi, M.; Vanhessche, K. P. M.; Sharpless, K. B. *J. Org. Chem.* **1995**, *60*, 3940–3941.
- (234) Sun, X.-Y.; Hu, C.; Deng, X.-Q.; Wei, C.-X.; Sun, Z.-G.; Quan, Z.-S. *Eur. J. Med. Chem.* **2010**, *45*, 4807–4812.
- (235) Carling, R. W.; Moore, K. W.; Street, L. J.; Wild, D.; Isted, C.; Leeson, P. D.; Thomas, S.; O'Connor, D.; McKernan, R. M.; Quirk, K.; Cook, S. M.; Atack, J. R.; Wafford, K. A.; Thompson, S. A.; Dawson, G. R.; Ferris, P.; Castro, J. L. *J. Med. Chem.* **2004**, *47*, 1807–1822.
- (236) Stefan K., R. *Tetrahedron Lett.* **1981**, *22*, 345–348.
- (237) Mongin, F. *Tetrahedron* **2001**, *57*, 4059–4090.
- (238) Snieckus, V. *Chem. Rev.* **1990**, *90*, 879–933.
- (239) Comins, D. L.; Brown, J. D. *Tetrahedron Lett.* **1981**, *22*, 4213–4216.
- (240) Comins, D. L.; Brown, J. D. *J. Org. Chem.* **1984**, *49*, 1078–1083.
- (241) Comins, D. L.; Killpack, M. O. *J. Org. Chem.* **1987**, *52*, 104–109.
- (242) Comins, D. L.; Killpack, M. O. *J. Org. Chem.* **1990**, *55*, 69–73.
- (243) Comins, D. L. *Synlett* **1992**, *1992*, 615–625.
- (244) Fraenkel, G.; Qiu, F. *J. Am. Chem. Soc.* **1997**, *119*, 3571–3579.
- (245) Fraenkel, G.; Chow, A.; Fleischer, R.; Liu, H. *J. Am. Chem. Soc.* **2004**, *126*, 3983–3995.
- (246) Stanetty, P.; Mihovilovic, M. D. *J. Org. Chem.* **1997**, *62*, 1514–1515.
- (247) Slocum, D. W.; Carroll, A.; Dietzel, P.; Eilerman, S.; Culver, J. P.; McClure, B.; Brown, S.; Holman, R. W. *Tetrahedron Lett.* **2006**, *47*, 865–868.
- (248) Harrison, I. T.; Lewis, B.; Nelson, P.; Rooks, W.; Roszkowski, A.; Tomolonis, A.; Fried, J. H. *J. Med. Chem.* **1970**, *13*, 203–205.
- (249) Kitamura, T.; Yamane, M.; Inoue, K.; Todaka, M.; Fukatsu, N.; Meng, Z.; Fujiwara, Y. *J. Am. Chem. Soc.* **1999**, *121*, 11674–11679.
- (250) Lorbach, A.; Reus, C.; Bolte, M.; Lerner, H.-W.; Wagner, M. *Adv. Synth. Catal.* **2010**, *352*, 3443–3449.
- (251) Tietze, L. F. *Chem. Rev.* **1996**, *96*, 115–136.
- (252) Tietze, L.-F.; Brasche, G.; Gericke, K. M. *Domino reactions in organic synthesis*; Wiley-VCH: Weinheim Germany, 2006.

- (253) Neuschütz, K.; Velker, J.; Neier, R. *Synthesis* **1998**, 1998, 227–255.
- (254) Boger, D. L. *Chem. Rev.* **1986**, 86, 781–793.
- (255) Yuan, Z. Q.; Ishikawa, H.; Boger, D. L. *Org. Lett.* **2005**, 7, 741–744.
- (256) Elliott, G. I.; Velcicky, J.; Ishikawa, H.; Li, Y.; Boger, D. L. *Angew. Chem. Int. Ed.* **2006**, 45, 620–622.
- (257) Sasaki, Y.; Kato, D.; Boger, D. L. *J. Am. Chem. Soc.* **2010**, 132, 13533–13544.
- (258) Choi, Y.; Ishikawa, H.; Velcicky, J.; Elliott, G. I.; Miller, M. M.; Boger, D. L. *Org. Lett.* **2005**, 7, 4539–4542.
- (259) Ishikawa, H.; Elliott, G. I.; Velcicky, J.; Choi, Y.; Boger, D. L. *J. Am. Chem. Soc.* **2006**, 128, 10596–10612.
- (260) Kato, D.; Sasaki, Y.; Boger, D. L. *J. Am. Chem. Soc.* **2010**, 132, 3685–3687.
- (261) Bodwell, G. J.; Li, J. *Angew. Chem. Int. Ed.* **2002**, 41, 3261–3262.
- (262) Rodriguez-Hahn, L.; Esquivel, B.; Sanchez, A. A.; Cardenas, J.; Tovar, O. G.; Soriano-Garcia, M.; Toscano, A. *J. Org. Chem.* **1988**, 53, 3933–3936.
- (263) Xu, G.; Peng, L.; Niu, X.; Zhao, Q.; Li, R.; Sun, H. *Helv. Chim. Acta* **2004**, 87, 949–955.
- (264) Gorin, D. J.; Dubé, P.; Toste, F. D. *J. Am. Chem. Soc.* **2006**, 128, 14480–14481.
- (265) Tenaglia, A.; Marc, S.; Giordano, L.; De Raggi, I. *Angew. Chem. Int. Ed.* **2011**, 50, 9062–9065.
- (266) Iwasawa, N.; Shido, M.; Maeyama, K.; Kusama, H. *J. Am. Chem. Soc.* **2000**, 122, 10226–10227.
- (267) Kusama, H.; Shiozawa, F.; Shido, M.; Iwasawa, N. *Chem. Lett.* **2002**, 124–124.
- (268) Müller, P.; Toujas, J.-L.; Bernardinelli, G. *Helv. Chim. Acta* **2000**, 83, 1525–1534.
- (269) Tenaglia, A.; Marc, S.; Giordano, L.; De Raggi, I. *Angew. Chem.* **2011**, 123, 9228–9231.
- (270) McNamara, O. A.; Maguire, A. R. *Tetrahedron* **2011**, 67, 9–40.
- (271) McCullough, J. J. *Acc. Chem. Res.* **1980**, 13, 270–276.
- (272) Segura, J. L.; Martín, N. *Chem. Rev.* **1999**, 99, 3199–3246.
- (273) Nicolaou, K. C.; Gray, D.; Tae, J. *Angew. Chem. Int. Ed.* **2001**, 40, 3675–3678.
- (274) Nicolaou, K. C.; Gray, D.; Tae, J. *Angew. Chem. Int. Ed.* **2001**, 40, 3679–3683.
- (275) Nicolaou, K. C.; Gray, D. L. F.; Tae, J. *J. Am. Chem. Soc.* **2003**, 126, 613–627.
- (276) Ghereg, D.; Ech-Cherif El Kettani, S.; Lazraq, M.; Ranaivonjatovo, H.; Schoeller, W. W.; Escudié, J.; Gornitzka, H. *Chem. Commun.* **2009**, 4821.
- (277) Shimizu, A.; Tobe, Y. *Angew. Chem. Int. Ed.* **2011**, 50, 6906–6910.

- (278) Hoffmann, R.; Woodward, R. B. *Acc. Chem. Res.* **1968**, *1*, 17–22.
- (279) Woodward, R. B.; Hoffmann, R. *Angew. Chem. Int. Ed. Engl.* **1969**, *8*, 781–853.
- (280) Brown, H. C.; Jadhav, P. K.; Mandal, A. K. *Tetrahedron* **1981**, *37*, 3547–3587.
- (281) Brown, H. C.; Singaram, B. *Acc. Chem. Res.* **1988**, *21*, 287–293.
- (282) Midland, M. M. *Chem. Rev.* **1989**, *89*, 1553–1561.
- (283) Satcharoen, V.; McLean, N. J.; Kemp, S. C.; Camp, N. P.; Brown, R. C. D. *Org. Lett.* **2007**, *9*, 1867–1869.
- (284) Houk, K. N.; Li, Y.; Evanseck, J. D. *Angew. Chem. Int. Ed. Engl.* **1992**, *31*, 682–708.
- (285) Hess, B. A.; Baldwin, J. E. *J. Org. Chem.* **2002**, *67*, 6025–6033.
- (286) Alabugin, I. V.; Manoharan, M.; Breiner, B.; Lewis, F. D. *J. Am. Chem. Soc.* **2003**, *125*, 9329–9342.
- (287) Yorimitsu, H.; Nakamura, T.; Shinokubo, H.; Oshima, K.; Omoto, K.; Fujimoto, H. *J. Am. Chem. Soc.* **2000**, *122*, 11041–11047.
- (288) Ollivier, C.; Renaud, P. *Chem. Rev.* **2001**, *101*, 3415–3434.
- (289) Darmency, V.; Renaud, P. In *Radicals in Synthesis I*; Gansäuer, A., Ed.; Springer-Verlag: Berlin/Heidelberg; Vol. 263, pp. 71–106.
- (290) Renaud, P.; Beauseigneur, A.; Brecht-Forster, A.; Becattini, B.; Darmency, V.; Kandhasamy, S.; Montermini, F.; Ollivier, C.; Panchaud, P.; Pozzi, D.; Scanlan, E. M.; Schaffner, A.-P.; Weber, V. *Pure Appl. Chem.* **2007**, *79*, 223–233.
- (291) Kabalka, G. W.; Brown, H. C.; Suzuki, A.; Honma, S.; Arase, A.; Itoh, M. *J. Am. Chem. Soc.* **1970**, *92*, 710–712.
- (292) Brown, H. C.; Kabalka, G. W. *J. Am. Chem. Soc.* **1970**, *92*, 714–716.
- (293) Brown, H. C.; Dodson, V. H. *J. Am. Chem. Soc.* **1957**, *79*, 2302–2306.
- (294) Yamaguchi, S.; Shirasaka, T.; Akiyama, S.; Tamao, K. *J. Am. Chem. Soc.* **2002**, *124*, 8816–8817.
- (295) Araneda, J. F.; Neue, B.; Piers, W. E. *Angew. Chem. Int. Ed.* **2012**, *51*, 9977–9979.
- (296) Zhou, Z.; Wakamiya, A.; Kushida, T.; Yamaguchi, S. *J. Am. Chem. Soc.* **2012**, *134*, 4529–4532.
- (297) Liao, W.; Chen, Y.; Liu, Y.; Duan, H.; Petersen, J. L.; Shi, X. *Chem. Commun.* **2009**, 6436.

4 Summary and Conclusion

Herein, a new and very successful principle of activation of 1,2-diazine with a bidentate Lewis acid catalyst for the IEDDA reaction is presented. A new, very direct method for the synthesis of 5,10-dimethyl-5,10-dihydroboranthrene as the catalyst in the IEDDA reaction of 1,2-diazines was devised, enabling the preparation on a gram scale (Scheme 101).

Scheme 101. Convenient three step procedure for the synthesis of 5,10-dimethyl-5,10-dihydroboranthrene.

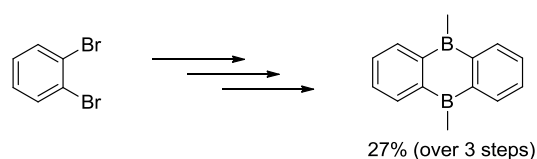

In addition, on an exploratory basis, the in situ derivatization with chiral additives has been studied as well as an air-tolerable second generation catalyst was developed.

The scope of dienophiles was examined reaching from silylacetylene, enoethers, *O,O*- or *N,O*-keteneacetals to enamines from ketone and aldehyde generated in situ (Scheme 102).

Scheme 102. Catalyzed IEDDA reaction of phthalazine with a variety of different dienophiles.

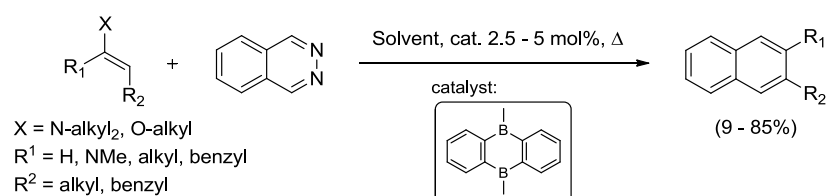

Since pyridazine did not react in the catalyzed IEDDA reaction, the scope of dienes was mainly focused on phthalazine derivatives. At first the unavailability of a general method for the synthesis of benzo-substituted phthalazines reduced the range of applied dienes. This gap was filled with the introduction of a one-pot synthesis of substituted phthalazines and pyridazino-aromatics starting from aromatic aldehydes (Scheme 103).

Scheme 103. One-pot synthesis of substituted phthalazines and pyridazino-aromatics.

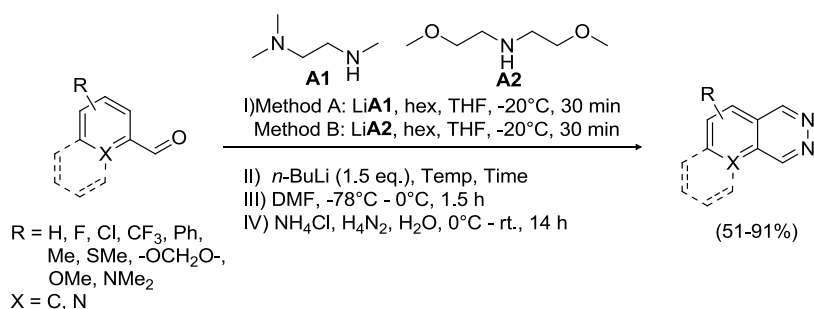

Thus, the developed method comprised a novel two-step strategy for the preparation of substituted naphthalenes, which was nicely displayed in the synthesis of (\pm)-Naproxen (Scheme 104).

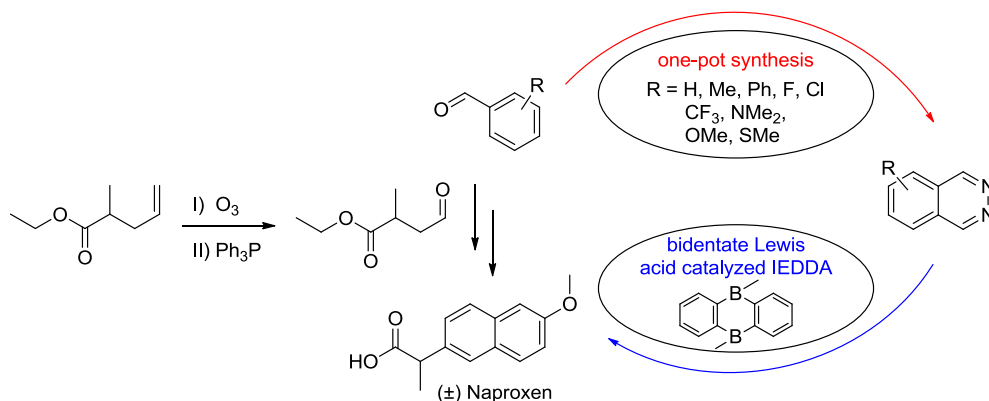
 Scheme 104. Novel two step synthesis of substituted Naphthalenes starting from benzaldehydes, applied in the synthesis of (\pm)-Naproxen.

By the application of electron rich furans, a novel domino IEDDA/cyclopropanation reaction occurred leading to cyclopropadihydronaphthalenes in excellent yields. The method was elaborated and the scope was illustrated by 20 examples (Scheme 105). Investigation of the mechanism via computational methods lead to the proposal of a concerted migration, formulated as [3,9]-sigmatropic rearrangement, on the basis of either the Woodward-Hoffmann rules or the Dewar-Zimmerman model.

Scheme 107. Summarized bidentate Lewis acid catalyzed IEDDA reaction of phthalazine with its catalytic cycle.

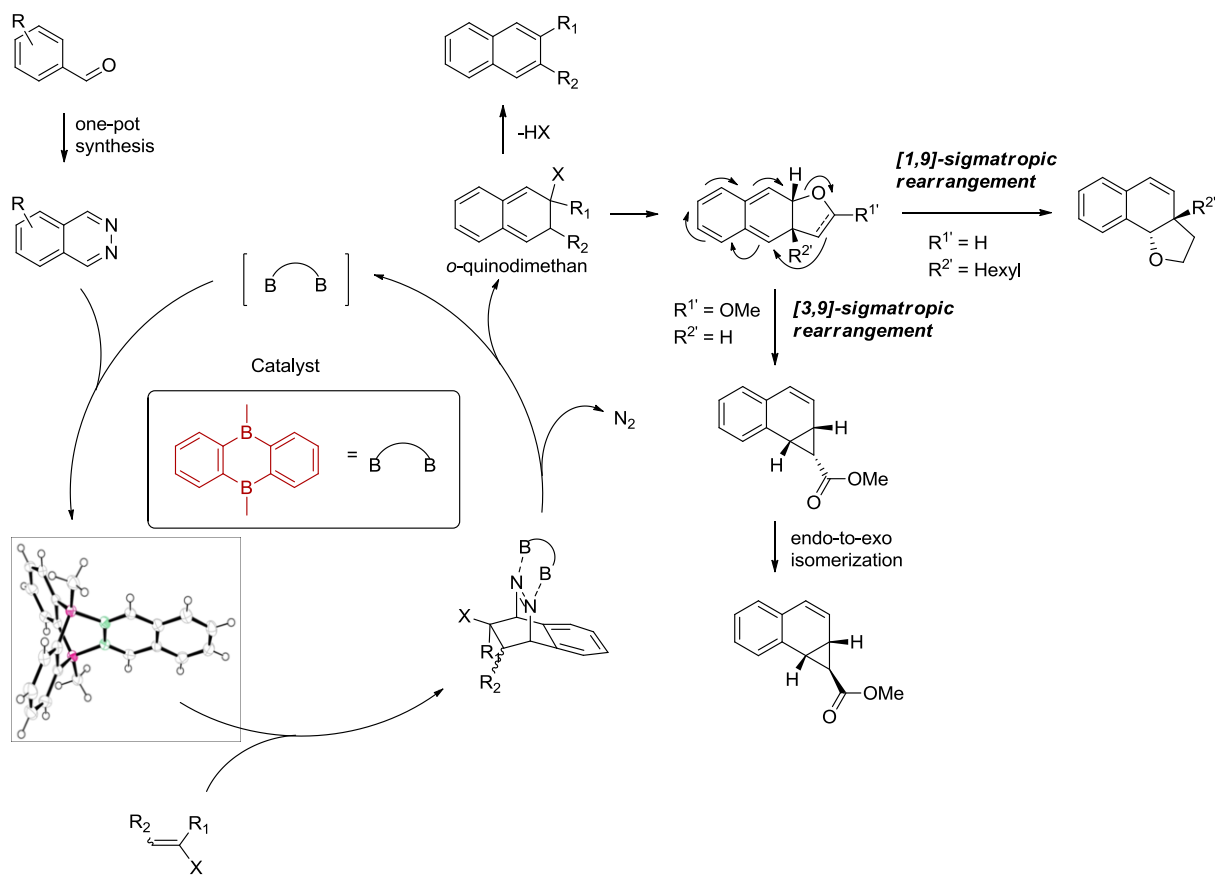

5 Experimental Part

5.1 General information

Reagents and Solvents: All reagents and solvents were obtained from either Sigma-Aldrich, Acros, Fluorochem, Alfa, VWR, Fluka, ABCR, Apollo or TCI and were used as received unless otherwise stated. Dry solvents were obtained from commercial sources, from a Pure-Solv™ drying system or dried over molecular sieve. THF was predried over CaCl₂ and distilled from potassium and benzophenone. Oxygen-free solvents for the catalytic reaction was obtained from commercial sources or via freeze-pump-thaw cycling. Technical grade solvents for extraction and column chromatography were bulb-to-bulb distilled prior to usage.

Reactions: Moisture sensitive reactions were set up in dry glassware, which was heated up to 200 °C and dried in several evacuation-flush-cycles or just flushed by nitrogen or argon. Air sensitive reactions were set up under nitrogen atmosphere, either in the hood or in a nitrogen glove-box. Especially all catalyzed reactions were set up in the glove-box. Pressurized reactions were set up in a glass pressure tube.

Photolysis: For the rearomatization reaction was used either a 8 Watt 3UV lamp from UVP with 302 nm or a Rayonet photoreactor with 300 nm lamps.

Chromatography: The thin layer chromatography was conducted on aluminum supported silica gel 60 F₂₅₄ with a thickness of 0.2 mm from Merck and detected with a GAMAG UV cabinet at 254 or 365 nm or developed with KMnO₄, vanillin, ninhydrin or iodine. For the preparative scale thin layer chromatography was used 1 or 2 mm silica gel coated glass plates (20 × 20 cm) from Analtech. For the column chromatography was used silica gel 60 (40 – 63 μm) from Fluka, Sigma-Aldrich, Merck, SiliCycle Inc.

¹H-, ¹³C-, ¹¹B- and ¹⁹F-NMR: Experiments were performed on a Bruker Avance 500 (500/125.8/57/376 MHz), Bruker DPX-NMR (400/100.6 MHz) or Bruker BZH-NMR (250 MHz) at 25 °C. The 500 MHz NMR machine was utilized to measure two dimensional spectra. Chemical shifts are reported in parts per million (ppm) relative to solvent peak or trimethylsilane (TMS). Coupling constants (*J*) are reported in Hertz (Hz). NMR-solvents were purchased from Cambridge Isotope Laboratories, Inc. or ARMAR. The multiplicities are written as: *s*=singlet, *sb*=broad singlet, *d*=doublet, *t*=triplet, *m*=multiplet and their combinations, such as *dd*=doublet of a doublet.

Mass Spectrometry: Electron spray mass spectrometry was measured on a Bruker esquire 3000 plus. For GC/MS-analysis a Hewlett Packard 5890 Series II gas chromatography system, with a Macherey Nagel OPTIMA 1 Me₂Si column (25 m × 0.2 mm × 0.35 m), at 1 ml/min He-flow rate (split = 20:1) with a Hewlett Packard 5971 Series mass selective detector (EI 70 eV) was used. And fast atom bombardment (FAB) mass spectrometry was measured by Dr. H. Nadig on a MAR 312. High resolution mass spectrometry was conducted by the Schürch group at the University of Bern on a LTQ Orbitrap XL.

IR-Spectroscopy: Spectra were recorded on a Fourier transform infrared spectrometer Shimadzu FTIR-8400S by which the compounds were measured through a Specac Golden Gate ATR sampling system.

Elementary analysis: The elemental analysis were performed by Mr. W. Kirsch on a Leco CHN-900 or by Mrs Sylvie Mittelheisser on a Vario Micro Cube.

Melting Point: Measurements of melting points were made with a SRS EZ-Melt MPA 120 or Büchi 530 instrument.

5.2 First generation preparation of 5,10-dimethyl-5,10-dihydroboranthrene

The following compound was prepared according to literature procedure: 1,2-Bis(trimethylsilyl)benzene (**191**)².

5,10-Dichloro-5,10-dihydroboranthrene (**189**)

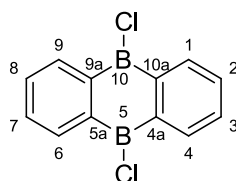

The thermolysis of the trimethylsilyl dichloroborylbenzene **188** (5.41 mmol, 1.25 g) at 135 °C for 18 h and consecutive sublimation at 150 °C/0.3 mbar gave white crystals (240 mg, 36%). In consequence of the air sensitivity of the product only NMR-spectroscopy was conducted.

¹H-NMR: (400 MHz, C₆D₆) δ 8.20 (dd, *J* = 3.3, 5.4 Hz, 4H, 1-H, 4-H, 6-H, 9-H), 7.17 (dd, *J* = 3.2, 5.5 Hz, 4H, 2-H, 3-H, 7-H, 8-H).

(400 MHz, CDCl₃) δ 8.35 – 8.28 (m, 4H), 7.73 – 7.67 (m, 4H).

¹³C-NMR: (101 MHz, C₆D₆) δ 136.6, 134.1 (4a, 5a, 9a, 10a not visible due to coupling with boron).

(101 MHz, CDCl₃) δ 136.7, 134.4 (4a, 5a, 9a, 10a not visible due to coupling with boron).

5,10-Dimethyl-5,10-dihydroboranthrene (**192**)

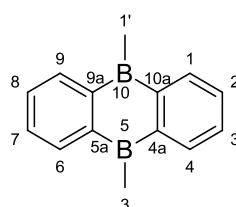

To a suspension of the dihydroboranthrene **189** (0.52 mmol, 128 mg) in THF (5 ml) was added 1.6M MeLi (1.04 mmol, 660 μl) in Et₂O for 10 min at –18 °C and after stirring for 1 h the reaction mixture turned to a colorless solution. The solution was warmed to r.t. and stirred

during 1 h, concentrated at r.t./20 – 0.02 mbar and sublimed at 150 °C/0.02 mbar to yield white colorless crystals (23.2 mg, 22%).

¹H-NMR: (400 MHz, C₆D₆) δ 8.01 (dd, *J* = 3.3, 5.4 Hz, 4H, 1-H, 4-H, 6-H, 9-H), 7.34 (dd, *J* = 3.3, 5.4 Hz, 4H, 2-H, 3-H, 7-H, 8-H), 1.32 (s, 6H, 1'-H, 1''-H).

The analytic data are in accordance with the literature.¹

5.3 Second generation preparation of 5,10-dimethyl-5,10-dihydroboranthrene

1,2-Bis(trimethylsilyl)benzene (191)

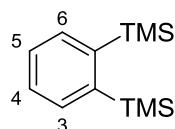

Method A: Pulverized Mg (3.04 g, 125 mmol, 2.50 equiv) was dried under vacuum at ~300 °C for 30 min. After cooling down and flushing with N₂, THF (50 ml) and 2 mol% of 1M DIBAL-H in THF (1.0 ml) were added and refluxed for five minutes. After the addition of TMSCl (13.9 g, 16.3 ml, 125 mmol, 2.50 equiv), 1,2-dibromobenzene (**190**) (11.8 g, 6.03 ml, 50.0 mmol, 1.00 equiv) was added drop wise within 45 min maintaining reflux. The mixture was stirred for additional 35 min. The reaction mixture was poured into a mixture of sat. NaHCO₃ (125 ml) and ice (60 ml). Et₂O (125 ml) was added and solids were filtered off. The aqueous phase was extracted with Et₂O (1 × 125 ml, 1 × 100 ml, 1 × 60 ml) and the combined extract was dried over Na₂SO₄ and evaporated under reduced pressure. The crude product was purified by distillation over a Vigreux-column at 1.1 mbar and 72 – 81 °C to give 4.08 g (37%) of clear oil.

Method B: Pulverized Mg (0.729 g, 30.0 mmol, 3.00 equiv) and anhydrous FeCl₃ (48.7 mg, 0.300 mmol, 3 mol%) were dried for 30 min under vacuum and heated to ~300 °C for 5 min. After cooling down and flushing with N₂, THF (10 ml), TMEDA (1.39 g, 1.81 ml, 12.0 mmol, 1.20 equiv) and 2 mol% of 1M DIBAL-H in THF (0.2 ml) were added and stirred for five minutes. Then, TMSCl (3.26 g, 3.83 ml, 30.0 mmol, 3.00 equiv) was added and cooled to -10 °C. 1,2-Dibromobenzene (**190**) (2.36 g, 1.21 ml, 10.0 mmol, 1.00 equiv) was added drop wise over six hours maintaining the temperature between -10 and 0 °C. The mixture was stirred for additional 18 h at -10 to 0 °C. Then, the reaction was poured into a mixture of sat. NaHCO₃

(25 ml) and ice (12 ml). Et₂O (25 ml) was added and solids were filtered off. The aqueous phase was extracted with Et₂O (1 × 25 ml, 1 × 20 ml, 1 × 12 ml) and the combined extract was dried over Na₂SO₄ and evaporated under reduced pressure. The crude product was purified by column chromatography over silica by hexane (+1% TEA) to yield a clear liquid (1.21 g). Volatile impurities were removed at high vacuum to give 0.909 g of clear oil in a 41% yield.

¹H-NMR: (400 MHz, C₆D₆) δ 7.67 (dd, *J* = 3.2 Hz, *J* = 2.4 Hz, 2H, 3-H, 6-H), 7.32 (dd, *J* = 3.2 Hz, *J* = 2.4 Hz, 2H, 4-H, 5-H), 0.36 (s, 18H, 7-H, 8-H, 9-H, 10-H, 11-H, 12-H).

The analytic data are in accordance with the literature.²

5,10-Dichloro-5,10-dihydroboranthrene (**189**)

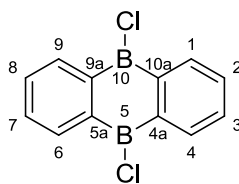

To BCl₃ (26.3 ml, 26.3 mmol, 1M in heptanes, 2.05 equiv) was added 1,2-dichloroethane (10 ml), 1,2-bis(trimethylsilyl)benzene (**191**) (2.84 g, 12.8 mmol, 1.00 equiv) and the mixture was stirred at 140 °C for 3 d. The reaction mixture was then cooled to 0 °C and decanted, washed two times with hexane (5 ml and 2.5 ml) and the precipitate was dried at high vacuum to yield white needles (944 mg, 60%). By additionally evaporating and sublimation of the filtrate a total yield of (70%) could be achieved.

¹H-NMR: (400 MHz, C₆D₆) δ 8.20 (m, 4H; 1-H, 4-H, 6-H, 9-H), 7.17 (m, 4H; 2-H, 3-H, 7-H, 8-H)

(400 MHz, CDCl₃) δ 8.35–8.28 (m, 4H), 7.73–7.67 (m, 4H).

¹³C-NMR: (101 MHz, C₆D₆) δ 136.6, 134.1 (4a, 5a, 9a, 10a not visible due to coupling with boron)

(101 MHz, CDCl₃) δ 136.7, 134.4 (4a, 5a, 9a, 10a not visible due to coupling with boron)

¹¹B-NMR: (CDCl₃, 57 MHz) δ 58.50.

5,10-Dimethyl-5,10-dihydroboranthrene (192)

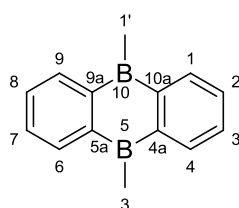

To a suspension of dichloro dihydroboranthrene **189** (516 mg, 2.11 mmol, 1.00 equiv) in hexane (15 ml) was added AlMe₃ (1.06 ml, 2.11 mmol, 2M in heptane, 1.00 equiv) within 5 min at –40 °C and stirred for 1 h before allowing to warm to rt and stirring for 19 h. Sublimation at 120 °C/0.2 mbar yielded white crystals (394 mg, 92%).

¹H-NMR: (400 MHz, C₆D₆) δ 8.01 (m, 4H; 1-H, 4-H, 6-H, 9-H), 7.34 (m, 4H; 2-H, 3-H, 7-H, 8-H), 1.32 (s, 6H; 1'-H, 1''-H).

The analytic data are in accordance with the literature.¹

5.4 Complexation experiment

Complex of 5,10-dimethyl-5,10-dihydroboranthrene with phthalazine (184)

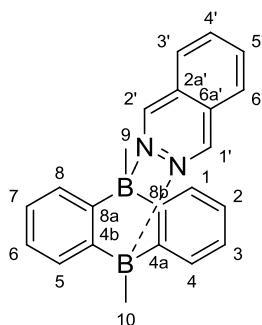

A 44mM solution of 5,10-dimethyl-5,10-dihydroboranthrene (**192**) in C_6D_6 (0.5 ml) was titrated stepwise with $10 \times 5 \mu\text{l}$ of a 0.44M solution of phthalazine **183** in C_6D_6 to precipitate a yellowish solid, monitored by $^1\text{H-NMR}$. The complex was dried by N_2 flow and dissolved in THF- d_8 (0.5 ml).

$^1\text{H-NMR}$: (400 MHz, THF- d_8) δ 9.89 (*s*, 2H, 1'-H, 2'-H), 8.35 (dd, $J = 3.2, 6.0$ Hz, 2H, 3'-H, 6'-H), 8.10 (dd, $J = 3.2, 6.0$ Hz, 2H, 4'-H, 5'-H), 7.35 (dd, $J = 3.2, 5.2$ Hz, 4H, 1-H, 4-H, 5-H, 8-H), 6.76 (dd, $J = 3.2, 5.2$ Hz, 4H, 2-H, 3-H, 6-H, 7-H), 1.05 (*s*, 6H, 9-H, 10-H).

5.5 Bidentate Lewis acid catalyzed IEDDA reaction

5.5.1 First catalysis of model reaction

2-Ethyl-3-methyl-4,5-dihydrooxazol-3-ium iodide (194)

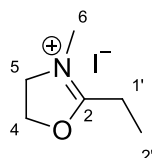

A solution of MeI (8.52 g, 3.73 ml, 60.0 mmol, 1.20 equiv) and 2-ethyl-2-oxazoline (**193**) (4.96 g, 50.0 mmol, 1.00 equiv) in CH₃CN was stirred at rt for 30 h. The reaction mixture was evaporated at 45 °C/15 mbar and dried at rt/0.3 mbar to yield a yellowish sticky solid (10.6 g, 88%). The product was very sensitive to air and therefore, it was directly used in the next reaction.

¹H-NMR: (400 MHz, CD₃CN) δ 4.85 (t, $J = 9.9$, 2H, 4-H), 4.08 (t, $J = 9.9$, 2H, 5-H), 3.25 (s, 3H, 1''-H), 2.76 (q, $J = 7.5$, 2H, 1'-H), 1.12 (t, $J = 7.5$, 3H, 2'-H).

2-Ethylidene-3-methyloxazolidine (195)

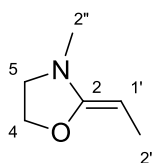

To a dispersion of dihydrooxazolium iodide **194** (4.00 g, 16.6 mmol, 1.00 equiv) in THF (20 ml) was added NaH (730 mg, 18.3 mmol, 60% in mineral oil, 1.10 equiv) at -18 °C within 1.5 h and stirred for 30 min. The mixture was warmed to rt and stirred for 3 h. The white suspension was filtered, concentrated at 50 °C/50 mbar and Kugelrohr distilled at 100 °C/15 mbar to obtain a yellowish clear liquid (973 mg, 52%), containing traces of THF. The product was very sensitive to air and handled only under nitrogen atmosphere.

¹H-NMR: (400 MHz, C₆D₆) δ 3.62 (t, *J* = 6.5, 2H, 4-H), 3.29 (q, *J* = 6.5, 1H, 1'-H), 2.45 (t, *J* = 6.5, 2H, 5-H), 2.24 (s, 3H, 1''-H), 1.97 (d, *J* = 6.6, 3H, 2'-H).

¹³C-NMR: (101 MHz, C₆D₆) δ 158.0, 64.8, 64.7, 52.0, 34.7, 10.3.

MS: (EI) *m/z* (%): 113 (M⁺, 70), 57 (100).

2-[Methyl(3-methylnaphthalen-2-yl)amino]ethanol (196)

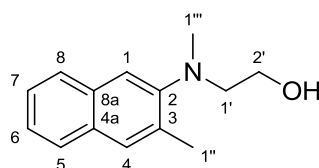

NMR-Experiments:

General procedure: A 44mM solution of 5,10-dimethyl-5,10-dihydroboranthrene (**192**) in benzene was added to phthalazine **183** (1.00 equiv). After concentrating with a nitrogen flow, diglyme (200 μl), followed by *Hünig's* base (50 μl) and oxazolidine **195** (1-1.5 equiv) were added and the reaction mixture was stirred at 120 °C for 12 h and analyzed by NMR-spectroscopy.

In parallel a reference reaction containing all the same except catalyst **192** was set up under the same conditions.

Reaction with 10 mol% of Catalyst: The catalyst **192** (100 μl, 4.4 μmol, 10 mol%), phthalazine **183** (5.7 mg, 44 μmol, 1.0 equiv) and oxazolidine **195** (5.0 mg, 44 μmol, 1.0 equiv) were stirred for 12 h and diluted with C₆D₆ (0.5 ml).

Reaction with 5 mol% of Catalyst: The catalyst **192** (50 μl, 2.2 μmol, 5.0 mol%), phthalazine **183** (5.7 mg, 44 μmol, 1.0 equiv) and oxazolidine **195** (7.5 mg, 66 μmol, 1.5 equiv) were stirred for 22 h and diluted with CDCl₃ (0.5 ml).

Reaction with 2.5 mol% of Catalyst: Catalyst **192** (25 μl, 1.1 μmol, 2.5 mol%), phthalazine **183** (5.7 mg, 44 μmol, 1.0 equiv) and oxazolidine **195** (7.5 mg, 66 μmol, 1.5 equiv) were stirred for 22 h and diluted with CDCl₃ (0.5 ml).

Reaction mixtures were evaluated by ¹H-NMR.

Preparative Procedure:

To a fine suspension of catalyst **192** (5.0 mg, 15.0 μmol , 5.00 mol%) and phthalazine (**183**) (39.0 mg, 0.300 mmol, 1.00 equiv) in diglyme (500 μl) and *N,N*-diisopropylethylamine (125 μl) was added 2-ethylidene-3-methyloxazolidine (**195**) (50.9 mg, 0.450 mmol, 1.50 equiv). The reaction mixture was heated to 120 $^{\circ}\text{C}$ for 20 h. After evaporation at 50 $^{\circ}\text{C}$ /2 mbar it was purified by flash chromatography (silica gel; hexane/ethylacetate 19:1 \rightarrow 4:1, stabilized with 1% Et_3N) to yield a colorless oil (28.4 mg, 42%).

TLC: R_f = 0.44 (EtOAc: cyclohexane, 1:1 with 1% Et_3N).

$^1\text{H-NMR}$: (400 MHz, CDCl_3) δ 7.73 – 7.70 (m, 2H, H-Ar), 7.64 (s, 1H, 4-H), 7.45 (s, 1H, 1-H), 7.41 – 7.33 (m, 2H, H-Ar), 3.76 (t, J = 5.5 Hz, 2H, 1'-H), 3.20 (t, J = 5.5 Hz, 2H, 2'-H), 2.76 (s, 3H, 1'''-H), 2.50 (bs, 1H, OH), 2.49 (s, 3H, 1''-H).

$^{13}\text{C-NMR}$: (101 MHz, CDCl_3) δ 150.99, 133.29, 132.98, 130.84, 129.68, 126.92, 126.87, 125.44, 124.91, 117.60, 59.22, 57.97, 42.38, 18.94.

MS: (EI) m/z (%): 215 (M^+ , 20), 184 (100).

IR: (ν/cm^{-1}): 3366 (w, $\nu_{\text{O-H}}$), 2948 (m), 2920 (w), 2885 (w), 2846 (w), 2794 (w), 1629 (m), 1589 (m), 1499 (s), 1486 (s), 1449 (m), 1418 (m), 1378 (s), 1336 (m), 1334 (s).

5.5.2 Enols as dienophiles

5.5.2.1 Preparation of the dienophile

2-Methylenetetrahydrofuran (197c):

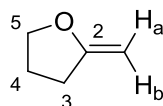

To a suspension of pre-dried KOH (2.83 g, 45.4 mmol, 90%, 1.50 equiv) in furfuryl alcohol (3 ml) was added 2-(bromomethyl)tetrahydrofuran (5.00 g, 30.3 mmol, 1.00 equiv) over 5 min. After cooling to rt the reaction was stirred for 17 h to obtain a thick suspension which was distilled at 70-75 °C/250 mbar to yield a colorless liquid containing water. Re-distillation at 60 °C/160 mbar over NaH (500 mg) gave a colorless liquid (1.08 g, 42%).

¹H-NMR: (400 MHz, C₆D₆) δ 4.56 (s, 1H, H_a), 3.92 (s, 1H, H_b), 3.64 (t, *J* = 6.7 Hz, 2H, 5-H), 2.10 (t, *J* = 7.6 Hz, 2H, 3-H), 1.35 – 1.26 (m, 2H, 4-H).

The analytic data are in accordance with the literature.³

5-Butyl-2,3-dihydrofuran (197d)

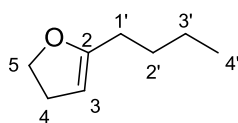

A solution of 1.9M *t*-BuLi in pentane (20.0 ml, 38.0 mmol, 1.20 equiv) was added dropwise over 10 min to a solution of 2,3-dihydrofuran (**197a**) (3.20 g, 45.7 mmol, 1.44 equiv) in dry tetrahydrofuran (15 ml) at ca. –60 °C. The resulting yellow suspension was slowly allowed to warm to 0 °C and was stirred for further 30 min. The mixture was then cooled to –30 °C and iodobutane (5.83 g, 3.62 ml, 31.7 mmol, 1.00 equiv) was added over 10 min. The mixture was slowly allowed to warm to rt and was stirred for 36 h. The white suspension obtained was poured into a mixture of saturated ammonium hydroxide solution (4 ml) and saturated ammonium chloride solution (36 ml) and the organic layer was extracted with ether (3 × 40 ml). The combined extracts were dried briefly (Na₂SO₄) and very carefully evaporated to

leave a yellow oil. Distillation over Vigreux at 44-45 °C/17 mbar yielded a colorless liquid (2.18 g, 55%).

¹H-NMR: (400 MHz, C₆D₆) δ 4.52 – 4.47 (m, 1H, 3-H), 4.09 (t, *J* = 9.3 Hz, 2H, 5-H), 2.39 – 2.30 (m, 2H, 1'-H), 2.15 – 2.08 (m, 2H, 4-H), 1.56 – 1.45 (m, 2H, 2'-H), 1.31 – 1.21 (m, 2H, 3'-H), 0.91 (t, *J* = 7.4 Hz, 3H, 4'-H).

The analytic data are in accordance with the literature.⁴

2-(Methylene)-1,3-dioxolane (197e)

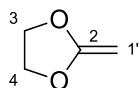

To bromomethyl dioxolane (2.30 g, 13.8 mmol, 1.00 equiv) in Et₂O (10 ml) was added NaH (828 mg, 20.7 mmol, 60% in mineral oil, 1.50 equiv) over 10 min at rt. The suspension was stirred for 17 h. Distillation (70 mbar/75 °C) yielded the desired product (632 mg, 53%).

¹H-NMR: (C₆D₆, 400 MHz) δ 3.56 (s, 2H, 1'-H), 3.31 (s, 4H, 4-H, 5-H).

The analytic data are in accordance with the literature.^{5,6}

5.5.2.2 Catalyzed IEDDA reactions

General procedure for furans and dioxolanes: To phthalazine **183** (0.440 mmol, 1.00 equiv) and catalyst **192** (7.3 mg, 22.0 μmol , 5.00 mol%) was added diglyme (0.45 ml), *Hünig's* base (75-150 μl) and dienophile (2.00-3.00 equiv). The mixture was stirred for the given time at the given temperature. After the addition of 1M HCl (5 ml) the reaction mixture was extracted (3×5 ml), dried over Na_2SO_4 , evaporated, diluted with CDCl_3 (0.75-1 ml), irradiated with UV light and distilled or purified by column chromatography.

2-(Naphthalen-2-yl)ethanol (**200a**)

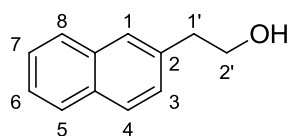

According to the general procedure the catalyst **192** (7.3 mg, 21.8 μmol , 5.00 mol%), phthalazine **183** (56.7 mg, 0.436 mmol, 1.00 equiv), diglyme (450 μl), *N,N*-diisopropylethylamine (150 μl) and dihydrofuran **197a** (0.871 mmol, 61.1 mg, 1.98 equiv) were stirred for 3 d at 170 $^\circ\text{C}$. After evaporation of the diglyme at 80 $^\circ\text{C}/10$ mbar, the residue was purified by over 20 g silicagel (1:4 EtOAc/hexanes) to obtain the naphthalene (32.6 mg, 43%).

$^1\text{H-NMR}$: (400 MHz, CDCl_3) δ 7.86 – 7.76 (m, 3H, 4-H, 5-H, 8-H), 7.70 (s, 1H, 1-H), 7.52 – 7.40 (m, 2H, 6-H, 7-H), 7.40 – 7.32 (dd, $J = 8.3, 1.4$ Hz, 1H, 3-H), 3.95 (t, $J = 6.0$ Hz, 2H, 3'-H), 3.04 (t, $J = 6.4$ Hz, 2H, 2'-H), 1.68 (s, 1H).

The analytic data are in accordance with the literature.⁷

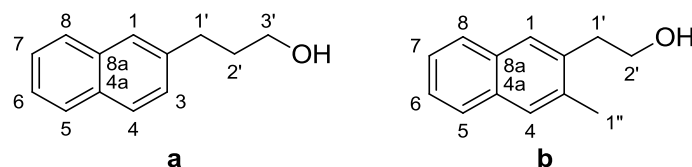
3-(Naphthalen-2-yl)propan-1-ol (**200ba**), 2-(3-Methylnaphthalen-2-yl)ethanol (**200bb**)

from 197b: According to the general procedure the phthalazine complex of catalyst **192** (7.3 mg, 21.8 μmol , 5.00 mol-%), phthalazine (**183**) (56.7 mg, 0.436 mmol, 1.00 equiv), diglyme (450 μl), *N,N*-diisopropylethylamine (150 μl) and dihydrofuran **197b** (73.3 mg, 0.872 mmol, 2.00 equiv) were stirred for 2 d at 160 °C to obtain (63.9 mg, 75 %) of the naphthalenes **200ba** and **200bb** in a 3:1 ratio after workup with hexane, 2.5 h irradiation and distillation at 190 °C/0.5 mbar.

From 197c: According to the general procedure the phthalazine complex of catalyst **192** (7.3 mg, 21.8 μmol , 5.00 mol-%), phthalazine (**183**) (56.7 mg, 0.436 mmol, 1.00 equiv), diglyme (450 μl), *N,N*-diisopropylethylamine (150 μl) and dihydrofuran **197c** (73.3 mg, 0.872 mmol, 2.00 equiv) were stirred for 2 d at 160 °C. After workup with CH_2Cl_2 , the residue was purified by chromatography over 15 g silica (1:4 EtOAc/Hex) to yield the naphthalenes **200ba** and **200bb** in a 4.5:1 ratio (55.5 mg, 65 %).

$^1\text{H-NMR}$: **a:** (400 MHz, CDCl_3) δ 7.88 – 7.75 (m, 2H, 5-H, 8-H), 7.66 (s, 2H, 1-H, 4-H), 7.53 – 7.43 (m, 2H, 6-H, 7-H), 7.37 (dd, $J = 8.4, 1.6$ Hz, 1H, 3-H), 3.70 (t, $J = 6.4$ Hz, 2H, 3'-H), 2.89 (t, $J = 8.0$ Hz, 2H, 1'-H), 1.99 (tt, $J = 13.0, 6.5$ Hz, 2H, 2'-H), 1.92 (s, 1H, O-H).

$^1\text{H-NMR}$: **b:** (400 MHz, CDCl_3) δ 7.88 – 7.75 (m, 2H, 5-H, 8-H), 7.66 (s, 2H, 1-H, 4-H), 7.53 – 7.43 (m, 2H, 6-H, 7-H), 3.94 (t, $J = 6.8$ Hz, 2H, 2'-H), 3.06 (t, $J = 6.8$ Hz, 2H, 1'-H), 2.51 (s, 3H, 1''-H), 1.92 (s, 1H, O-H).

$^{13}\text{C-NMR}$: (101 MHz, CDCl_3) δ 139.80, 135.82, 135.42, 134.08, 133.04, 132.69, 132.47, 128.80, 128.41, 128.35, 128.07, 127.87, 127.74, 127.56, 127.32, 126.88, 126.40, 125.96, 125.70, 125.64, 62.95, 62.61, 36.99, 34.50, 32.64, 20.39.

MS: (EI) m/z (%): 186 (M^+ , 33), 142 (100).

HRMS: (ESI) m/z calcd for $[\text{C}_{13}\text{H}_{15}\text{O}]^+$: $[\text{M}+\text{H}]^+$ 187.1117; found 187.1124.

The analytic data are in accordance with the literature.⁷

2-(3-Butylnaphthalen-2-yl)ethanol (**200ca**), 3-(3-Propylnaphthalen-2-yl)propan-1-ol (**200cb**)

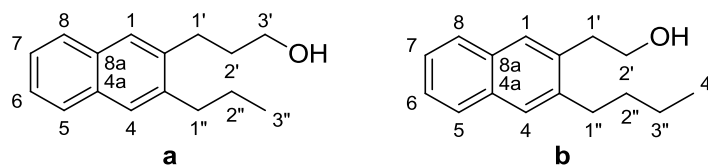

According to the general procedure the phthalazine complex of catalyst **192** (7.3 mg, 21.8 μmol , 5.00 mol%), phthalazine (**183**) (56.7 mg, 0.436 mmol, 1.00 equiv), diglyme (450 μl), *N,N*-diisopropylethylamine (75 μl) and dihydrofuran **197d** (111 mg, 0.880 mmol, 2.02 equiv) were stirred for 2 d at 160 $^{\circ}\text{C}$ to obtain (72.7 mg, 73 %) of the naphthalenes **200da** and **200db** in a 1.5:1 ratio after workup, 3.5 h irradiation and distillation at 200 $^{\circ}\text{C}/0.5$ mbar.

$^1\text{H-NMR}$: **a:** (400 MHz, CDCl_3) δ 7.78–7.71 (m, 2H; 5-H, 8-H), 7.68 (s, 1H; 1-H*, 4-H*), 7.67 (s, 1H; 1-H*, 4-H*), 7.43–7.35 (m, 2H; 6-H, 7-H), 3.77 (t, $J=6.4$ Hz, 2H; 3'-H), 2.94–2.83 (t, $J=7.7$ Hz, 2H; 1''-H), 2.81–2.72 (t, $J=7.7$ Hz, 2H; 1''-H), 1.97 (dq, $J=14.2, 6.4$ Hz, 2H; 2''-H), 1.73 (dd, $J=15.3, 7.6$ Hz, 2H; 2''-H), 1.04 (t, $J=7.3$ Hz, 3H; 3''-H).

$^1\text{H-NMR}$: **b:** (400 MHz, CDCl_3) δ 7.84–7.72 (m, 2H; 5-H, 8-H), 7.65 (s, 2H; 1-H, 4-H), 7.49–7.37 (m, 2H; 6-H, 7-H), 3.94 (t, $J=6.8$ Hz, 2H; 2'-H), 3.08 (t, $J=6.8$ Hz, 2H; 1'-H), 2.85–2.75 (t, $J=6.6$ Hz, 2H; 1''-H), 1.76–1.66 (m, 2H; 2''-H), 1.55–1.44 (m, 2H; 3''-H), 0.98 (t, $J=7.3$ Hz, 3H; 4''-H).

$^{13}\text{C-NMR}$: (101 MHz, CDCl_3) δ 140.04, 139.66, 138.94, 135.21, 132.99, 132.69, 132.59, 132.46, 128.53, 127.90, 127.60, 127.47, 127.45, 127.43 (2C), 127.40, 125.87, 125.67, 125.55, 125.51, 63.59, 63.00, 36.34, 35.31, 34.20, 33.71, 33.12, 29.36, 24.53, 23.21, 14.64, 14.46.

MS: (EI, 70 eV) m/z (%): 228 (54) [M^+], 155 (100).

HRMS: (ESI): m/z calcd for $[\text{C}_{16}\text{H}_{21}\text{O}]^+$: [$\text{M}+\text{H}^+$] 229.1587; found: 229.1592.

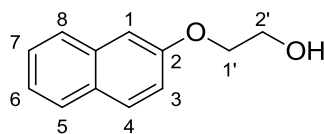
2-(Naphthalen-2-yloxy)ethanol (**200d**)

According to the general procedure the catalyst **192** (6.0 mg, 18.0 μmol , 5.00 mol%), phthalazine **183** (46.8 mg, 359 μmol , 1.00 equiv), solvent (450 μl), *N,N*-diisopropylethylamine (150 μl) and dioxolane **197e** (61.9 mg, 718 μmol , 2.00 equiv) were stirred for 10h at 160 °C. After evaporation of the solvent, the residue was purified by chromatography over 15 g silica (2:3 TBME/hexane) to yield yellow crystals (31.8 mg, 45%).

¹H-NMR: (400 MHz, CDCl_3) δ 7.79 – 7.73 (m, 3H, Ar-H), 7.48 – 7.42 (m, 1H, Ar-H), 7.38 – 7.33 (m, 1H, Ar-H), 7.21-7.13 (m, 2H, Ar-H), 4.24 – 4.16 (m, 2H, 1'-H), 4.03 (dd, $J = 9.4, 5.2$ Hz, 2'-H), 2.16 (s, 1H, O-H).

The analytic data are in accordance with the literature.⁸

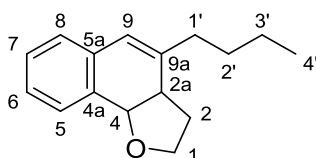
 9a-butyl-2,3,3a,9a-tetrahydronaphtho[2,3-b]furan (**199'**)

According to the general procedure the phthalazine complex of catalyst **192** (7.3 mg, 21.8 μmol , 5.00 mol%), phthalazine (**183**) (56.7 mg, 0.436 mmol, 1.00 equiv), diglyme (450 μl), and dihydrofuran **197d** (111 mg, 0.880 mmol, 2.02 equiv) were stirred for 2 d at 160 °C to obtain (17.8 mg, 18 %) of the tetrahydronaphthalene **199'** after workup, and chromatography over preparative TLC (1:19 TBME/hexane).

¹H-NMR: (400 MHz, CDCl_3) δ 7.45 – 7.41 (m, 1H, Ar-H), 7.25 – 7.16 (m, 2H, Ar-H), 7.03 (dd, $J = 7.1, 1.7$ Hz, 1H, Ar-H), 6.17 (s, 1H, 9-H), 5.09 (d, $J = 8.1$ Hz, 1H, 4-H), 3.83 (dd, $J = 15.4, 7.4$ Hz, 1H, 1-H), 3.75 (td, $J = 8.0, 5.1$ Hz, 1H, 1-H), 2.93 (q, $J = 8.1$ Hz, 1H, 2a-H), 2.35 (dddd, $J = 12.2, 8.4, 7.4, 5.1$ Hz, 1H, 2-H),

2.22 (q, $J = 7.8$ Hz, 2H, 1'-H), 1.88 (dq, $J = 12.2, 7.6$ Hz, 1H, 2-H), 1.64 – 1.45 (m, 2H, 2'-H), 1.44 – 1.29 (m, 2H, 3'-H), 0.98 – 0.92 (m, 3H, 4'-H).

$^{13}\text{C-NMR}$: (127 MHz, CDCl_3) δ 141.03, 132.97, 132.36, 128.18, 128.04, 126.92, 126.10, 121.05, 77.82, 65.80, 41.65, 35.38, 32.55, 29.83, 22.57, 14.06.

MS: (EI) m/z (%): 228 (M^+ , 88)

HRMS: (ESI) m/z calcd for $[\text{C}_{16}\text{H}_{20}\text{ONa}]^+$: $[\text{M}+\text{Na}]^+$ 251.1406; found 240.1401.

5.5.3 Enamines from ketones as dienophiles

The following compounds were prepared according to literature procedures or obtained from Sigma-Aldrich: 1-Cyclohexenylpyrrolidine (**203b**)³

General procedure for enamines from ketones: To phthalazine (**183**) (57.2 mg, 0.440 mmol, 1.00 equiv) and catalyst **192** (4.5 mg, 22.0 μ mol, 5 mol-%) was added diglyme (0.45 ml), enamine (3.00 equiv) or ketone and pyrrolidine (2.00 equiv). The mixture was stirred for the given time at the given temperature. To the mixture at -78 °C was added *m*CPBA (1.50-5.00 equiv) and then it was left at room temperature over night. After the addition of H₂O (5 ml) the reaction mixture was extracted with cyclohexane (3 \times 5 ml), re-extracted with 1M NaOH, dried over Na₂SO₄, evaporated and purified by column chromatography.

2,3-Dihydro-1H-cyclopenta[b]naphthalene (**200e**)

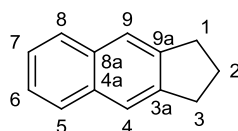

According to the general procedure the catalyst **192** (4.5 mg, 22.0 μ mol, 5.00 mol-%), phthalazine (**183**) (57.5 mg, 441 μ mol, 1.00 equiv), solvent (450 μ l), cyclopentanone (61.9 mg, 718 μ mol, 2.00 equiv) and pyrrolidine (62.8 mg, 883 μ mol, 2.00 equiv) were stirred for 2.5 d at 55 °C and treated with *m*CPBA (495 mg, 2.21 mmol, 77%, 5.00 equiv). After workup, the residue was purified by chromatography over 10 g silica (cyclohexane) to yield white crystals (38.5 mg, 52%).

¹H-NMR: (400 MHz, CDCl₃) δ 7.81–7.76 (m, 2H; 5-H, 8-H), 7.68 (s, 2H; 4-H, 9-H), 7.44–7.37 (m, 2H; 6-H, 7-H), 3.13–3.03 (m, 4H; 1-H, 3-H), 2.22–2.12 (m, 2H; 2-H).

The analytic data are in accordance with the literature.⁹

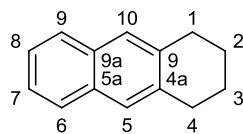
1,2,3,4-Tetrahydroanthracene (200f)

According to the general procedure the catalyst **192** (4.5 mg, 22.0 μmol , 5.00 mol-%), phthalazine (**183**) (57.5 mg, 441 μmol , 1.00 equiv), solvent (450 μl), 1-cyclohexenylpyrrolidine (**203b**) (200 mg, 1.32 mmol, 3.00 equiv) were stirred for 2.5 d at 90 $^{\circ}\text{C}$ and treated with *m*CPBA (297 mg, 1.32 mmol, 77%, 3.00 equiv). After workup, the residue was purified by chromatography over 10 g silica (hexane) to yield white crystals (64.5 mg, 80%).

$^1\text{H-NMR}$: (400 MHz, CDCl_3) δ 7.76–7.68 (m, 2H; 6-H, 9-H), 7.55 (s, 2H; 5-H, 10-H), 7.41–7.33 (m, 2H; 7-H, 8-H), 2.98 (s, 4H; 1-H, 4-H), 1.96–1.81 (m, 4H; 2-H, 3-H).

The analytic data are in accordance with the literature.⁹

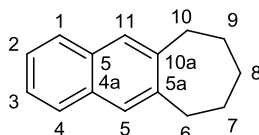
7,8,9,10-Tetrahydro-6H-cyclohepta[b]naphthalene (200g)

According to the general procedure the catalyst **192** (4.5 mg, 22.0 μmol , 5.00 mol-%), phthalazine (**183**) (57.5 mg, 441 μmol , 1.00 equiv), solvent (450 μl), cycloheptanone (99.0 mg, 883 μmol , 2.00 equiv) and pyrrolidine (47.1 mg, 662 μmol , 2.00 equiv) were stirred for 2.5 d at 80 $^{\circ}\text{C}$ and treated with *m*CPBA (297 mg, 1.32 mmol, 77%, 3.00 equiv). After workup, the residue was purified by chromatography over 10 g silica (cyclohexane) to yield white crystals (73.9 mg, 85%).

¹H-NMR: (400 MHz, CDCl₃) δ 7.84–7.74 (m, 2H; 1-H, 4-H), 7.63 (s, 2H; 5-H, 11-H), 7.50–7.39 (m, 2H; 2-H, 3-H), 3.08–2.94 (m, 4H; 6-H, 10-H), 2.00–1.85 (m, 2H; 8-H), 1.85–1.68 (m, 4H; 7-H, 9-H).

The analytic data are in accordance with the literature.¹⁰

2-Ethyl-3-methylnaphthalene (200h)

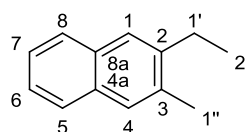

According to the general procedure the catalyst **192** (4.5 mg, 22.0 μmol, 5.00 mol-%), phthalazine (**183**) (57.5 mg, 441 μmol, 1.00 equiv), solvent (450 μl), 3-pentanone (97 mg, 1.10 mmol, 2.50 equiv) and pyrrolidine (62.8 mg, 883 μmol, 2.00 equiv) were stirred for 2.5 d at 130 °C and treated with *m*CPBA (198 mg, 882 μmol, 77%, 2.00 equiv). After workup, the residue was purified by chromatography over 10 g silica (cyclohexane) to yield white crystals (19.1 mg, 25%).

¹H-NMR: (400 MHz, CDCl₃) δ 7.81–7.70 (m, 2H; 5-H, 8-H), 7.61 (s, 2H; 1-H, 4-H), 7.43–7.36 (m, 2H; 6-H, 7-H), 2.80 (q, *J*=7.5 Hz, 2H; 1'-H), 2.48 (s, 3H; 1''-H), 1.33 (t, *J*=7.5 Hz, 3H; 2'-H).

The analytic data are in accordance with the literature.¹¹

11H-Benzo[b]fluorene (200i)

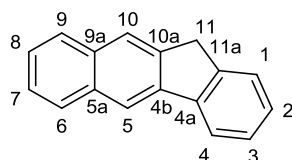

from 203e: According to the general procedure the catalyst **192** (4.5 mg, 22.0 μmol, 5.00 mol-%), phthalazine (**183**) (57.5 mg, 441 μmol, 1.00 equiv), solvent (450 μl), 1-indanone (117 mg, 882 μmol, 2.00 equiv) and pyrrolidine (62.8 mg, 882 μmol, 2.00 equiv) were stirred

for 14 h at 100 °C and treated with *m*CPBA (198 mg, 882 μmol, 77%, 2.00 equiv). After workup, the residue was purified by chromatography over 15 g silica (cyclohexane) to yield white crystals (37 mg, 39%).

From 203f: According to the general procedure the catalyst **192** (4.5 mg, 22.0 μmol, 5.00 mol-%), phthalazine (**183**) (57.5 mg, 441 μmol, 1.00 equiv), solvent (450 μl), 2-indanone (117 mg, 882 μmol, 2.00 equiv) and pyrrolidine (94.2 mg, 1.32 mmol, 2.50 equiv) were stirred for 2.5 d at 110 °C and treated with *m*CPBA (297 mg, 1.32 mmol, 77%, 3.00 equiv). After workup, the residue was purified by chromatography over 15 g silica (cyclohexane) to yield white crystals (25.9 mg, 26%).

¹H-NMR: (400 MHz, CDCl₃) δ 8.21 (s, 1H; 5-H), 8.03–7.85 (m, 4H), 7.85 (d, *J*=7.4, 1H), 7.51–7.33 (m, 4H), 4.09 (s, 2H; 11-H).

¹³C-NMR: (400 MHz, CDCl₃) δ 144.19, 141.63, 141.54, 140.95, 133.52, 133.44, 128.58, 128.22, 127.97, 127.39, 125.80, 125.75, 125.70, 123.78, 121.02, 118.21, 36.83.

The analytic data are in accordance with the literature.¹²

1-(2,3,3a,4-Tetrahydro-1H-cyclopenta[b]naphthalen-3a-yl)pyrrolidine (204)

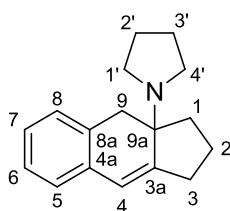

According to the general procedure the catalyst **192** (4.5 mg, 22.0 μmol, 5.00 mol-%), phthalazine (**183**) (57.5 mg, 441 μmol, 1.00 equiv), solvent (450 μl), cyclopentanone (61.9 mg, 718 μmol, 2.00 equiv) and pyrrolidine (62.8 mg, 883 μmol, 2.00 equiv) were stirred for 2.5 d at 50 °C. After workup, the residue was purified by chromatography over 10 g silica (1:9 EtOAc/cyclohexane) to yield white crystals (91.1 mg, 86%).

¹H-NMR: (400 MHz, CDCl₃) δ 7.57 (s, 1 H), 7.22 – 7.07 (m, 2 H), 7.07 – 6.90 (m, 1 H), 6.26 (s, 1 H), 3.99 (d, *J* = 13.3 Hz, 1 H), 2.96 (s, 2 H), 2.89 – 2.65 (m, 3 H),

2.55 (dd, $J = 17.9, 7.9$ Hz, 1 H), 2.48 – 2.32 (m, 1 H), 2.31 – 2.12 (m, 1 H), 2.02 – 1.75 (m, 5 H), 1.63 – 1.42 (m, 2 H).

$^{13}\text{C-NMR}$: (101 MHz, CDCl_3) δ 136.83, 126.89, 126.52, 125.87, 125.63, 118.75, 63.41, 48.30 (2 C), 43.13, 34.20, 30.45, 25.26, 24.54 (2 C).

MS: (EI, 70 eV) m/z (%): 239 (M^+ , 50).

HRMS: (ESI) m/z calcd for $[\text{C}_{17}\text{H}_{22}\text{N}]^+$: $[\text{M}+\text{H}]^+$ 240.1747; found 240.1755.

5.5.4 *N,O*-Ketene acetal in the catalyzed IEDDA reaction

5.5.4.1 Preparation of the dienophile

6-Ethoxy-1-methyl-1,2,3,4-tetrahydropyridine (206g)

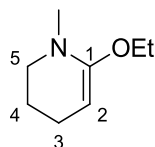

A suspension of $\text{Et}_3\text{O}^+\text{BF}_4^-$ (18.6 mmol, 3.53 g) and 1-methylpiperidin-2-one (17.7 mmol, 2.00 g) was stirred at rt for 16 h. The brownish suspension was treated with NaH (22.1 mmol, 884 mg, 60%) at rt and stirred for 5 h. The solvent was removed and the residue distilled at 50 °C/10 mbar to yield a colorless liquid 1.85 g (75%).

$^1\text{H-NMR}$: (400 MHz, CDCl_3) δ 3.78 (t, $J = 3.8$ Hz, 1H, 2-H), 3.58 (q, $J = 7.0$ Hz, 2H, OCH_2), 2.88 – 2.78 (m, 2H, 5-H), 2.60 (s, 3H, NCH_3), 2.13 (td, $J = 6.3, 3.8$ Hz, 3H, 3-H), 1.69 – 1.55 (m, 2H, 4-H), 1.08 (t, $J = 7.0$ Hz, 3H, OCH_2CH_3).

$^{13}\text{C-NMR}$: (400 MHz, CDCl_3) δ 157.01, 72.97, 62.66, 51.96, 37.89, 22.88, 22.04, 14.96.

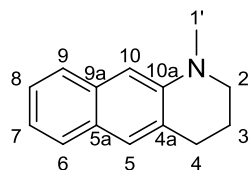
1-Methyl-1,2,3,4-tetrahydrobenzo[g]quinoline (200j)

Phthalazine (**183**) (57.5 mg, 0.441 mmol), the catalyst **192** (4.5 mg, 22.0 μmol , 5.00 mol%), 6-ethoxy-1-methyl-1,2,3,4-tetrahydropyridine (**206**) (125 mg, 0.883 mmol) have been stirred in diglyme (0.50 ml) for 14 h at 80 °C. The reaction mixture was purified over silica (1:19 EtOAc/cyclohexane +1% TEA) to obtain the product (87 mg, quant.).

$^1\text{H-NMR}$: (400 MHz, CDCl_3) δ 7.69–7.61 (m, 2H; 6-H, 9-H), 7.44 (s, 1H; 10-H), 7.38–7.32 (m, 1H; 8-H), 7.23–7.17 (m, 1H; 7-H), 6.82 (s, 1H; 5-H), 3.37 (t, $J=5.9$ Hz, 2H; 2-H), 3.05 (s, 3H; 1'-H), 2.98 (t, $J=6.3$ Hz, 2H; 4-H), 2.11–2.02 (m, 2H; 3-H).

$^{13}\text{C-NMR}$: (101 MHz, CDCl_3) δ 145.71, 134.84, 127.24 (2C), 127.03, 126.79, 126.01, 125.76, 121.98, 104.29, 51.66, 39.59, 28.94, 23.05.

MS: (EI, 70 eV) m/z (%): 197 (100) [M^+].

HRMS: (ESI) m/z calcd for [$\text{C}_{14}\text{H}_{16}\text{N}$] $^+$: [$\text{M}+\text{H}^+$] 198.1277; found: 198.1276.

5.5.5 Enamines from aldehydes as dienophiles

General procedure for enamines from aldehydes: Phthalazine (**183**) (40.0 mg, 0.307 mmol, 1.00 equiv) with catalyst **192** (3.13 mg, 0.0154 mmol, 5.00 mol %/1.57 mg, 0.0077 mmol, 2.50 mol %) was dissolved in THF (0.5 ml) and stirred. The aldehyde (0.768 mmol, 2.50 equiv) and pyrrolidine (26.2 mg, 0.369 mmol, 1.20 equiv) were added. In most cases immediate N₂ formation at rt was observed. The reaction was stirred at 60 °C for 20 h; the NMR analysis showed total conversion of the phthalazine (**183**). The solvent was removed under reduced pressure and purified by flash column chromatography to give the pure product.

2-Methylnaphthalene (**211a**)

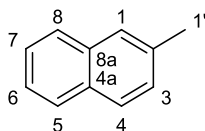

According to the general procedure phthalazine (**183**) (57.5 mg, 441 μmol, 1.00 equiv), catalyst **192** (1.57 mg, 0.0077 mmol, 2.50 mol %), solvent (0.5 ml), aldehyde **210a** and pyrrolidine (26.2 mg, 0.369 mmol, 1.20 equiv) were stirred for 20 h at 60 °C to yield colorless oil 13.1 mg (30%).

¹H-NMR: (400 MHz, CDCl₃) δ 7.83 (d, *J* = 8.0 Hz, 1 H), 7.65 (s, 1H), 7.81 – 7.75 (m, 2H), 7.52 – 7.40 (m, 2H), 7.35 (dd, *J* = 8.3, 0.9 Hz, 1H), 2.55 (s, 3H).

¹³C-NMR: (126 MHz, CDCl₃) δ 135.5, 133.7, 131.7, 128.1, 127.7, 127.6, 127.2, 126.9, 125.9, 125.0, 21.8.

MS: (EI): *m/z* (%) = 142 (100) [M]⁺.

The analytic data are in accordance with the literature.¹³

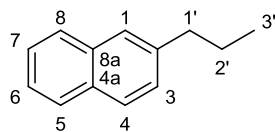
2-*n*-Propylnaphthalene (211b)

According to the general procedure phthalazine (**183**) (57.5 mg, 441 μmol , 1.00 equiv), catalyst **192** (1.57 mg, 0.0077 mmol, 2.50 mol %), solvent (0.5 ml), aldehyde **210b** and pyrrolidine (26.2 mg, 0.369 mmol, 1.20 equiv) were stirred for 20 h at 60 °C to yield colorless oil 6.0 mg (12%).

$^1\text{H-NMR}$: (400 MHz, CDCl_3) δ 7.84 – 7.75 (m, 3H), 7.61(s, 1H), 7.49 – 7.38 (m, 2H), 7.36 – 7.32 (m, 1H), 2.87 – 2.63 (m, 2H), 1.89 – 1.65 (m, 2H), 0.98 (t, $J = 7.3$ Hz, 3H).

$^{13}\text{C-NMR}$: (126 MHz, CDCl_3) δ 140.3, 133.8, 132.1, 127.8, 127.7, 127.6, 127.5, 126.5, 125.9, 125.1, 38.3, 24.6, 14.0.

MS: (EI): m/z (%) = 170 (30) $[\text{M}]^+$, 141 (100).

The analytic data are in accordance with the literature.¹⁴

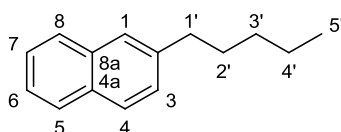
2-*n*-Pentylnaphthalene (211c)

According to the general procedure phthalazine (**183**) (57.5 mg, 441 μmol , 1.00 equiv), catalyst **192** (1.57 mg, 0.0077 mmol, 2.50 mol %), solvent (0.5 ml), aldehyde **210c** and methylethylenediamine (26.2 mg, 0.369 mmol, 1.20 equiv) were stirred for 20 h at 60 °C to yield colorless oil 18.0 mg (30%).

¹H-NMR: (400 MHz, CDCl₃) δ 7.85 – 7.73 (m, 3H), 7.62 (s, 1H), 7.51 – 7.38 (m, 2H), 7.35 (dd, *J* = 8.4, 1.7 Hz, 1H), 2.78 (t, *J* = 7.5 Hz, 2H), 1.79 – 1.64 (m, 2H), 1.42 – 1.34 (m, 4H), 0.95 – 0.87 (m, 3H).

¹³C-NMR: (126 MHz, CDCl₃) δ 140.5, 133.7, 131.9, 127.7, 127.6, 127.5, 127.4, 126.3, 125.8, 125.0, 36.1, 31.6, 31.1, 22.6, 14.1.

MS: (EI): *m/z* (%) = 198 (26) [M]⁺, 141 (100).

2-iso-Propylnaphthalene (211d)

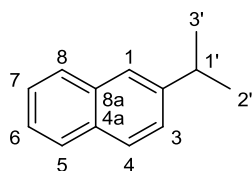

According to the general procedure phthalazine (**183**) (57.5 mg, 441 μmol, 1.00 equiv), catalyst **192** (1.57 mg, 0.0077 mmol, 2.50 mol %), solvent (0.5 ml), aldehyde **210d** and pyrrolidine (26.2 mg, 0.369 mmol, 1.20 equiv) were stirred for 20 h at 60 °C to yield colorless oil 22.8 mg (44%).

¹H-NMR: (400 MHz, CDCl₃) δ 7.84 – 7.77 (m, 3H), 7.66 (s, 1H), 7.48 – 7.38 (m, 3H), 3.13 – 3.04 (m, 9 Hz, 1H), 1.36 (d, *J* = 7.0 Hz, 6H).

¹³C-NMR: (126 MHz, CDCl₃) δ 146.5, 133.8, 132.2, 128.0, 127.7, 127.7, 125.9, 125.9, 125.2, 124.2, 34.4, 24.1 (2 C).

MS: (EI): *m/z* (%) = 170 (31) [M]⁺, 155 (100).

The analytic data are in accordance with the literature.¹⁵

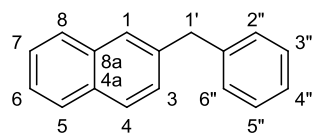
2-Benzyl n aphthalene (**211e**)

According to the general procedure phthalazine (**183**) (57.5 mg, 441 μ mol, 1.00 equiv), catalyst **192** (1.57 mg, 0.0077 mmol, 2.50 mol %), solvent (0.5 ml), aldehyde **210e** and pyrrolidine (26.2 mg, 0.369 mmol, 1.20 equiv) were stirred for 20 h at 60 °C to yield colorless oil 6.2 mg (9%).

$^1\text{H-NMR}$: (400 MHz, CDCl_3) δ 7.86 – 7.70 (m, 3H), 7.64 (s, 1H), 7.48 – 7.40 (m, 2H), 7.34 – 7.28 (m, 3H), 7.25 – 7.20 (m, 3H), 4.16 (s, 2H).

$^{13}\text{C-NMR}$: (126 MHz, CDCl_3) δ 141.1, 138.7, 133.7, 132.2, 129.2, 128.6 (2 C), 128.2, 127.78, 127.76, 127.7, 127.2, 126.3, 126.1, 125.5 (2 C), 42.3.

MS: (EI) m/z (%) = 218 (100) $[\text{M}]^+$.

The analytic data are in accordance with the literature.¹⁶

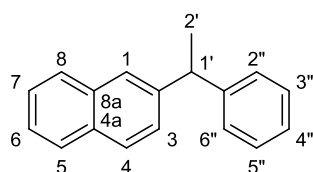
 2-(1-Phenylethyl) n aphthalene (**211f**)

According to the general procedure phthalazine (**183**) (57.5 mg, 441 μ mol, 1.00 equiv), catalyst **192** (3.13 mg, 0.0154 mmol, 5.00 mol %), solvent (0.5 ml), aldehyde **210f** and pyrrolidine (26.2 mg, 0.369 mmol, 1.20 equiv) were stirred for 20 h at 60 °C to yield yellow oil 45.9 mg (64%).

¹H-NMR: (400 MHz, CDCl₃) δ 7.86 – 7.78 (m, 2H), 7.75 (d, *J* = 8.5 Hz, 1H), 7.71 (s, 1H), 7.50 – 7.40 (m, 2H), 7.36 – 7.26 (m, 5H), 7.24 – 7.16 (m, 1H), 4.33 (q, *J* = 7.2 Hz, 1H), 1.75 (d, *J* = 7.2 Hz, 3H).

¹³C-NMR: (126 MHz, CDCl₃) δ 146.4, 143.9, 133.8, 132.3, 128.5 (2 C), 128.1, 127.90 (2 C), 127.86, 127.7, 127.0, 126.2, 126.1, 125.5 (2 C), 45.0, 21.9.

MS: (EI): *m/z* (%)=232 (49) [M]⁺, 217 (100).

The analytic data are in accordance with the literature.¹⁴

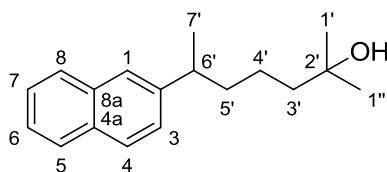
2-Methyl-6-(naphthalen-2-yl)heptan-2-ol (211g)

According to the general procedure phthalazine (**183**) (57.5 mg, 441 μmol , 1.00 equiv), catalyst **192** (3.13 mg, 0.0154 mmol, 5.00 mol %), solvent (0.5 ml), aldehyde **210g** and pyrrolidine (26.2 mg, 0.369 mmol, 1.20 equiv) were stirred for 20 h at 60 °C to yield colorless oil 46.3 mg (59%).

$^1\text{H-NMR}$: (400 MHz, CDCl_3) δ 7.80 (t, $J = 8.8$ Hz, 3H), 7.61 (d, $J = 0.8$ Hz, 1H), 7.48 – 7.40 (m, 2H), 7.35 (dd, $J = 8.5, 1.8$ Hz, 1H), 2.94 – 2.83 (m, 1H), 1.76 – 1.60 (m, 2H), 1.54 – 1.40 (m, 2H), 1.33 – 1.21 (m, 6H), 1.15 (s, 6H).

$^{13}\text{C-NMR}$: (126 MHz, CDCl_3) δ 145.2, 133.8, 132.3, 128.1, 127.71, 127.68, 125.93, 125.89, 125.3, 125.2, 71.1, 44.1, 40.2, 38.9, 29.4, 29.3, 22.6, 22.5.

MS: (EI): m/z (%) = 256 (14) $[\text{M}]^+$, 155 (100).

HRMS: (EI) calcd for $[\text{C}_{18}\text{H}_{24}\text{O}]^+$: $[\text{M}]^+$ 256.1827 found; 256.1823.

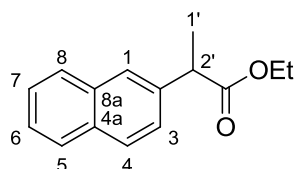
Ethyl 2-(naphthalen-2-yl)propanoate (211h)

According to the general procedure phthalazine (**183**) (57.5 mg, 441 μmol , 1.00 equiv), catalyst **192** (1.57 mg, 0.0077 mmol, 2.50 mol %), solvent (0.5 ml), aldehyde **210h** and pyrrolidine (26.2 mg, 0.369 mmol, 1.20 equiv) were stirred for 20 h at 60 °C to yield yellow oil 29.0 mg (41%).

¹H-NMR: (400 MHz, CDCl₃) δ 7.89 – 7.81 (m, 3H), 7.77 (s, 1H), 7.54 – 7.44 (m, 3H), 4.24 – 4.09 (m, 2H), 3.91 (q, *J* = 7.1 Hz, 1H), 1.62 (d, *J* = 7.2 Hz, 3H), 1.23 (t, *J* = 7.1 Hz, 3H).

¹³C-NMR: (126 MHz, CDCl₃) δ 174.6, 138.2, 133.5, 132.6, 128.3, 127.8, 127.6, 126.1, 126.1, 125.8 (2 C), 60.8, 45.7, 18.6, 14.2.

MS: (EI) *m/z* (%) = 228 (22) [M]⁺, 155 (100).

HRMS (ESI) *m/z* calcd for [C₁₅H₁₆O₂]⁺: [M + H]⁺ 229.1223; found: 229.1224.

2-Methyl-5-(1-(naphthalen-2-yl)ethyl)furan (211i)

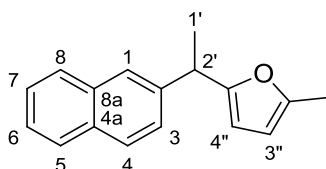

According to the general procedure phthalazine (**183**) (57.5 mg, 441 μmol, 1.00 equiv), catalyst **192** (3.13 mg, 0.0154 mmol, 5.00 mol %), solvent (0.5 ml), aldehyde **210i** and pyrrolidine (26.2 mg, 0.369 mmol, 1.20 equiv) were stirred for 20 h at 60 °C to yield yellow oil 7.8 mg (11%).

¹H-NMR: (500 MHz, CDCl₃) δ 7.86 – 7.77 (m, 3H), 7.68 (d, *J* = 0.9 Hz, 1H), 7.51 – 7.41 (m, 2H), 7.39 (dd, *J* = 8.4, 1.8 Hz, 1H), 5.98 (dd, *J* = 3.0, 0.5 Hz, 1H), 5.92 – 5.89 (m, 1H), 4.26 (q, *J* = 7.2 Hz, 1H), 2.25 (s, 3H), 1.67 (d, *J* = 7.2 Hz, 3H).

¹³C-NMR: (126 MHz, CDCl₃) δ 157.2, 151.1, 142.1, 133.7, 132.5, 128.2, 127.9, 127.7, 126.2, 126.0, 125.7, 125.5, 105.9, 105.9, 39.5, 20.7, 13.7.

MS: (EI) *m/z* (%) = 236 (28) [M]⁺, 221 (100).

HRMS: (ESI) *m/z* calcd for [C₁₇H₁₆O]⁺: [M]⁺ 236.1201; found: 236.1198

5.5.6 Substituted 1,2-diazines as dienes

4,9-Dichloro-2,3-dihydro-1H-cyclopenta[*b*]naphthalene (**217a**)

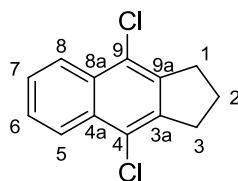

According to the general procedure the catalyst **192** (3.00 mg, 14.7 μmol , 5.00 mol-%), dichlorophthalazine **183a** (58.6 mg, 294 μmol , 1.00 equiv), diglyme (450 μl), enamine **203a** (80.8 mg, 589 μmol , 2.00 equiv) were stirred for 2.5 d at 40 °C. After workup, the residue was purified by chromatography over 15 g silica (cyclohexane) to yield white crystals (43.3 mg, 62%).

¹H-NMR: (400 MHz, CDCl_3) δ 8.29–8.20 (m, 2H; 5-H, 8-H), 7.63–7.56 (m, 2H; 6-H, 7-H), 3.27–3.18 (m, 4H; 1-H, 3-H), 2.26–2.16 (m, 2H; 2-H).

¹³C-NMR: (101 MHz, CDCl_3) δ 142.02, 131.51, 126.99, 125.91, 124.53, 34.05, 24.51.

MS: (70 eV) m/z (%): 236 (85) [M^+], 165 (100).

The compound has been prepared before.¹⁷

3-(8-Nitronaphthalen-2-yl)propan-1-ol (**217ba**), 3-(5-Nitronaphthalen-2-yl)propan-1-ol (**217bb**)

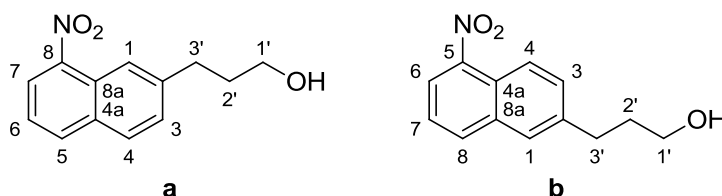

From 197b: According to the general procedure the phthalazine complex of catalyst **192** (7.3 mg, 21.8 μmol , 5.00 mol-%), 5-nitrophthalazine (**183b**) (76.3 mg, 0.437 mmol, 1.00 equiv), diglyme (450 μl), *N,N*-diisopropylethylamine (75 μl) and methyl dihydrofuran **197b** (74.0 mg, 0.880 mmol, 2.00 equiv) were stirred for 1 d at 100 °C, worked-up with TBME/hexane (1:1)

and distilled at 210 °C/0.4 mbar to obtain (44.3 mg, 44 %) of a mixture of regioisomers **217ba** and **217bb** in a 1.5:1 ratio.

From 197c: According to the general procedure the phthalazine complex of catalyst **192** (7.3 mg, 21.8 μmol, 5.00 mol-%), 5-nitrophthalazine (**183b**) (76.3 mg, 0.437 mmol, 1.00 equiv), diglyme (450 μl), *N,N*-diisopropylethylamine (75 μl) and methyl dihydrofuran **197c** (74.0 mg, 0.880 mmol, 2.00 equiv) were stirred for 2 d at 100 °C, worked-up with TBME/hexane (1:1) and distilled at 200 °C/0.5 mbar to obtain (34.0 mg, 41%) of a mixture of regioisomers **217ba** and **217bb** in a 1.5:1 ratio.

¹H-NMR: **a:** (400 MHz, CDCl₃) δ 8.36 (s, 1H; 1-H), 8.19 (dd, *J*=7.6, 1.0 Hz, 1H; 4-H), 8.06 (d, *J*=8.2 Hz, 1H; 5-H), 7.87 (d, *J*=8.4 Hz, 1H; 7-H), 7.51–7.44 (m, 2H, 3-H, 6-H), 3.77–3.67 (m, 2H; 1'-H), 2.99–2.85 (m, 2H; 3'-H), 2.05–1.93 (m, 2H; 2'-H).

¹H-NMR: **b:** (400 MHz, CDCl₃) δ 8.49 (d, *J*=8.9 Hz, 1H; 4-H), 8.16 (dd, *J*=7.7, 1.2 Hz, 1H; 1-H), 8.03 (d, *J*=8.4 Hz, 1H; 8-H), 7.74 (s, 1H; 6-H), 7.57 (dd, *J*=8.9, 1.7 Hz, 1H; 7-H), 7.51–7.44 (m, 1H; 3-H), 3.77–3.67 (m, *J*=6.4 Hz, 2H, 1'-H), 2.99–2.85 (m, 2H; 3'-H), 2.05–1.93 (m, 2H; 2'-H).

¹³C-NMR: (101 MHz, CDCl₃) δ 146.91, 146.62, 144.19, 141.63, 135.11, 134.81, 134.63, 133.47, 131.36, 129.22, 129.10, 127.52, 125.78, 124.64, 124.57, 124.12, 123.80, 123.76, 123.68, 122.07, 62.49, 62.38, 34.38, 34.13, 33.19, 32.27.

MS: (70 eV) *m/z* (%): 231 (9) [M⁺], 139 (100).

HRMS: (ESI): *m/z* calcd for [C₁₃H₁₄O₃N]⁺: [M+H]⁺ 232.0968; found: 232.0976.

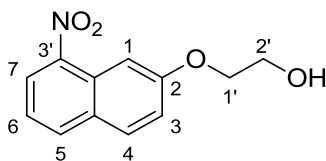
2-(8-Nitronaphthalen-2-yloxy)ethanol (**217c**)

The phthalazine complex of catalyst **192** (3.7 mg, 12 μmol , 5.0 mol-%), 5-nitrophthalazine (**183b**) (41.9 mg, 239 μmol , 1.00 equiv), diglyme (300 μl), *N,N*-diisopropylethylamine (100 μl) and dioxolane **197e** (41.2 mg, 479 μmol , 2.00 equiv) were stirred for 12 h at rt. After evaporation of the diglyme, the residue was purified by preparative TLC chromatography (silica; 2:3 hexane/EtOAc) to yield a solid (5.6 mg, 10%).

$^1\text{H-NMR}$: (400 MHz, CDCl_3) δ 8.35–8.29 (m, 1H), 8.11–8.02 (m, 2H), 7.92–7.83 (m, 1H), 7.46–7.39 (m, 1H), 7.36–7.30 (m, 1H), 4.33–4.22 (m, 2H; 1'-H), 4.13–4.02 (m, 2H; 2'-H).

$^{13}\text{C-NMR}$: (101 MHz, CDCl_3) δ 160.10, 135.15, 133.76, 130.86, 130.72, 127.27, 125.69, 122.35, 120.78, 102.92, 69.90, 61.69.

HRMS: (ESI) m/z calcd for $[\text{C}_{12}\text{H}_{12}\text{NO}_4]^+$: $[\text{M}+\text{H}]^+$ 234.0761; found: 234.0767.

5.6 One-pot synthesis of phthalazines and pyridazino-aromatics

General procedure: *n*-BuLi (4.00 ml, 6.40 mmol, 1.6 M in hexane, 1.07 equiv.) was added drop wise under nitrogen to a stirred solution of amine (Method A: **A1** = *N,N,N'*-trimethylethyldiamine, method B: **A2** = *bis*(2-methoxyethyl)amine; 6.60 mmol, 1.10 equiv.) in a mixture of dry hexane (10 ml) and THF (2.5 ml) at $-25\text{ }^{\circ}\text{C}$. After the addition the mixture was stirred at $-20\text{ }^{\circ}\text{C}$ for 30 min to form the lithium amide Li**A**. Aldehyde **238** (6.00 mmol, 1.00 equiv.) was added drop wise or portion wise at $-20\text{ }^{\circ}\text{C}$. The reaction mixture was stirred for 45 min and more *n*-BuLi (5.60 ml, 9.00 mmol, 1.6 M in hexane, 1.50 equiv.) was added at $-20\text{ }^{\circ}\text{C}$. The mixture was allowed to warm to $0\text{--}30\text{ }^{\circ}\text{C}$ for 10-20 min and stirred for 1.5-5 h. After cooling to $-78\text{ }^{\circ}\text{C}$, THF (5 ml) and DMF (1.40 ml, 18.0 mmol, 3.00 equiv.) were added and stirred for 10 min before the mixture was allowed to warm to $0\text{ }^{\circ}\text{C}$ and stirred for 1.5 h. The reaction was quenched after 1.5 h with a solution of NH_4Cl (0.96 g, 18.0 mmol, 3.00 equiv.) and $\text{N}_2\text{H}_4\cdot\text{H}_2\text{O}$ (0.70 ml, 11.5 mmol, 80% in H_2O , 1.90 equiv.) in H_2O (5 ml). The reaction was allowed to warm to rt and stirred for 14 h, diluted with ethyl acetate (15 ml) separated, extracted with ethyl acetate ($3 \times 20\text{ ml}$) dried over MgSO_4 and purified by column chromatography over SiO_2 (acetone/cyclohexane) to obtain the product.

Phthalazine (**244a**)

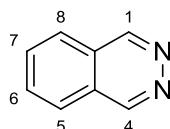

According to the general procedure (method A), lithium amide Li**A1** prepared from *N,N,N'*-trimethylethyldiamine **A1** (0.86 ml, 6.60 mmol, 1.10 equiv.) was reacted with benzaldehyde **238a** (0.61 ml, 6.00 mmol, 1.00 equiv.) for 45 min at $-20\text{ }^{\circ}\text{C}$ and more *n*-BuLi (5.60 ml, 9.00 mmol, 1.60 M in hexane, 1.50 equiv.) was added drop wise at $-20\text{ }^{\circ}\text{C}$. The mixture was allowed to warm to rt ($25\text{ }^{\circ}\text{C}$) for 20 min and stirred at rt for 2 h. After cooling to $-78\text{ }^{\circ}\text{C}$, THF (5 ml) and DMF (1.40 ml, 18.0 mmol, 3.00 equiv.) were added and stirred for 10 minutes before the mixture was allowed to warm to $0\text{ }^{\circ}\text{C}$ and stirred for 1.5 h. The reaction was quenched, stirred for 14 h, worked up and purified over SiO_2 (50g, acetone/cyclohexane 6:4) to obtain the crystalline product (579 mg, 74%).

According to the general procedure (method B), lithium amide Li**A2** prepared from *bis*(2-methoxyethyl)amine **A2** (0.98 ml, 6.60 mmol, 1.10 equiv.) was reacted with benzaldehyde

238a (0.61 ml, 6.00 mmol, 1.00 equiv.) for 45 min at $-20\text{ }^{\circ}\text{C}$ and more *n*-BuLi (5.60 ml, 9.00 mmol, 1.6 M in hexane, 1.50 equiv.) was added drop wise at $-20\text{ }^{\circ}\text{C}$. The mixture was allowed to warm to $0\text{ }^{\circ}\text{C}$ for 10 min and stirred for 5 h. After cooling to $-78\text{ }^{\circ}\text{C}$, THF (5 ml) and DMF (1.40 ml, 18.0 mmol, 3.00 equiv.) were added and stirred for 10 minutes before the mixture was allowed to warm to $0\text{ }^{\circ}\text{C}$. The reaction was quenched, stirred for 14 h, worked up and purified over SiO_2 (50g, acetone/cyclohexane 6:4) to obtain the crystalline product (563 mg, 72%).

$^1\text{H-NMR}$: (400 MHz, CDCl_3) δ 9.53 (s, 2H, 1-H, 4-H), 8.05 – 7.86 (m, 4H, 5-H, 6-H, 7-H, 8-H).

MS: (EI) *m/z* (%): 130 (M^+ , 100).

MP: $89.0 - 90.1\text{ }^{\circ}\text{C}$

The analytic data are in accordance with a commercial sample.

6-Methylphthalazine (**244b**)

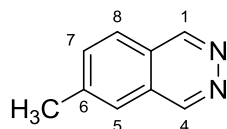

According to the general procedure (method A), lithium amide **LiA1** prepared from *N,N,N'*-trimethylethyldiamine **A1** (0.86 ml, 6.60 mmol, 1.10 equiv.) was reacted with *p*-tolualdehyde **238b** (721 mg, 6.00 mmol, 1.00 equiv.) for 45 min at $-20\text{ }^{\circ}\text{C}$ and more *n*-BuLi (5.60 ml, 9.00 mmol, 1.60 M in hexane, 1.50 equiv.) was added drop wise at $-20\text{ }^{\circ}\text{C}$. The mixture was allowed to warm to rt ($30\text{ }^{\circ}\text{C}$) for 20 min and stirred at rt for 1.5 h. After cooling to $-78\text{ }^{\circ}\text{C}$, THF (5 ml) and DMF (1.40 ml, 18.0 mmol, 3.00 equiv.) were added and stirred for 10 minutes before the mixture was allowed to warm to $0\text{ }^{\circ}\text{C}$. The reaction was quenched, stirred for 14 h, worked up and purified over SiO_2 (50g, acetone/cyclohexane 7:3) to obtain the crystalline product (730 mg, 84%).

¹H-NMR: (500 MHz, CDCl₃) δ 9.46 – 9.42 (m, 2H, 1-H, 4-H), 7.84 (d, *J* = 8.3 Hz, 1H, 8-H), 7.75 – 7.71 (m, 1H, 7-H), 7.71 – 7.69 (m, 1H, 5-H), 2.60 (s, 3H, CH₃).

¹³C-NMR: (126 MHz, CDCl₃) δ 150.89, 150.78, 143.55, 134.65, 126.78, 126.07, 125.22, 124.88, 22.25.

MS: (EI) *m/z* (%): 144 (M⁺, 100).

HRMS: (ESI) *m/z* calcd for [C₉H₉N₂]⁺: [M+H]⁺ 145.0760; found 145.0761.

MP: 71.8 – 73.3 °C.

6-Fluorophthalazine (244c)

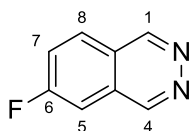

According to the general procedure (method A), lithium amide Li**A1** prepared from *N,N,N'*-trimethylethyldiamine **A1** (0.86 ml, 6.60 mmol, 1.10 equiv.) was reacted with 4-fluorobenzaldehyde **238c** (745 mg, 6.00 mmol, 1.00 equiv.) for 45 min at –20 °C and more *n*-BuLi (5.60 ml, 9.00 mmol, 1.60 M in hexane, 1.50 equiv.) was added drop wise at –20 °C. The mixture was allowed to warm to 0 °C for 10 min and stirred for 2 h. After cooling to –78 °C, THF (5 ml) and DMF (1.40 ml, 18.0 mmol, 3.00 equiv.) were added and stirred for 10 minutes before the mixture was allowed to warm to 0 °C and stirred for 1.5 h and stirred for 1.5 h. The reaction was quenched, stirred for 14 h, worked up and purified over SiO₂ (50g, acetone/cyclohexane 1:1) to obtain the crystalline product (468 mg, 53%).

According to the general procedure (method B), lithium amide Li**A2** prepared from *bis*(2-methoxyethyl)amine **A2** (0.98 ml, 6.60 mmol, 1.10 equiv.) was reacted with 4-fluorobenzaldehyde **238c** (745 mg, 6.00 mmol, 1.00 equiv.) for 45 min at –20 °C and more *n*-BuLi (5.60 ml, 9.00 mmol, 1.6 M in hexane, 1.50 equiv.) was added drop wise at –20 °C. The mixture was allowed to warm to 0 °C for 10 min and stirred for 2 h. After cooling to –78 °C, THF (5 ml) and DMF (1.40 ml, 18.0 mmol, 3.00 equiv.) were added and stirred for 10 minutes before the mixture was allowed to warm to 0 °C and stirred for 1.5 h. The reaction

was quenched, stirred for 14 h, worked up and purified over SiO₂ (50g, acetone/cyclohexane 1:1) to obtain the crystalline product (598 mg, 67%).

¹H-NMR: (400 MHz, CDCl₃) δ 9.52 (d, *J* = 9.2 Hz, 2H, 4-H, 1-H), 8.02 (dd, *J* = 8.9, 5.1 Hz, 1H, 8-H), 7.67 (td, *J* = 8.9, 2.5 Hz, 1H, 7-H), 7.62 – 7.53 (m, 1H, 5-H).

¹³C-NMR: (101 MHz, CDCl₃) δ 165.35, 162.80, 150.72, 150.67, 150.23, 129.70, 129.61, 128.05, 127.96, 123.63, 123.05, 122.80, 110.37, 110.15.

¹⁹F NMR: (376 MHz, CDCl₃) δ -101.59 (td, *J* = 8.3, 5.1 Hz).

¹⁹F NMR: (376 MHz, CDCl₃) δ -101.59.

MS: (ESI) *m/z*: 149 [M+H]⁺.

HRMS: (ESI) *m/z* calcd for [C₈H₆N₂F]⁺: [M+H]⁺ 149.0510; found 149.0508.

MP: 131.8 -136 °C.

5-Fluorophthalazine (244d)

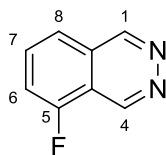

According to the general procedure (method B), lithium amide Li**A2** prepared from *bis*(2-methoxyethyl)amine **A2** (0.98 ml, 6.60 mmol, 1.10 equiv.) was reacted with 2-fluorobenzaldehyde **238d** (745 mg, 6.00 mmol, 1.00 equiv.) for 45 min at –20 °C and more *n*-BuLi (5.60 ml, 9.00 mmol, 1.6 M in hexane, 1.50 equiv.) was added drop wise at –20 °C. The mixture was allowed to warm to 0 °C for 10 min and stirred for 2 h. After cooling to –78 °C, THF (5 ml) and DMF (1.40 ml, 18.0 mmol, 3.00 equiv.) were added and stirred for 10 minutes before the mixture was allowed to warm to 0 °C and stirred for 1.5 h. The reaction was quenched, stirred for 14 h, worked up and purified over SiO₂ (50g, acetone/cyclohexane 1:1) to obtain the crystalline product (773 mg, 87%). Further purification by precipitation with cyclohexane from boiling acetone gave (662 mg, 75%).

¹H-NMR: (400 MHz, CDCl₃) δ 9.78 (dd, *J* = 1.6, 0.8 Hz, 1H, 4-H), 9.56 (t, *J* = 1.6 Hz, 1H, 1-H), 7.89 (td, *J* = 8.0, 5.1 Hz, 1H, 7-H), 7.77 (dt, *J* = 8.0, 0.8 Hz, 1H, 8-H), 7.57 (ddd, *J* = 9.3, 8.0, 0.8 Hz, 1H, 6-H).

¹³C-NMR: (101 MHz, CDCl₃) δ 158.77 (s), 156.20 (s), 150.19 (d, *J* = 2.8 Hz), 144.56 (d, *J* = 2.7 Hz), 133.39 (d, *J* = 7.9 Hz), 127.16 (d, *J* = 3.4 Hz), 122.13 (d, *J* = 4.7 Hz), 116.93 (dd, *J* = 17.7, 14.0 Hz).

¹⁹F NMR: (376 MHz, CDCl₃) δ -121.89 (ddd, *J* = 9.3, 5.1, 1.7 Hz).

¹⁹F NMR (376 MHz, CDCl₃) δ -121.89.

MS: (ESI) *m/z*: 149 [M+H]⁺

HRMS: (ESI) *m/z* calcd for [C₈H₆N₂F]⁺: [M+H]⁺ 149.0510; found 149.0513.

MP: 116.8 – 117.8 °C

6-Chlorophthalazine (244e)

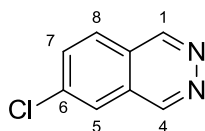

According to the general procedure (method A), lithium amide Li**A1** prepared from *N,N,N'*-trimethylethyldiamine **A1** (0.86 ml, 6.60 mmol, 1.10 equiv.) was reacted with 4-chlorobenzaldehyde **238e** (843 mg, 6.00 mmol, 1.00 equiv.) for 45 min at –20 °C and more *n*-BuLi (5.60 ml, 9.00 mmol, 1.60 M in hexane, 1.50 equiv.) was added drop wise at –25 °C. The mixture stirred for 3 h. After cooling to –78 °C, THF (5 ml) and DMF (1.40 ml, 18.0 mmol, 3.00 equiv.) were added and stirred for 10 minutes before the mixture was allowed to warm to 0 °C and stirred for 1.5 h. The reaction was quenched, stirred for 14 h, worked up and purified over SiO₂ (50g, acetone/cyclohexane 6:4) to obtain the crystalline product (784 mg, 79%).

According to the general procedure (method B), lithium amide Li**A2** prepared from *bis*(2-methoxyethyl)amine **A2** (0.98 ml, 6.60 mmol, 1.10 equiv.) was reacted with 4-chlorobenzaldehyde **238e** (843 mg, 6.00 mmol, 1.00 equiv.) for 45 min at –20 °C and more *n*-BuLi (5.60 ml, 9.00 mmol, 1.6 M in hexane, 1.50 equiv.) was added drop wise at –20 °C. The

mixture was allowed to warm to 0 °C for 10 min and stirred for 2 h. After cooling to –78 °C, THF (5 ml) and DMF (1.40 ml, 18.0 mmol, 3.00 equiv.) were added and stirred for 10 minutes before the mixture was allowed to warm to 0 °C and stirred for 1.5 h. The reaction was quenched, stirred for 14 h, worked up and purified over SiO₂ (50g, acetone/cyclohexane 6:4) to obtain the crystalline product (903 mg, 91%).

¹H-NMR: (500 MHz, CDCl₃) δ 9.52 (s, 1H, 1-H), 9.49 (s, 1H, 4-H), 8.01 – 7.95 (m, 1H, 5-H), 7.93 (dt, *J* = 8.6 Hz, 0.7 Hz, 1H, 8-H), 7.87 (dd, *J* = 8.6, 2.0 Hz, 1H, 7-H).

¹³C-NMR: (101 MHz, CDCl₃) 150.49, 150.07, 138.71, 133.74, 128.06, 127.18, 125.38, 124.70.

MS: (EI) *m/z* (%): 164 (M⁺, 100)

HRMS: (ESI) *m/z* calcd for [C₈H₆N₂Cl]⁺: [M+H]⁺ 165.0214; found 165.0216.

MP: 132.9 – 135.2 °C

5-Chlorophthalazine (**244f**)

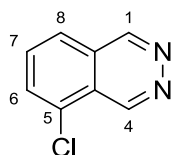

According to the general procedure (method A), lithium amide Li**A1** prepared from *N,N,N'*-trimethylethyldiamine **A1** (0.86 ml, 6.60 mmol, 1.10 equiv.) was reacted with 2-chlorobenzaldehyde **238f** (843 mg, 6.00 mmol, 1.00 equiv.) for 45 min at –20 °C and more *n*-BuLi (5.60 ml, 9.00 mmol, 1.60 M in hexane, 1.50 equiv.) was added drop wise at –20 °C. The mixture was allowed to warm to 0 °C for 10 min and stirred for 2 h. After cooling to –78 °C, THF (5 ml) and DMF (1.40 ml, 18.0 mmol, 3.00 equiv.) were added and stirred for 10 minutes before the mixture was allowed to warm to 0 °C and stirred for 1.5 h. The reaction was quenched, stirred for 14 h, worked up and purified over SiO₂ (50g, acetone/cyclohexane 6:4) to obtain the crystalline product (739 mg, 75%).

¹H-NMR: (500 MHz, CDCl₃) δ 9.88 (dd, *J* = 1.4, 0.9 Hz, 1H, 4-H), 9.53 (d, *J* = 1.4 Hz, 1H, 1-H), 7.93 (dd, *J* = 7.4, 1.3 Hz, 1H, 6-H), 7.91 – 7.87 (m, 1H, 8-H), 7.84 (dd, *J* = 8.1, 7.4 Hz, 1H, 7-H).

¹³C-NMR: (101 MHz, CDCl₃) δ 150.34, 147.52, 132.89, 132.72, 131.74, 127.60, 125.20, 124.18.

MS: (EI) *m/z* (%): 164 (M⁺, 100)

HRMS: (ESI) *m/z* calcd for [C₈H₆N₂Cl]⁺: [M+H]⁺ 165.0214; found 165.0216.

MP: 126.8 – 127.4 °C

6-(Trifluoromethyl)phthalazine (244g)

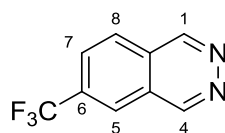

According to the general procedure (method A), lithium amide LiA1 prepared from *N,N,N'*-trimethylethyldiamine A1 (0.86 ml, 6.60 mmol, 1.10 equiv.) was reacted with 4-(trifluoromethyl)benzaldehyde (238g) (1.04 g, 6.00 mmol, 1.00 equiv.) for 45 min at –20 °C and more *n*-BuLi (5.60 ml, 9.00 mmol, 1.60 M in hexane, 1.50 equiv.) was added drop wise at –20 °C. The mixture was allowed to warm to 0 °C for 10 min and stirred for 2 h. After cooling to –78 °C, THF (5 ml) and DMF (1.40 ml, 18.0 mmol, 3.00 equiv.) were added and stirred for 10 minutes before the mixture was allowed to warm to 0 °C and stirred for 1.5 h. The reaction was quenched, stirred for 14 h, worked up and purified over SiO₂ (50g, acetone/cyclohexane 1:1) to obtain the crystalline product (1053 mg, 89%).

¹H-NMR: (400 MHz, CDCl₃) δ 9.66 (s, 2H, 1-H, 4-H), 8.30 (s, 1H, 5-H), 8.18 – 8.10 (m, 2H, 7-H, 8-H).

¹³C-NMR: (101 MHz, CDCl₃) δ 151.11 (s), 150.75 (s), 134.34 (d, *J* = 33.4 Hz), 128.60 (q, *J* = 3.0 Hz), 127.66 (s), 127.47 (s), 125.72 (s), 124.15 (q, *J* = 4.3 Hz), 123.06 (d, *J* = 273.0 Hz).

^{19}F NMR: (376 MHz, CDCl_3) δ -63.09.

MS: (ESI) m/z : 199 $[\text{M}+\text{H}]^+$

HRMS: (ESI) m/z calcd for $[\text{C}_9\text{H}_6\text{N}_2\text{F}_3]^+$: $[\text{M}+\text{H}]^+$ 199.0478; found 199.0477

MP: 132.3 – 135.2 °C

6-Phenylphthalazine (244h)

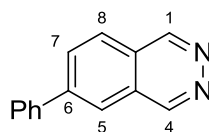

According to the general procedure (method A), lithium amide **LiA1** prepared from *N,N,N'*-trimethylethyldiamine **A1** (0.86 ml, 6.60 mmol, 1.10 equiv.) was reacted with 4-biphenylaldehyde **238h** (1.09 g, 6.00 mmol, 1.00 equiv.) for 45 min at -20 °C and more *n*-BuLi (5.60 ml, 9.00 mmol, 1.60 M in hexane, 1.50 equiv.) was added drop wise at -20 °C. The mixture was allowed to warm to rt (25 °C) for 20 min and stirred at rt for 2.5 h. After cooling to -78 °C, THF (5 ml) and DMF (1.40 ml, 18.0 mmol, 3.00 equiv.) were added and stirred for 10 minutes before the mixture was allowed to warm to 0 °C and stirred for 1.5 h. The reaction was quenched, stirred for 14 h, worked up and purified over SiO_2 (50g, acetone/cyclohexane 2:1) to obtain the crystalline product (989 mg, 80%).

^1H -NMR: (400 MHz, CDCl_3) δ 9.57 (dd, $J = 1.4, 0.8$ Hz, 1H, 4-H), 9.54 (dd, $J = 1.4, 0.8$ Hz, 1H, 1-H), 8.15 (dd, $J = 8.4, 1.7$ Hz, 1H, 7-H), 8.12 – 8.07 (m, 1H, 5-H), 8.02 (d, $J = 8.4$ Hz, 1H, 8-H), 7.76 – 7.65 (m, 2H, *o*-PhH), 7.57 – 7.49 (m, 2H, *m*-PhH), 7.49 – 7.39 (m, 1H, *p*-PhH).

^{13}C -NMR: (126 MHz, CDCl_3) δ 151.35, 150.84, 145.61, 139.17, 132.22, 129.29, 128.84, 127.60, 126.96, 126.83, 125.48, 123.84.

HRMS: (ESI) m/z calcd for $[\text{C}_{14}\text{H}_{11}\text{N}_2]^+$: $[\text{M}+\text{H}]^+$ 207.0917; found 207.0915.

MP: 140.7 – 141.6 °C

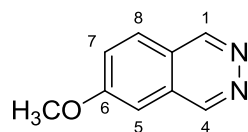
6-Methoxyphthalazine (244i)

According to the general procedure (method A), lithium amide LiA1 prepared from *N,N,N'*-trimethylethyldiamine A1 (0.86 ml, 6.60 mmol, 1.10 equiv.) was reacted with *p*-anisaldehyde 238i (817 mg, 6.00 mmol, 1.00 equiv.) for 45 min at $-20\text{ }^{\circ}\text{C}$ and more *n*-BuLi (5.60 ml, 9.00 mmol, 1.60 M in hexane, 1.50 equiv.) was added drop wise at $-20\text{ }^{\circ}\text{C}$. The mixture was allowed to warm to rt ($30\text{ }^{\circ}\text{C}$) for 20 min and stirred at rt for 1.5 h. After cooling to $-78\text{ }^{\circ}\text{C}$, THF (5 ml) and DMF (1.40 ml, 18.0 mmol, 3.00 equiv.) were added and stirred for 10 minutes before the mixture was allowed to warm to $0\text{ }^{\circ}\text{C}$ and stirred for 1.5 h. The reaction was quenched, stirred for 14 h, worked up and purified over SiO_2 (50g, acetone/cyclohexane 6:4) to obtain the crystalline product (781 mg, 81%).

$^1\text{H-NMR}$: (400 MHz, CDCl_3) δ 9.45 (dd, $J = 1.4, 0.8$ Hz, 1H, 4-H), 9.37 (dd, $J = 1.4, 0.8$ Hz, 1H, 1-H), 7.85 (d, $J = 8.9$ Hz, 1H, 8-H), 7.49 (dd, $J = 8.9, 2.4$ Hz, 1H, 7-H), 7.17 (d, $J = 2.4$ Hz, 1H, 5-H), 3.99 (s, 3H, OCH_3).

$^{13}\text{C-NMR}$: (101 MHz, CDCl_3) δ 162.46, 150.67, 150.10, 128.57, 128.10, 124.97, 122.08, 104.03, 55.86.

MS: (EI) m/z (%): 160 (M^+ , 100)

HRMS: (ESI) m/z calcd for $[\text{C}_9\text{H}_9\text{ON}_2]^+$: $[\text{M}+\text{H}]^+$ 161.0709; found 161.0711.

MP: $123.0 - 123.8\text{ }^{\circ}\text{C}$

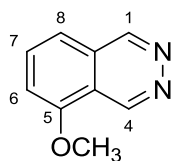
5-Methoxyphthalazine (244j)

According to the general procedure (method A), lithium amide Li**A1** prepared from *N,N,N'*-trimethylethyldiamine **A1** (0.86 ml, 6.60 mmol, 1.10 equiv.) was reacted with *m*-anisaldehyde **238j** (817 mg, 6.00 mmol, 1.00 equiv.) for 45 min at $-20\text{ }^{\circ}\text{C}$ and more *n*-BuLi (5.60 ml, 9.00 mmol, 1.60 M in hexane, 1.50 equiv.) was added drop wise at $-20\text{ }^{\circ}\text{C}$. The mixture was allowed to warm to rt ($30\text{ }^{\circ}\text{C}$) for 20 min and stirred at rt for 1.5 h. After cooling to $-78\text{ }^{\circ}\text{C}$, THF (5 ml) and DMF (1.40 ml, 18.0 mmol, 3.00 equiv.) were added and stirred for 10 minutes before the mixture was allowed to warm to $0\text{ }^{\circ}\text{C}$ and stirred for 1.5 h. The reaction was quenched, stirred for 14 h, worked up and purified over SiO₂ (50g, acetone/cyclohexane 6:4) to obtain the crystalline product (759 mg, 79%).

¹H-NMR: (500 MHz, CDCl₃) δ 9.83 (dd, $J = 1.5, 0.8$ Hz, 1H, 4-H), 9.47 (d, $J = 1.5$ Hz, 1H, 1-H), 7.81 (t, $J = 8.0$ Hz, 1H, 7-H), 7.48 (dt, $J = 8.0, 0.8$ Hz, 1H, 8-H), 7.21 (d, $J = 8.0$ Hz, 1H, 6-H), 4.06 (s, 3H, OCH₃).

¹³C-NMR: (126 MHz, CDCl₃) δ 155.13, 150.57, 146.18, 133.40, 127.27, 118.38, 117.57, 110.69, 55.94.

MS: (EI) m/z (%): 160 (M⁺, 100)

HRMS: (ESI) m/z calcd for [C₉H₉ON₂]⁺: [M+H]⁺ 161.0709; found 161.0716.

MP: 131.7 – 133.0 $^{\circ}\text{C}$

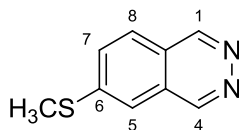
6-(Methylthio)phthalazine (**244k**)

According to the *general* procedure (method A), lithium amide Li**A1** prepared from *N,N,N'*-trimethylethyldiamine **A1** (0.86 ml, 6.60 mmol, 1.10 equiv.) was reacted with 4-(Methylthio)benzaldehyde (**238k**) (913 mg, 6.00 mmol, 1.00 equiv.) for 45 min at $-20\text{ }^{\circ}\text{C}$ and more *n*-BuLi (5.60 ml, 9.00 mmol, 1.60 M in hexane, 1.50 equiv.) was added drop wise at $-20\text{ }^{\circ}\text{C}$. The mixture was allowed to warm to rt ($30\text{ }^{\circ}\text{C}$) for 20 min and stirred at rt for 1.5 h. After cooling to $-78\text{ }^{\circ}\text{C}$, THF (5 ml) and DMF (1.40 ml, 18.0 mmol, 3.00 equiv.) were added and stirred for 10 minutes before the mixture was allowed to warm to $0\text{ }^{\circ}\text{C}$ and stirred for 1.5 h. The reaction was quenched, stirred for 14 h, worked up and purified over SiO_2 (50g, acetone/cyclohexane 6:4) to obtain the crystalline product (540 mg, 51%).

$^1\text{H-NMR}$: (500 MHz, CDCl_3) δ 9.44 (dd, $J = 1.5, 0.8$ Hz, 1H, 4-H), 9.42 (dd, $J = 1.5, 0.8$ Hz, 1H, 1-H), 7.83 – 7.79 (m, 1H, 8-H), 7.73 (dd, $J = 8.6, 1.9$ Hz, 1H, 7-H), 7.58 – 7.55 (m, 1H, 5-H), 2.64 (s, 3H, SCH_3).

$^{13}\text{C-NMR}$: (126 MHz, CDCl_3) δ 150.54, 150.13, 146.11, 131.20, 127.05, 126.10, 123.93, 119.21, 14.89.

MS: (EI) m/z (%): 176 (M^+ , 100)

HRMS: (ESI) m/z calcd for $[\text{C}_9\text{H}_9\text{N}_2\text{S}]^+$: $[\text{M}+\text{H}]^+$ 177.0481; found 177.0481.

MP: $87.5 - 88.6\text{ }^{\circ}\text{C}$

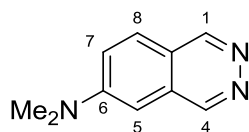
***N,N*-Dimethylphthalazin-6-amine (244l)**

According to the general procedure (method A), lithium amide LiA1 prepared from *N,N,N'*-trimethylethyldiamine A1 (0.86 ml, 6.60 mmol, 1.10 equiv.) was reacted with 4-(dimethylamino)benzaldehyde (238l) (895 mg, 6.00 mmol, 1.00 equiv.) for 45 min at $-20\text{ }^{\circ}\text{C}$ and more *n*-BuLi (5.60 ml, 9.00 mmol, 1.60 M in hexane, 1.50 equiv.) was added drop wise at $-20\text{ }^{\circ}\text{C}$. The mixture was allowed to warm to rt ($25\text{ }^{\circ}\text{C}$) for 20 min and stirred at rt for 2.5 h. After cooling to $-78\text{ }^{\circ}\text{C}$, THF (5 ml) and DMF (1.40 ml, 18.0 mmol, 3.00 equiv.) were added and stirred for 10 minutes before the mixture was allowed to warm to $0\text{ }^{\circ}\text{C}$ and stirred for 1.5 h. The reaction was quenched, stirred for 14 h, worked up and purified over SiO_2 (25g, acetone/cyclohexane 7:3) to obtain the crystalline product (640 mg, 62%).

$^1\text{H-NMR}$: (400 MHz, CDCl_3) δ 9.27 (s, 1H, 4-H), 9.16 (s, 1H, 1-H), 7.72 (d, $J = 9.0$ Hz, 1H, 8-H), 7.32 (ddd, $J = 9.0, 2.2, 1.3$ Hz, 1H, 7-H), 6.76 (s, 1H, 5-H), 3.12 (d, 6H, NMe_2).

$^{13}\text{C-NMR}$: (126 MHz, CDCl_3) δ 152.41, 150.57, 149.85, 128.82, 127.49, 119.97, 118.84, 102.40, 40.25.

HRMS: (ESI) m/z calcd for $[\text{C}_{10}\text{H}_{12}\text{N}_2]^+$: $[\text{M}+\text{H}]^+$ 174.1026; found 174.1024

MP: $127.2 - 127.8\text{ }^{\circ}\text{C}$

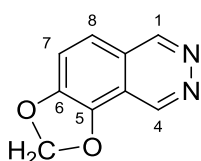
***[1,3]*Dioxolo[4,5-*f*]phthalazine (244m)**

According to the general procedure (method A), lithium amide LiA1 prepared from *N,N,N'*-trimethylethyldiamine A1 (0.86 ml, 6.60 mmol, 1.10 equiv.) was reacted with piperonal 238m

(901 mg, 6.00 mmol, 1.00 equiv.) for 45 min at $-20\text{ }^{\circ}\text{C}$ and more *n*-BuLi (5.60 ml, 9.00 mmol, 1.60 M in hexane, 1.50 equiv.) was added drop wise at $-20\text{ }^{\circ}\text{C}$. The mixture was allowed to warm to rt ($25\text{ }^{\circ}\text{C}$) for 20 min and stirred at rt for 2 h. After cooling to $-78\text{ }^{\circ}\text{C}$, THF (5 ml) and DMF (1.40 ml, 18.0 mmol, 3.00 equiv.) were added and stirred for 10 minutes before the mixture was allowed to warm to $0\text{ }^{\circ}\text{C}$ and stirred for 1.5 h. The reaction was quenched, stirred for 14 h, worked up and purified over SiO_2 (50g, acetone/cyclohexane 7:3) to obtain the crystalline product (684 mg, 66%).

$^1\text{H-NMR}$: (500 MHz, CDCl_3) δ 9.50 (dd, $J = 1.6, 0.8\text{ Hz}$, 1H, 1-H), 9.33 (d, $J = 1.6\text{ Hz}$, 1H, 4-H), 7.53 (dd, $J = 8.5, 0.8\text{ Hz}$, 1H, 8-H), 7.49 (d, $J = 8.5\text{ Hz}$, 1H, 7-H), 6.31 (s, 2H, CH_2).

$^{13}\text{C-NMR}$: (126 MHz, CDCl_3) δ 150.61, 149.56, 144.73, 141.05, 121.63, 121.34, 115.89, 112.11, 103.47.

MS: (EI) m/z (%): 174 (M^+ , 100)

HRMS: (ESI) m/z calcd for $[\text{C}_9\text{H}_7\text{O}_2\text{N}_2]^+$: $[\text{M}+\text{H}]^+$ 175.0502; 175.0504.

MP: $169.4 - 170.6\text{ }^{\circ}\text{C}$ (dec.)

5,6,7-Trimethoxyphthalazine (**244n**)

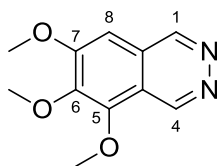

According to the general procedure (method A), lithium amide **LiA1** prepared from *N,N,N'*-trimethylethyldiamine **A1** (0.86 ml, 6.60 mmol, 1.10 equiv.) was reacted with 3,4,5-trimethoxybenzaldehyde **238n** (1.18 g, 6.00 mmol, 1.00 equiv.) for 45 min at $-20\text{ }^{\circ}\text{C}$ and more *n*-BuLi (5.60 ml, 9.00 mmol, 1.60 M in hexane, 1.50 equiv.) was added drop wise at $-20\text{ }^{\circ}\text{C}$. The mixture was allowed to warm to rt ($25\text{ }^{\circ}\text{C}$) for 20 min and stirred at rt for 2.5 h. After cooling to $-78\text{ }^{\circ}\text{C}$, THF (5 ml) and DMF (1.40 ml, 18.0 mmol, 3.00 equiv.) were added and stirred for 10 minutes before the mixture was allowed to warm to $0\text{ }^{\circ}\text{C}$ and stirred for 1.5 h.

The reaction was quenched, stirred for 14 h, worked up and purified over SiO₂ (50g, acetone/cyclohexane 7:3) to obtain the crystalline product (810 mg, 61%).

¹H-NMR: (500 MHz, CDCl₃) δ 9.61 (dd, *J* = 1.5, 0.7 Hz, 1H, 4-H), 9.35 (d, *J* = 1.5 Hz, 1H, 1-H), 6.99 (s, 1H, 8-H), 4.13 (s, 3H, OCH₃), 4.05 (s, 3H, OCH₃), 4.01 (s, 3H, OCH₃).

¹³C-NMR: (126 MHz, CDCl₃) δ 158.38, 149.45, 147.56, 145.38, 144.92, 124.19, 117.86, 100.37, 61.96, 61.39, 56.46.

MS: (EI) *m/z* (%): 220 (M⁺, 100)

HRMS: (ESI) *m/z* calcd for [C₁₁H₁₃O₃N₂]⁺: [M+H]⁺ 221.0921; found 221.0921.

MP: 115.8 -116.5 °C

5,6-Dimethoxyphthalazine (244o)

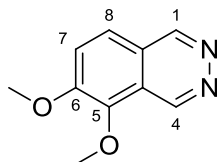

According to the general procedure (method A), lithium amide LiA1 prepared from *N,N,N'*-trimethylethyldiamine A1 (0.86 ml, 6.60 mmol, 1.10 equiv.) was reacted with veratraldehyde 238o (997 g, 6.00 mmol, 1.00 equiv.) for 45 min at -20 °C and more *n*-BuLi (5.60 ml, 9.00 mmol, 1.60 M in hexane, 1.50 equiv.) was added drop wise at -20 °C. The mixture was allowed to warm to rt (25 °C) for 20 min and stirred at rt for 2.5 h. After cooling to -78 °C, THF (5 ml) and DMF (1.40 ml, 18.0 mmol, 3.00 equiv.) were added and stirred for 10 minutes before the mixture was allowed to warm to 0 °C and stirred for 1.5 h. The reaction was quenched, stirred for 14 h, worked up and purified over SiO₂ (50g, acetone/cyclohexane 7:3) to obtain the crystalline product (499 mg, 44%).

$^1\text{H-NMR}$: (500 MHz, CDCl_3) δ 9.75 (dd, $J = 1.6, 0.8$ Hz, 1H, 1-H), 9.34 (d, $J = 1.6$ Hz, 1H, 4-H), 7.70 (dd, $J = 8.8, 0.8$ Hz, 1H, 8-H), 7.61 (d, $J = 8.8$ Hz, 1H, 7-H), 4.06 (s, 3H, OCH_3), 4.04 (s, 3H, OCH_3).

$^{13}\text{C-NMR}$: (126 MHz, CDCl_3) δ 153.24, 149.98, 146.22, 142.37, 122.91, 121.91, 121.60, 120.02, 61.86, 56.62.

MS: (EI) m/z (%): 190 (M^+ , 100)

HRMS: (ESI) m/z calcd for $[\text{C}_{10}\text{H}_{11}\text{O}_2\text{N}_2]^+$: $[\text{M}+\text{H}]^+$ 191.0815; found 191.0816.

MP: 103.1 – 103.8 °C

5,8-Dimethoxyphthalazine (**244p**)

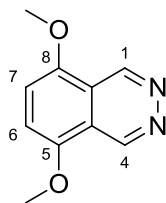

According to the general procedure (method A), lithium amide **LiA1** prepared from N,N,N' -trimethylethyldiamine **A1** (0.86 ml, 6.60 mmol, 1.10 equiv.) was reacted with 2,5-dimethoxybenzaldehyde **238p** (997 mg, 6.00 mmol, 1.00 equiv.) for 45 min at -20 °C and more $n\text{-BuLi}$ (5.60 ml, 9.00 mmol, 1.60 M in hexane, 1.50 equiv.) was added drop wise at -20 °C. The mixture was allowed to warm to rt (25 °C) for 20 min and stirred at rt for 2 h. After cooling to -78 °C, THF (5 ml) and DMF (1.40 ml, 18.0 mmol, 3.00 equiv.) were added and stirred for 10 minutes before the mixture was allowed to warm to 0 °C and stirred for 1.5 h. The reaction was quenched, stirred for 14 h, worked up and purified over SiO_2 (50g, acetone/cyclohexane 1:1) to obtain the crystalline product (409 mg, 36%).

$^1\text{H-NMR}$: (400 MHz, CDCl_3) δ 9.77 (s, 2H, 1-H, 4-H), 7.07 (s, 2H, 6-H, 7-H), 3.99 (s, 6 H).

$^{13}\text{C-NMR}$: (101 MHz, CDCl_3) δ 148.42, 145.73, 118.49, 110.68, 55.97.

MS: (EI) m/z (%): 190 (M^+ , 100)

HRMS: (ESI) m/z calcd for $[C_{10}H_{11}O_2N_2]^+$: $[M+H]^+$ 191.0820; 191.0822.

MP: 162.0 – 163.7 °C

Benzo[f]phthalazine (244q)

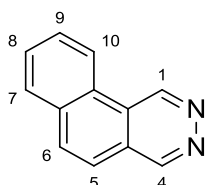

According to the general procedure (method A), lithium amide LiA1 prepared from *N,N,N'*-trimethylethyldiamine A1 (0.86 ml, 6.60 mmol, 1.10 equiv.) was reacted with 1-naphthaldehyde 238q (937 mg, 6.00 mmol, 1.00 equiv.) for 45 min at –20 °C and more *n*-BuLi (5.60 ml, 9.00 mmol, 1.60 M in hexane, 1.50 equiv.) was added drop wise at –20 °C. The mixture was allowed to warm to rt (30 °C) for 20 min and stirred at rt for 2 h. After cooling to –78 °C, THF (5 ml) and DMF (1.40 ml, 18.0 mmol, 3.00 equiv.) were added and stirred for 10 minutes before the mixture was allowed to warm to 0 °C and stirred for 1.5 h. The reaction was quenched, stirred for 14 h, worked up and purified over SiO₂ (50g, acetone/cyclohexane 6:4) to obtain the crystalline product (740 mg, 68%).

¹H NMR: (400 MHz, CDCl₃) δ 10.35 (d, J = 3.6 Hz, 1H), 9.63 (d, J = 3.1 Hz, 1H), 8.94 – 8.69 (m, 1H), 8.20 (dd, J = 8.7, 4.5 Hz, 1H), 8.05 (dd, J = 4.8, 2.5 Hz, 1H), 7.97 – 7.64 (m, 3H).

¹³C NMR: (101 MHz, CDCl₃) δ 150.79, 146.52, 134.33, 133.98, 129.60, 129.24, 128.70, 127.05, 125.86, 124.53, 122.64, 122.57.

MS: (ESI) m/z 181 $[M+H]^+$

HRMS: (ESI) m/z calcd for $[C_{12}H_9N_2]^+$: $[M+H]^+$ 181.0760; found 181.0759.

MP: 117.6 – 118.1 °C (dec.)

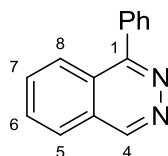
1-Phenylphthalazine (246)

According to the general procedure (method A), lithium amide LiA1 prepared from *N,N,N'*-trimethylethyldiamine A1 (0.86 ml, 6.60 mmol, 1.10 equiv.) was reacted with benzophenone 245 (1.09 g, 6.00 mmol, 1.00 equiv.) for 45 min at $-20\text{ }^{\circ}\text{C}$ and more *n*-BuLi (5.60 ml, 9.00 mmol, 1.60 M in hexane, 1.50 equiv.) was added drop wise at $-20\text{ }^{\circ}\text{C}$. The mixture was allowed to warm to rt ($25\text{ }^{\circ}\text{C}$) for 20 min and stirred at rt for 2 h. After cooling to $-78\text{ }^{\circ}\text{C}$, THF (5 ml) and DMF (1.40 ml, 18.0 mmol, 3.00 equiv.) were added and stirred for 10 minutes before the mixture was allowed to warm to $0\text{ }^{\circ}\text{C}$ and stirred for 1.5 h. The reaction was quenched, stirred for 14 h, worked up and purified over SiO_2 (50g, acetone/cyclohexane 4:6) to obtain the crystalline product (869 mg, 70%).

$^1\text{H-NMR}$: (400 MHz, CDCl_3) δ 9.54 (s, 1H, 4-H), 8.09 (d, $J = 8.3\text{ Hz}$, 1H, 8-H), 8.04 (d, $J = 7.5\text{ Hz}$, 1H, 5-H), 7.98 – 7.84 (m, 2H, 6-H, 7-H), 7.82 – 7.72 (m, 2H, *o*-HPh), 7.63 – 7.52 (m, 3H, Ph).

MS: (ESI) m/z 207 $[\text{M}+\text{H}]^+$

MP: 138.2 – 140.2 $^{\circ}\text{C}$

The analytic data are in accordance with the literature.¹⁸

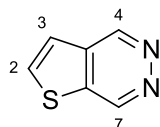
Thieno[2,3-d]pyridazino (248a)

According to the general procedure (method A), lithium amide LiA1 prepared from *N,N,N'*-trimethylethyldiamine A1 (0.86 ml, 6.60 mmol, 1.10 equiv.) was reacted with thiophene-2-carbaldehyde 247a (673 mg, 6.00 mmol, 1.00 equiv.) for 45 min at $-20\text{ }^{\circ}\text{C}$ and more *n*-BuLi

(5.60 ml, 9.00 mmol, 1.60 M in hexane, 1.50 equiv.) was added drop wise at $-20\text{ }^{\circ}\text{C}$. The mixture was allowed to warm to $0\text{ }^{\circ}\text{C}$ for 10 min and stirred for 2 h. Then THF (5 ml) and DMF (1.40 ml, 18.0 mmol, 3.00 equiv.) were added and stirred for 1.5 h. The reaction was quenched, stirred for 14 h, worked up and purified over SiO_2 (50g, acetone/cyclohexane 2:1) to obtain the crystalline product (395 mg, 48%).

According to the general procedure (method B), lithium amide LiA2 prepared from *bis*(2-methoxyethyl)amine **A2** (0.98 ml, 6.60 mmol, 1.10 equiv.) was reacted with thiophene-2-carbaldehyde **247a** (673 mg, 6.00 mmol, 1.00 equiv.) for 45 min at $-20\text{ }^{\circ}\text{C}$ and more *n*-BuLi (5.60 ml, 9.00 mmol, 1.6 M in hexane, 1.50 equiv.) was added drop wise at $-20\text{ }^{\circ}\text{C}$. The mixture was stirred for 2.5 h. Then, THF (5 ml) and DMF (1.40 ml, 18.0 mmol, 3.00 equiv.) were added and stirred for 10 minutes before the mixture was allowed to warm to $0\text{ }^{\circ}\text{C}$ and stirred for 1.5 h. The reaction was quenched, stirred for 14 h, worked up and purified over SiO_2 (50g, acetone/cyclohexane 2:1) to obtain the crystalline product (540 mg, 66%).

According to the general procedure (method B), lithium amide LiA2 prepared from *bis*(2-methoxyethyl)amine **A2** (0.98 ml, 6.60 mmol, 1.10 equiv.) was reacted with thiophene-3-carbaldehyde **247b** (673 mg, 6.00 mmol, 1.00 equiv.) for 45 min at $-20\text{ }^{\circ}\text{C}$ and more *n*-BuLi (5.60 ml, 9.00 mmol, 1.6 M in hexane, 1.50 equiv.) was added drop wise at $-20\text{ }^{\circ}\text{C}$. The mixture was stirred for 1 h. Then, THF (5 ml) and DMF (1.40 ml, 18.0 mmol, 3.00 equiv.) were added and stirred for 10 minutes before the mixture was allowed to warm to $0\text{ }^{\circ}\text{C}$ and stirred for 1.5 h. The reaction was quenched, stirred for 14 h, worked up and purified over SiO_2 (50g, acetone/cyclohexane 2:1) to obtain the crystalline product (661 mg, 81%).

$^1\text{H-NMR}$: (400 MHz, CDCl_3) δ 9.69 (s, 1H, 7-H), 9.58 (d, $J = 1.5\text{ Hz}$, 1H, 4-H), 7.88 (d, $J = 5.3\text{ Hz}$, 1H, 2-H), 7.54 (dd, $J = 5.3, 0.6\text{ Hz}$, 1H, 3-H).

MP: 165.2 – 166.9 $^{\circ}\text{C}$

The analytic data are in accordance with the literature.¹⁹

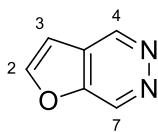
Furo[2,3-d]pyridazino (**248b**)

According to the general procedure (method A), lithium amide Li**A1** prepared from *N,N,N'*-trimethylethyldiamine **A1** (0.86 ml, 6.60 mmol, 1.10 equiv.) was reacted with furan-3-carbaldehyde **247c** (576 mg, 6.00 mmol, 1.00 equiv.) for 45 min at $-20\text{ }^{\circ}\text{C}$ and more *n*-BuLi (5.60 ml, 9.00 mmol, 1.60 M in hexane, 1.50 equiv.) was added drop wise at $-20\text{ }^{\circ}\text{C}$. The mixture was allowed to warm to $0\text{ }^{\circ}\text{C}$ for 10 min and stirred for 2 h. Then THF (5 ml) and DMF (1.40 ml, 18.0 mmol, 3.00 equiv.) were added and stirred for 1.5 h. The reaction was quenched, stirred for 14 h, worked up and purified over SiO_2 (50g, acetone/cyclohexane 6:4) to obtain the crystalline product (398 mg, 55%).

According to the general procedure (method B), lithium amide Li**A2** prepared from *bis*(2-methoxyethyl)amine **A2** (0.98 ml, 6.60 mmol, 1.10 equiv.) was reacted with furan-3-carbaldehyde **247c** (673 mg, 6.00 mmol, 1.00 equiv.) for 45 min at $-20\text{ }^{\circ}\text{C}$ and more *n*-BuLi (5.60 ml, 9.00 mmol, 1.6 M in hexane, 1.50 equiv.) was added drop wise at $-20\text{ }^{\circ}\text{C}$. The mixture was stirred for 2.5 h. Then, THF (5 ml) and DMF (1.40 ml, 18.0 mmol, 3.00 equiv.) were added and stirred for 10 minutes before the mixture was allowed to warm to $0\text{ }^{\circ}\text{C}$ and stirred for 1.5 h. The reaction was quenched, stirred for 14 h, worked up and purified over SiO_2 (50g, acetone/cyclohexane 6:4) to obtain the crystalline product (380 mg, 53%).

$^1\text{H-NMR}$: (400 MHz, CDCl_3) δ 9.57 (d, $J = 1.2\text{ Hz}$, 1H, 7-H), 9.53 (s, 1H, 4-H), 7.87 (d, $J = 2.1\text{ Hz}$, 1H, 2-H), 6.94 (d, $J = 1.9\text{ Hz}$, 1H, 3-H).

MS: (EI) m/z (%): 120 (M^+ , 100)

MP: 108.0 – 108.7 $^{\circ}\text{C}$

The analytic data are in accordance with the literature.^{20,21}

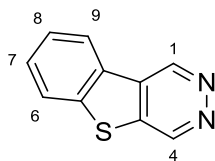
Benzo[4,5]thieno[2,3-d]pyridazine (248c)

According to the general procedure (method A), lithium amide Li**A1** prepared from *N,N,N'*-trimethylethyldiamine **A1** (0.86 ml, 6.60 mmol, 1.10 equiv.) was reacted with benzo[*b*]thiophene-3-carbaldehyde **247d** (973 mg, 6.00 mmol, 1.00 equiv.) for 45 min at -20 °C and more *n*-BuLi (5.60 ml, 9.00 mmol, 1.60 M in hexane, 1.50 equiv.) was added drop wise at -20 °C. The mixture was stirred for 2 h. Then THF (5 ml) and DMF (1.40 ml, 18.0 mmol, 3.00 equiv.) were added and stirred for 1.5 h. The reaction was quenched, stirred for 14 h, worked up and purified over SiO₂ (50g, acetone/cyclohexane 1:1) to obtain the crystalline product (703 mg, 63%).

According to the general procedure (method B), lithium amide Li**A2** prepared from *bis*(2-methoxyethyl)amine **A2** (0.98 ml, 6.60 mmol, 1.10 equiv.) was reacted with benzo[*b*]thiophene-3-carbaldehyde **247d** (973 mg, 6.00 mmol, 1.00 equiv.) for 45 min at -20 °C and more *n*-BuLi (5.60 ml, 9.00 mmol, 1.6 M in hexane, 1.50 equiv.) was added drop wise at -20 °C. The mixture was stirred for 2.5 h. Then, THF (5 ml) and DMF (1.40 ml, 18.0 mmol, 3.00 equiv.) were added and stirred for 10 minutes before the mixture was allowed to warm to 0 °C and stirred for 1.5 h. The reaction was quenched, stirred for 14 h, worked up and purified over SiO₂ (50g, acetone/cyclohexane 1:1) to obtain the crystalline product (556 mg, 50%).

¹H-NMR: (400 MHz, CDCl₃) δ 10.15 (s, 1H, 1-H), 8.68 (d, $J = 7.9$ Hz, 1H, 4-H), 8.32 (s, 1H, 9-H), 7.89 (d, $J = 7.9$ Hz, 1H, 6-H), 7.58 – 7.42 (m, 2H, 7-H, 8-H).

MS: (EI) m/z (%): 186 (M⁺, 100)

MP: 128.0 – 129.0 °C

The analytic data are in accordance with the literature.²²

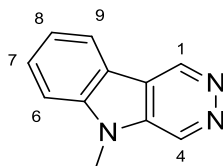
5-Methyl-5H-pyridazino[4,5-b]indole (248d)

According to the general procedure (method A), lithium amide LiA1 prepared from *N,N,N'*-trimethylethyldiamine A1 (0.86 ml, 6.60 mmol, 1.10 equiv.) was reacted with 1-methylindole-3-carboxaldehyde 247e (955 mg, 6.00 mmol, 1.00 equiv.) for 45 min at $-20\text{ }^{\circ}\text{C}$ and more *n*-BuLi (5.60 ml, 9.00 mmol, 1.60 M in hexane, 1.50 equiv.) was added drop wise at $-20\text{ }^{\circ}\text{C}$. The mixture was allowed to warm to $0\text{ }^{\circ}\text{C}$ for 10 min and stirred for 2 h. Then THF (5 ml) and DMF (1.40 ml, 18.0 mmol, 3.00 equiv.) were added and stirred for 1.5 h. The reaction was quenched, stirred for 14 h, worked up and purified over SiO₂ (50g, acetone/cyclohexane 8:2) to obtain the crystalline product (566 mg, 52%).

According to the general procedure (method B), lithium amide LiA2 prepared from *bis*(2-methoxyethyl)amine A2 (0.98 ml, 6.60 mmol, 1.10 equiv.) was reacted with 1-methylindole-3-carboxaldehyde 247e (955 mg, 6.00 mmol, 1.00 equiv.) for 45 min at $-20\text{ }^{\circ}\text{C}$ and more *n*-BuLi (5.60 ml, 9.00 mmol, 1.6 M in hexane, 1.50 equiv.) was added drop wise at $-20\text{ }^{\circ}\text{C}$. The mixture was stirred for 2.5 h. Then, THF (5 ml) and DMF (1.40 ml, 18.0 mmol, 3.00 equiv.) were added and stirred for 10 minutes before the mixture was allowed to warm to $0\text{ }^{\circ}\text{C}$ and stirred for 1.5 h. The reaction was quenched, stirred for 14 h, worked up and purified over SiO₂ (50g, acetone/cyclohexane 8:2) to obtain the crystalline product (580 mg, 53%).

¹H-NMR: (400 MHz, CDCl₃) δ 9.81 (d, $J = 1.3$ Hz, 1H, 1-H), 9.52 (d, $J = 1.3$ Hz, 1H, 4-H), 8.24 (d, $J = 7.9$ Hz, 1H, 9-H), 7.77 – 7.67 (m, 1H, 6-H), 7.60 (d, $J = 8.3$ Hz, 1H, 7-H), 7.47 (t, $J = 7.5$ Hz, 1H, 8-H), 4.03 (s, 3H, CH₃).

MS: (ESI) m/z : 184 [M+H]⁺

MP: 152.4 – 154.8 $^{\circ}\text{C}$

The analytic data are in accordance with the literature.²³

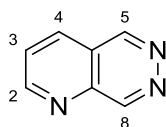
Pyrido[2,3-d]pyridazine (248e)

According to the general procedure (method B), lithium amide Li**A2** prepared from *bis*(2-methoxyethyl)amine **A2** (0.98 ml, 6.60 mmol, 1.10 equiv.) was reacted with picolinaldehyde **247f** (643mg, 6.00 mmol, 1.00 equiv.) for 45 min at $-20\text{ }^{\circ}\text{C}$ and more *n*-BuLi (5.60 ml, 9.00 mmol, 1.6 M in hexane, 1.50 equiv.) was added drop wise at $-20\text{ }^{\circ}\text{C}$. The mixture was stirred for 1.3 h. Then, THF (5 ml) and DMF (1.40 ml, 18.0 mmol, 3.00 equiv.) were added and stirred for 10 minutes before the mixture was allowed to warm to $0\text{ }^{\circ}\text{C}$. The reaction was quenched, stirred for 14 h, worked up and purified over SiO_2 (50g, acetone/cyclohexane 1:3 – 1:2) to obtain the crystalline product (770 mg, 69%). Further purification by precipitation with cyclohexane from boiling acetone gave (465 mg, 59%).

$^1\text{H-NMR}$: (400 MHz, CDCl_3) δ 9.82 (s, 1H, 8-H), 9.60 (d, $J = 1.3\text{ Hz}$, 1H, 5-H), 9.29 (dd, $J = 4.3, 1.6\text{ Hz}$, 1H, 4-H), 8.32 (dd, $J = 8.2, 0.6\text{ Hz}$, 1H, 2-H), 7.85 (dd, $J = 8.2, 4.3\text{ Hz}$, 1H, 3-H).

MS: (ESI) m/z : 132 $[\text{M}+\text{H}]^+$

MP: 151.2 – 152.9 $^{\circ}\text{C}$

The analytic data are in accordance with the literature.²⁴

5.7 Two step synthesis of substituted naphthalenes

5.7.1 Two-step (\pm) Naproxen synthesis

Ethyl 2-methyl-4-oxobutanoate (249a)

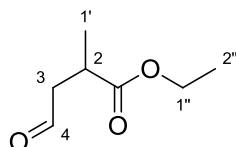

O₃ was bubbled through a stirred solution of olefin **251** (21.1 mmol, 3 g) in DCM (75 ml) at -78 °C until a blue color persisted. The solution was purged until it became colorless, and PPh₃ (25.3 mmol, 6.64 g) was added. The reaction was allowed to warm to room temperature and stirred for 18 h, concentrated to 30 ml and diluted with pentane. The suspension was filtered, the filtrate concentrated and bulb-to-bulb distillation afford a colorless liquid (2593 mg, 85.3%).

¹H-NMR: (500 MHz, CDCl₃) δ 9.80 – 9.69 (m, 1H, 4-H), 4.20 – 4.06 (m, 2H, 1''-H), 3.02 – 2.81 (m, 2H, 3-H), 2.58 – 2.46 (m, 1H, 2-H), 1.35 – 1.08 (m, 6H, 1'-H, 2''-H).

MS: (EI) m/z : 144 (M⁺, 0.02).

The analytic data are in accordance with the literature.²⁵

2-(6-Methoxynaphthalen-2-yl)propanoic acid (250a)

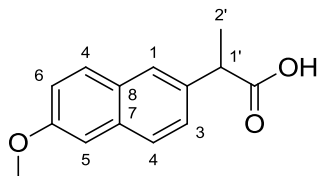

To a suspension of 6-methoxyphthalazine **244i** (47.1 mg, 294 μ mol, 1.00 equiv) in THF (0.5 ml) was added catalyst **192** (3.00 mg, 14.7 μ mol, 0.05 equiv) stirred for 5 min. Aldehyde **249a** (106 mg, 736 μ mol, 2.50 equiv) and pyrrolidine (25.1 mg, 353 μ mol, 1.20 equiv) was added and the reaction was stirred for 16h at 60 °C. Then H₂O (0.7 ml) and NaOH (141mg,

3.53 mmol, 12 equiv) were added stirred for 24h at 65 °C, acidified with 3M aq. HCl (1.5 ml), extracted with DCM (3 × 1.5 ml), dried over Na₂SO₄ and purified over SiO₂ (15g, ethylacetate/cyclohexane 1:1) to obtain the crystalline product (35.8 mg, 53%).

¹H-NMR: (500 MHz, CDCl₃) δ 11.30 (s, 1H), 7.80 – 7.65 (m, 3H), 7.44 (dd, *J* = 8.5, 1.7 Hz, 1H), 7.16 (dd, *J* = 8.9, 2.5 Hz, 1H), 7.13 (d, *J* = 2.1 Hz, 1H), 3.93 (s, 4H), 3.89 (q, *J* = 7.1 Hz, 1H), 1.61 (d, *J* = 7.2 Hz, 4H).

MS: (EI) *m/z*: 230 (M⁺, 58).

MP: 148.7 - 149.9 °C

The analytic data are in accordance with the literature.²⁶

5.7.2 Two step synthesis of silylnaphthalenes

(5,8-Difluoronaphthalene-2,3-diyl)bis(trimethylsilane) (**253a**)

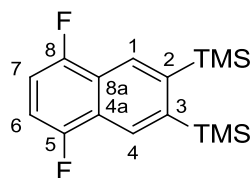

To a suspension of 5,8-difluoronaphthalazine **244s** (65.2 mg, 392 μmol, 1.00 equiv) in diglyme (0.5 ml) was added catalyst **192** (4.00 mg, 19.6 μmol, 0.05 equiv) stirred for 5 min. Bis(trimethylsilyl)acetylene **252** (100 mg, 589 μmol, 1.50 equiv) was added and the reaction was stirred for 7 d at 160 °C. The reaction mixture was evaporated and purified over SiO₂ (10 g, cyclohexane) to obtain the product as a white solid (61.2 mg, 51%).

¹H-NMR: (400 MHz, CDCl₃) δ 8.42 – 8.36 (m, 2H, 1-H, 4-H), 7.09 – 7.00 (m, 2H, 6-H, 7-H), 0.48 (s, 18H, TMS).

¹³C-NMR: (101 MHz, CDCl₃) δ 152.61 (dd, *J* = 250.3, 5.4 Hz), 142.45, 125.49, 121.09 (dd, *J* = 12.7, 10.0 Hz), 107.32 (dd, *J* = 18.2, 13.3 Hz), 0.00 (9 C).

¹⁹F-NMR: (376 MHz, CDCl₃) δ -129.01.

MS: (EI) m/z (%): 308 (M^+ , 32) 277 (100).

(5,8-Dichloronaphthalene-2,3-diyl)bis(trimethylsilane) (**253b**)

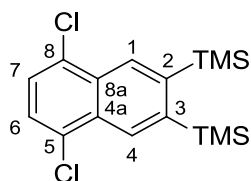

To a suspension of 5,8-dichlorophthalazine **244r** (58.6 mg, 294 μmol , 1.00 equiv) in diglyme (0.5 ml) was added catalyst **192** (1.50 mg, 7.36 μmol , 0.025 equiv) stirred for 5 min. Bis(trimethylsilyl)acetylene **252** (75.2 mg, 441 μmol , 1.50 equiv) was added and the reaction was stirred for 10 d at 150 °C. The reaction mixture was evaporated and purified over SiO_2 (10 g, cyclohexane) to obtain the product as a white solid (49.9 mg, 50%).

$^1\text{H-NMR}$: (400 MHz, CDCl_3) δ 8.71 – 8.42 (m, 2H, 1-H, 4-H), 7.47 (s, 2H, 6-H, 7-H), 0.49 (s, 18H, TMS).

$^{13}\text{C-NMR}$: (101 MHz, CDCl_3) δ 143.29, 130.05, 129.07, 128.38, 124.50, 0.00.

MS: (EI) m/z (%): 340 (M^+ , 34) 309 (100).

5.8 Domino IEDDA/cyclopropanation reaction

Furans **257a**, **257b** were purchased from Aldrich and **257c**²⁷, **257d**²⁸, **257e**²⁹ have been prepared in one step by standard literature procedures. Phthalazine **244a** was purchased from Aldrich and **244c**, **244e**, **244f**, **244g**, **244h**, **244i**, **244j**, **244k**, **244l** have been prepared according to above procedure and have additionally been purified via sublimation. Catalytic IEDDA/cyclopropanation reactions have been carried out under nitrogen atmosphere with degassed furans **257a** – **257e**. The solvent diglyme was used as purchased from Aldrich.

5.8.1 Phthalazine Synthesis

5,8-Dichlorophthalazine (**244r**)

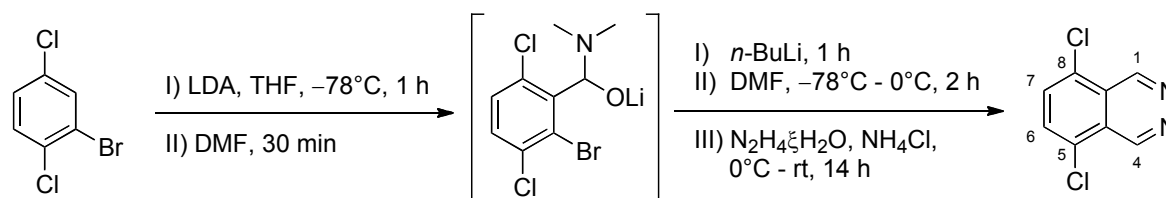

LDA (3.15 ml, 6.30 mmol, 2 M in THF/heptanes/ethylbenzene, 1.05 equiv) was added drop-wise to bromodichlorobenzene **271r** (1.36 g, 6.00 mmol, 1.00 equiv) in THF (10 ml) within 10 min maintaining the temperature below -65 °C. After stirring for 2 h at -78 °C, DMF (0.51 ml, 6.60 mmol, 1.10 equiv) was added. The mixture was stirred at -78 °C for 1 h and then *n*-BuLi (7.50 ml, 12.0 mmol, 1.60 M in hexane, 2.00 equiv) was added drop-wise at -78 °C. After 1 h, DMF (1.62 ml, 21.0 mmol, 3.50 equiv) was added, the mixture was stirred at -78 °C for 15 min and then allowed to warm during 20 min to 0 °C. After 2 h the reaction was quenched with a solution of NH_4Cl (0.96 g, 18.0 mmol, 3.00 equiv) and $\text{N}_2\text{H}_4\cdot\text{H}_2\text{O}$ (1.82 ml, 30.0 mmol, 80% in H_2O , 5.00 equiv) in H_2O (5 ml). The reaction mixture was allowed to warm to rt, stirred for 14 h, extracted with DCM (3×25 ml) dried over Na_2SO_4 and purified over SiO_2 (50 g, acetone/cyclohexane 1:1) to obtain the crystalline product (651 mg, 55%).

¹H NMR: (400 MHz, CDCl_3) δ 9.90 (s, 2H, 1-H, 4-H), 7.87 (s, 2H, 6-H, 7-H).

¹³C NMR: (101 MHz, CDCl_3) δ 147.0, 132.7, 130.5, 125.1.

HRMS: (ESI) *m/z* calcd for $[\text{C}_8\text{H}_5\text{N}_2\text{Cl}_2]^+$: $[\text{M}+\text{H}]^+$ 198.9824; found 198.9823.

MS: (EI) *m/z* (%): 198 (M^+ , 100).

MP: 215.2 – 216.2 °C.

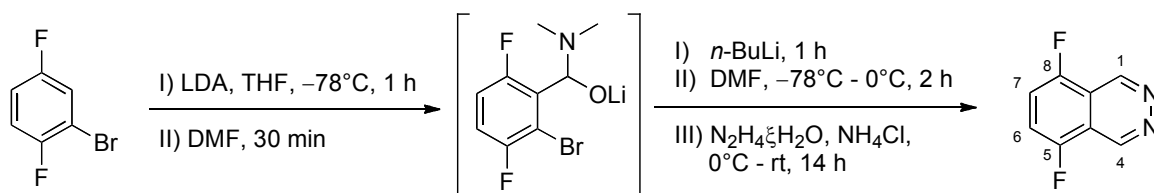
5,8-Difluorophthalazine (**244s**)

LDA (3.15 ml, 6.30 mmol, 2 M in THF/heptanes/ethylbenzene, 1.05 equiv) was added drop-wise to bromodifluorobenzene **271s** (1.16 g, 6.00 mmol, 1.00 equiv) in THF (10 ml) within 10 min maintaining the temperature below $-65\text{ }^{\circ}\text{C}$. After stirring for 1 h at $-78\text{ }^{\circ}\text{C}$, DMF (0.51 ml, 6.60 mmol, 1.10 equiv) was added. The mixture was stirred at $-78\text{ }^{\circ}\text{C}$ for 30 min and then *n*-BuLi (4.30 ml, 6.90 mmol, 1.60 M in hexane, 1.15 equiv) was added drop-wise at $-78\text{ }^{\circ}\text{C}$. After 1 h, DMF (0.70 ml, 9.00 mmol, 1.50 equiv) was added, the mixture was stirred at $-78\text{ }^{\circ}\text{C}$ for 20 min and then allowed to warm to $0\text{ }^{\circ}\text{C}$. After 1.5 h the reaction was quenched with a solution of NH_4Cl (0.96 g, 18.0 mmol, 3.00 equiv) and $\text{N}_2\text{H}_4\cdot\text{H}_2\text{O}$ (1.82 ml, 30.0 mmol, 80% in H_2O , 5.00 equiv) in H_2O (5 ml). The reaction mixture was allowed to warm to rt, stirred for 14 h, extracted with DCM ($3 \times 25\text{ ml}$) dried over Na_2SO_4 and purified over SiO_2 (50 g, acetone/cyclohexane 1:1) to obtain the crystalline product (702 mg, 70%).

$^1\text{H-NMR}$: (400 MHz, CDCl_3) δ 9.77 (s, 2H, 1-H, 4-H), 7.54 (t, $J = 6.2\text{ Hz}$, 2H, 6-H, 7-H).

$^{13}\text{C-NMR}$: (101 MHz, CDCl_3) δ 153.4 (dd, $J = 257.5, 6.2\text{ Hz}$), 144.0 (t, $J = 2.1\text{ Hz}$), 117.3 (dd, $J = 17.7, 12.0\text{ Hz}$), 116.7 (dd, $J = 13.7, 9.1\text{ Hz}$).

$^{19}\text{F-NMR}$: (376 MHz, CDCl_3) δ -126.5 (t, $J = 6.2\text{ Hz}$).

EA: (%) for $\text{C}_8\text{H}_4\text{F}_2\text{N}_2$: calcd C, 57.84; H, 2.43; N, 16.86; found C, 58.03; H, 2.67; N, 16.88.

MS: (EI) m/z (%): 166 (M^+ , 100).

MP: 172.9 – 173.4 $^{\circ}\text{C}$.

5.8.2 Scope of dienophiles

General procedure: Catalyst **192** (2 - 5 mol %) and phthalazine **244a** (1.00 equiv) in diglyme (0.5 - 1.5 ml) were thoroughly stirred for 1 min. Furan **257** (1.25 - 1.75 equiv) was added, the reaction mixture was stirred at the given temp. for the given time, evaporated and purified by column chromatography over SiO₂ (15 g, ethylacetate/cyclohexane) to obtain the product.

1a,7b-Dihydro-1H-cyclopropa[a]naphthalene-1-carboxylic acid (258a)

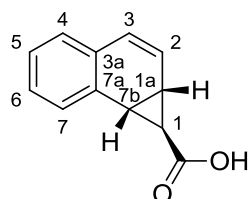

According to the general procedure catalyst **192** (2.9 mg, 14.2 μmol, 3.00 mol %), phthalazine (**244a**) (61.7 mg, 474 μmol, 1.00 equiv) and silyloxyfuran **275a** (94.5 mg, 593 μmol, 1.25 equiv) in diglyme (0.50 ml) were stirred for 3.5 d at 125 °C. The reaction mixture was evaporated and purified over SiO₂ (8:2 cyclohexane/ethylacetate + 1% AcOH) to yield 77.8 mg of crystalline product (88 %).

¹H-NMR: (400 MHz, CDCl₃) δ 11.27 (brs, 1H, OH), 7.51 – 7.39 (m, 1H, 4-H), 7.32 – 7.21 (m, 2H, 5-H, 6-H), 7.21 – 7.11 (m, 1H, 7-H), 6.44 (d, *J* = 9.6 Hz, 1H, 3-H), 6.32 (dd, *J* = 9.6, 5.1 Hz, 1H, 2-H), 3.18 (dd, *J* = 8.4, 4.0 Hz, 1H, 7b-H), 2.74 (ddd, *J* = 8.5, 4.8, 3.9 Hz, 1H, 1a-H), 0.87 (t, *J* = 3.9 Hz, 1H, 1-H).

¹³C-NMR: (400 MHz, CDCl₃) δ 182.7, 132.7, 131.1, 129.2, 128.5, 128.2, 127.5, 126.7, 126.0, 31.9, 29.0, 23.2.

MS: (EI) *m/z* (%): 186 (M⁺, 32), 141 (100).

The analytic data are in accordance with the literature.³⁰

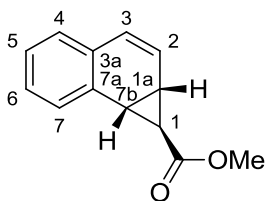
Methyl-1a,7b-dihydro-1H-cyclopropa[a]naphthalene-1-carboxylate (258b)

According to the general procedure catalyst **192** (4.6 mg, 22.6 μmol , 5.00 mol %), phthalazine (**244a**) (58.7 mg, 451 μmol , 1.00 equiv) and silyloxyfuran **257b** (66.4 mg, 677 μmol , 1.5 equiv) in diglyme (0.50 ml) were stirred for 4 d at 140 $^{\circ}\text{C}$. The reaction mixture was evaporated and purified over SiO_2 (19:1 cyclohexane/ethylacetate) to yield 72.2 mg of liquid product (80 %).

$^1\text{H-NMR}$: (400 MHz, CDCl_3) δ 7.36 – 7.29 (m, 1H, 4-H), 7.19 – 7.09 (m, 2H, 5-H, 6-H), 7.08 – 7.01 (m, 1H, 7-H), 6.32 (d, $J = 9.6$ Hz, 1H, 3-H), 6.21 (dd, $J = 9.6, 5.1$ Hz, 1H, 2-H), 3.65 (s, 3H, CO_2CH_3), 3.00 (dd, $J = 8.4, 4.0$ Hz, 1H, 7b-H), 2.59 – 2.52 (m, 1H, 1a-H), 0.78 (t, $J = 3.9$ Hz, 1H, 1-H).

$^{13}\text{C-NMR}$: (400 MHz, CDCl_3) δ 176.0, 132.6, 130.8, 128.8, 128.0, 127.7, 126.9, 126.0, 125.9, 52.2, 30.6, 27.7, 22.7.

MS: (EI) m/z (%): 200 (M^+ , 36), 141 (100).

The analytic data are in accordance with the literature.³¹

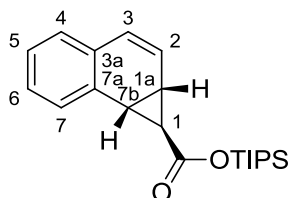
Triisopropylsilyl-1a,7b-Dihydro-1H-cyclopropa[a]naphthalene-1-carboxylate (258c)

According to the general procedure catalyst **192** (1.5 mg, 7.4 μmol , 2.50 mol %), phthalazine (**244a**) (38.3 mg, 294 μmol , 1.00 equiv) and silyloxyfuran **257c** (88.4 mg, 368 μmol , 1.25 equiv) in diglyme (0.50 ml) were stirred for 2.5 d at 155 $^{\circ}\text{C}$. The reaction mixture was

evaporated and purified over SiO₂ (49:1 cyclohexane/ethylacetate) to yield 100 mg of liquid product (99 %).

¹H-NMR: (500 MHz, CDCl₃) δ 7.43 – 7.38 (m, 1H, 7-H), 7.27 – 7.19 (m, 2H, 5-H, 6-H), 7.17 – 7.12 (m, 1H, 4-H), 6.41 (d, *J* = 9.6 Hz, 1H, 3-H), 6.32 (dd, *J* = 9.6, 5.0 Hz, 1H, 2-H), 3.07 (dd, *J* = 8.4, 4.0 Hz, 1H, 7b-H), 2.65 (ddd, *J* = 8.5, 5.0, 3.6 Hz, 1H, 1a-H), 1.32 (hept, *J* = 14.5, 7.4 Hz, 3H, SiCH₃), 1.10 (d, *J* = 7.4 Hz, 18H, CH₃), 0.87 (t, *J* = 3.8 Hz, 1H, 1-H).

¹³C-NMR: (126 MHz, CDCl₃) δ 175.4, 132.7, 130.7, 128.7, 127.9, 127.7, 126.8, 126.1, 125.9, 31.0, 27.9, 24.1, 17.8 (6 C), 12.0 (3 C).

EA: (%) for C₂₁H₃₀O₂Si: calcd C, 73.63; H, 8.83; found C, 73.13; H, 8.69.

MS: (EI) *m/z* (%): 342 (M⁺, 6), 299 (75), 141 (100).

1-Methyl-1a,7b-dihydro-1H-cyclopropa[a]naphthalene-1-carboxylic acid (258d)

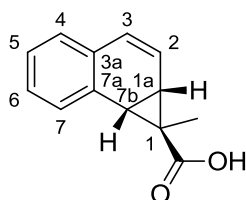

According to the general procedure catalyst **192** (2.9 mg, 14.2 μmol, 3.00 mol %), phthalazine (**244a**) (61.7 mg, 474 μmol, 1.00 equiv) and silyloxyfuran **257d** (101 mg, 593 μmol, 1.25 equiv) in diglyme (0.50 ml) were stirred for 1.5 d at 115 °C. The reaction mixture was evaporated and purified over SiO₂ (8:2 cyclohexane/ethylacetate + 1% AcOH) to yield 85.1 mg of crystalline product (90 %).

¹H-NMR: (500 MHz, CDCl₃) δ 12.52 (brs, 1H, OH), 7.41 – 7.35 (m, 1H, 7-H), 7.31 – 7.24 (m, 2H, 5-H, 6-H), 7.23 – 7.17 (m, 1H, 4-H), 6.66 (d, *J* = 9.5 Hz, 1H, 3-H), 6.12 (dd, *J* = 9.6, 5.3 Hz, 1H, 2-H), 3.29 (d, *J* = 8.8 Hz, 1H, 7b-H), 2.88 (dd, *J* = 8.8, 5.3 Hz, 1H, 1a-H), 0.78 (s, 3H, CH₃).

$^{13}\text{C-NMR}$: (126 MHz, CDCl_3) δ 184.9, 132.7, 130.7, 130.0, 129.1, 127.8, 127.7, 127.1, 123.3, 35.5, 33.3, 16.5, 7.3.

EA: (%) for $\text{C}_{13}\text{H}_{12}\text{O}_2$: calcd C, 77.98; H, 6.04; found C, 77.91; H, 6.06.

MS: (EI) m/z (%): 200 (M^+ , 48), 155 (100).

MP: 139.7 – 140.6 °C

4,7-Dichloro-2-methyl-1a,7b-dihydro-1H-cyclopropa[a]naphthalene-1-carboxylic acid
(258e)

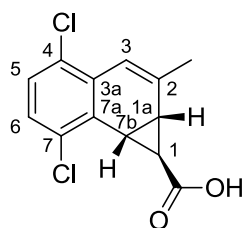

According to the general procedure catalyst **192** (3.0 mg, 14.7 μmol , 5.00 mol %), phthalazine **244r** (58.6 mg, 294 μmol , 1.00 equiv) and silyloxyfuran **257e** (68.1 mg, 368 μmol , 1.25 equiv) in diglyme (0.50 ml) were stirred for 1.5 d at 115 °C. The reaction mixture was evaporated and purified over SiO_2 (8:2 cyclohexane/ethylacetate + 1% AcOH) to yield 71.3 mg of crystalline product (90 %).

$^1\text{H-NMR}$: (500 MHz, CDCl_3) δ 11.85 (brs, 1H, OH), 7.22 – 7.14 (m, 2H, 5-H, 6-H), 6.64 (s, 1H, 3-H), 3.49 (dd, $J = 8.6, 4.1$ Hz, 1H, 7b-H), 2.61 (dd, $J = 8.7, 3.8$ Hz, 1H, 1a-H), 2.18 (d, $J = 1.5$ Hz, 3H, CH_3), 0.93 (t, $J = 3.9$ Hz, 1H, 1-H).

$^{13}\text{C-NMR}$: (126 MHz, CDCl_3) δ 181.6, 138.8, 132.8, 130.8, 130.7, 129.9, 128.5, 127.6, 117.0, 31.6, 29.4, 23.4, 21.0.

EA: (%) for $\text{C}_{13}\text{H}_{10}\text{Cl}_2\text{O}_2$: calcd C, 58.02; H, 3.75; found C, 58.24; H, 3.87.

MS: (EI) m/z (%): 268 (M^+ , 51), 223 (100).

MP: 204.9 – 206.4 °C

5.8.3 Scope of dienes

4-Fluoro-1a,7b-dihydro-1H-cyclopropa[a]naphthalene-1-carboxylic acid (258fa), *4-Fluoro-1a,7b-dihydro-1H-cyclopropa[a]naphthalene-1-carboxylic acid (258fb)*

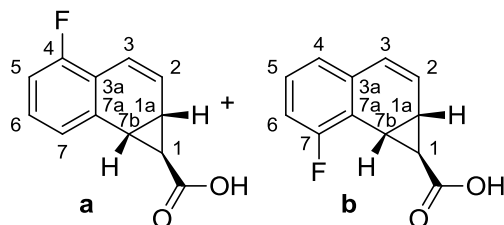

According to the general procedure catalyst **192** (3.0 mg, 14.7 μmol , 2.50 mol %), phthalazine **244c** (87.2 mg, 589 μmol , 1.00 equiv) and silyloxyfuran **275a** (115 mg, 736 μmol , 1.25 equiv) in diglyme (1.50 ml) were stirred for 1 d at 105 $^{\circ}\text{C}$. The reaction mixture was evaporated and purified over SiO_2 (7:3 cyclohexane/ethylacetate + 1% AcOH) to yield 106 mg of crystalline product (88 %, 1.1:1).

$^1\text{H-NMR}$: **a:** (500 MHz, CDCl_3) δ 11.19 (brs, 1H, OH), 7.25 – 7.22 (m, 1H, 7-H), 7.22 – 7.15 (m, 1H, 6-H), 6.97 – 6.95 (m, 1H, 5-H), 6.73 (d, $J = 9.8$ Hz, 1H, 1-H), 6.40 (dd, $J = 9.8, 5.1$ Hz, 1H, 1-H), 3.16 (ddd, $J = 8.3, 4.0, 1.1$ Hz, 1H, 7b-H), 2.82 – 2.65 (m, 1H, 1a-H), 0.93 – 0.87 (m, 1H, 1-H).

$^1\text{H-NMR}$: **b:** (500 MHz, CDCl_3) δ 11.19 (brs, 1H, OH), 7.22 – 7.15 (m, 1H, 5-H), 7.00 (ddd, $J = 9.5, 8.2, 1.1$ Hz, 1H, 6-H), 6.94 (dd, $J = 7.8, 1.4$ Hz, 1H, 4-H), 6.44 (dd, $J = 9.7, 1.9$ Hz, 1H, 3-H), 6.37 (dd, $J = 9.7, 5.0$ Hz, 1H, 2-H), 3.37 (dd, $J = 8.6, 4.0$ Hz, 1H, 7b-H), 2.82 – 2.65 (m, 1H, 1a-H), 0.93 – 0.87 (m, 1H, 1-H).

$^{13}\text{C-NMR}$: (126 MHz, CDCl_3) δ 181.8, 181.7, 161.3 (d, $J = 246.4$ Hz), 159.1 (d, $J = 249.6$ Hz), 134.2 (d, $J = 4.4$ Hz), 132.9 (d, $J = 4.4$ Hz), 128.5 (d, $J = 8.8$ Hz), 127.8 (d, $J = 8.5$ Hz), 126.6, 126.4 (d, $J = 2.3$ Hz), 125.6 (d, $J = 3.8$ Hz), 124.4 (d, $J = 3.2$ Hz), 123.5 (d, $J = 3.1$ Hz), 119.5 (d, $J = 16.3$ Hz), 118.9 (d, $J = 14.7$ Hz), 117.7 (d, $J = 6.1$ Hz), 114.4 (d, $J = 21.8$ Hz), 113.5 (d, $J = 21.4$ Hz), 30.8 (d, $J = 2.8$ Hz), 28.3, 27.3, 24.4 (d, $J = 5.6$ Hz), 22.8, 21.8.

EA: (%) for $\text{C}_{12}\text{H}_9\text{FO}_2$: calcd C, 70.58; H, 4.44; found C, 70.51; H, 4.57.

MS: (EI) m/z (%): 204 (M^+ , 33), 159 (100).

MP: 126.8 – 131.5 $^{\circ}\text{C}$

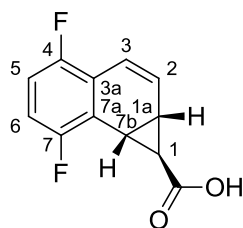
4,7-Difluoro-1a,7b-dihydro-1H-cyclopropa[a]naphthalene-1-carboxylic acid (**258g**)

According to the general procedure catalyst **192** (3.0 mg, 14.7 μmol , 2.50 mol %), phthalazine **244d** (97.8 mg, 589 μmol , 1.00 equiv) and silyloxyfuran **275a** (115 mg, 736 μmol , 1.25 equiv) in diglyme (1.50 ml) were stirred for 14 h at 95 °C. The reaction mixture was evaporated and purified over SiO_2 (8:2 cyclohexane/ethylacetate + 1% AcOH) to yield 130 mg of crystalline product (quant.).

$^1\text{H-NMR}$: (400 MHz, CDCl_3) δ 12.17 (brs, 1H, OH), 7.02 – 6.83 (m, 2H, 5-H, 6-H), 6.70 (dd, $J = 9.8, 1.9$ Hz, 1H, 3-H), 6.45 (dd, $J = 9.8, 5.1$ Hz, 1H, 2-H), 3.40 – 3.27 (m, 1H, 7b-H), 2.82 – 2.65 (m, 1H, 1a-H), 0.92 (t, $J = 3.9$ Hz, 1H, 1-H).

$^{13}\text{C-NMR}$: (101 MHz, CDCl_3) δ 181.3, 157.3 (dd, $J = 222.7, 1.9$ Hz), 154.8 (dd, $J = 226.2, 2.0$ Hz), 127.3 (d, $J = 2.4$ Hz), 120.8 (dd, $J = 18.6, 4.6$ Hz), 120.3 (dd, $J = 16.8, 4.2$ Hz), 117.5 (dd, $J = 5.3, 3.0$ Hz), 114.5 (dd, $J = 24.5, 8.9$ Hz), 113.8 (dd, $J = 24.2, 8.6$ Hz), 27.1, 24.2 (dd, $J = 4.8, 2.1$ Hz), 21.8.

$^{19}\text{F-NMR}$: (376 MHz, CDCl_3) -126.6 (d, $J = 18.7$ Hz), -127.2 (d, $J = 18.6$ Hz).

EA: (%) for $\text{C}_{12}\text{H}_8\text{F}_2\text{O}_2$: calcd C, 64.87; H, 3.63; found C, 65.00; H, 3.66.

MS: (EI) m/z (%): 222 (M^+ , 31), 177 (100).

MP: 181.7 – 182.3 °C

4-Chloro-1a,7b-dihydro-1H-cyclopropa[a]naphthalene-1-carboxylic acid (258ha), *7-Chloro-1a,7b-dihydro-1H-cyclopropa[a]naphthalene-1-carboxylic acid (258hb)*

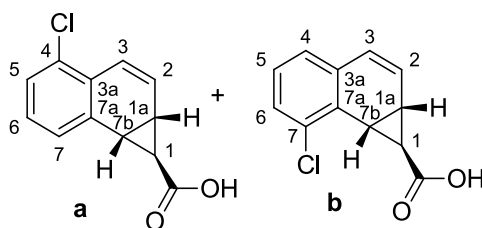

According to the general procedure catalyst **192** (3.0 mg, 14.7 μmol , 2.50 mol %), phthalazine **244e** (96.9 mg, 589 μmol , 1.00 equiv) and silyloxyfuran **275a** (115 mg, 736 μmol , 1.25 equiv) in diglyme (1.50 ml) were stirred for 1 d at 130 $^{\circ}\text{C}$. The reaction mixture was evaporated and purified over SiO_2 (7:3 cyclohexane/ethylacetate + 1% AcOH) to yield 134 mg of crystalline product (quant., 1:1.1).

$^1\text{H-NMR}$: **a:** (400 MHz, CDCl_3) δ 11.93 (brs, 1H, OH), 7.35 (d, $J = 7.5$ Hz, 1H, 5-H), 7.30 (d, $J = 7.9$ Hz, 1H, 7-H), 7.17 (t, $J = 7.7$ Hz, 1H, 6-H), 6.93 (d, $J = 9.8$ Hz, 1H, 3-H), 6.45 (dd, $J = 9.8, 5.1$ Hz, 1H, 2-H), 3.17 (dd, $J = 8.4, 4.0$ Hz, 1H, 7b-H), 2.77 (dt, $J = 8.3, 4.2$ Hz, 1H, 1a-H), 0.87 (t, $J = 3.8$ Hz, 1H, 1-H).

$^1\text{H-NMR}$: **b:** (400 MHz, CDCl_3) δ 10.97 (brs, 1H, OH), 7.33 (dd, $J = 7.9, 1.3$ Hz, 1H, 6-H), 7.18 (t, $J = 7.8$ Hz, 1H, 5-H), 7.07 (dd, $J = 7.6, 1.3$ Hz, 1H, 4-H), 6.43 (d, $J = 9.5$ Hz, 1H, 3-H), 6.37 (dd, $J = 9.6, 4.9$ Hz, 1H, 2-H), 3.52 (dd, $J = 8.6, 4.1$ Hz, 1H, 7b-H), 2.76 (dt, $J = 8.7, 4.4$ Hz, 1H, 1a-H), 0.93 (t, $J = 3.9$ Hz, 1H, 1-H).

$^{13}\text{C-NMR}$: (126 MHz, CDCl_3) δ 181.7, 181.7, 134.6, 134.3, 132.7, 132.6, 130.2, 128.5, 128.2, 128.2, 128.1, 127.7, 127.6, 127.5, 126.5, 126.5, 125.9, 121.8, 31.5, 28.7, 28.4, 28.3, 22.7, 21.4.

EA: (%) for $\text{C}_{12}\text{H}_9\text{ClO}_2$: calcd C, 65.32; H, 4.11; found C, 65.20; H, 4.28.

MS: (EI) m/z (%): 220 (M^+ , 42), 175 (100).

MP: 138.3 – 142.0 $^{\circ}\text{C}$

5-Chloro-1a,7b-dihydro-1H-cyclopropa[a]naphthalene-1-carboxylic acid (**258ia**), 6-Chloro-1a,7b-dihydro-1H-cyclopropa[a]naphthalene-1-carboxylic acid (**258ib**)

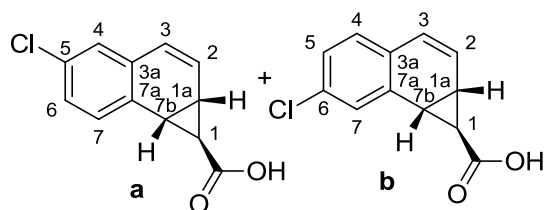

According to the general procedure catalyst **192** (3.0 mg, 14.7 μmol , 2.50 mol %), phthalazine **244f** (96.9 mg, 589 μmol , 1.00 equiv) and silyloxyfuran **275a** (138 mg, 883 μmol , 1.50 equiv) in diglyme (1.50 ml) were stirred for 3.5 d at 125 °C. The reaction mixture was evaporated and purified over SiO_2 (7:3 cyclohexane/ethylacetate + 1% AcOH) to yield 132 mg of crystalline product (quant., 1:1.3).

$^1\text{H-NMR}$: **a:** (400 MHz, CD_2Cl_2) δ 10.66 (s, 1H, OH), 7.40 (d, $J = 8.1$ Hz, 1H, 7-H), 7.23 (dd, $J = 8.1, 2.2$ Hz, 1H, 6-H), 7.17 (d, $J = 2.2$ Hz, 1H, 4-H), 6.48 – 6.39 (m, 2H, 2-H, 3-H), 3.20 – 3.06 (m, 1H, 7b-H), 2.80 – 2.66 (m, 1H, 1a-H), 0.85 (t, $J = 3.8$ Hz, 1H, 1-H).

$^1\text{H-NMR}$: **b:** (400 MHz, CD_2Cl_2) δ 10.66 (s, 1H, OH), 7.45 (d, $J = 2.2$ Hz, 1H, 7-H), 7.22 (dd, $J = 8.2, 2.2$ Hz, 1H, 5-H), 7.12 (d, $J = 8.2$ Hz, 1H, 4-H), 6.48 – 6.39 (m, 1H, 3-H), 6.36 (dd, $J = 9.6, 5.0$ Hz, 1H, 2-H), 3.20 – 3.06 (m, 1H, 7b-H), 2.80 – 2.66 (m, 1H, 1a-H), 0.87 (t, $J = 3.8$ Hz, 1H, 1-H).

$^{13}\text{C-NMR}$: (126 MHz, CD_2Cl_2) δ 181.5, 181.4, 134.1, 132.8, 132.4, 132.4, 130.8, 130.0, 129.3, 129.2, 128.6, 127.5, 127.5, 127.3, 127.1, 126.1, 125.2, 125.1, 30.8, 30.8, 28.4, 28.3, 22.7, 22.7.

HRMS: (ESI) m/z calcd for $[\text{C}_{12}\text{H}_8\text{ClO}_2]^-$: $[\text{M-H}]^-$ 219.0218; found 219.0214.

MS: (EI) m/z (%): 220 (M^+ , 33), 175 (100).

MP: 158.9 – 171.3 °C

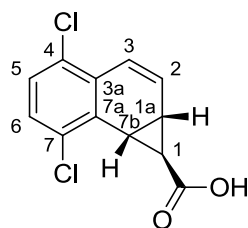
4,7-Dichloro-1a,7b-dihydro-1H-cyclopropa[a]naphthalene-1-carboxylic acid (**258j**)

According to the general procedure catalyst **192** (1.2 mg, 5.89 μmol , 2.00 mol %), phthalazine **244b** (58.6 mg, 294 μmol , 1.00 equiv) and silyloxyfuran **275a** (58.7 mg, 368 μmol , 1.25 equiv) in diglyme (0.50 ml) were stirred for 1.5 d at 80 $^{\circ}\text{C}$. The reaction mixture was evaporated and purified over SiO_2 (7:3 cyclohexane/ethylacetate + 1% AcOH) to yield 73.4 mg of crystalline product (98 %).

$^1\text{H-NMR}$: (500 MHz, CDCl_3) δ 11.85 (brs, 1H, OH), 7.26 – 7.20 (m, 2H, 5-H, 6-H), 6.88 (d, $J = 9.9$ Hz, 1H, 3-H), 6.49 (dd, $J = 9.8, 5.0$ Hz, 1H, 2-H), 3.49 (dd, $J = 8.4, 4.1$ Hz, 1H, 7b-H), 2.75 (ddd, $J = 8.7, 5.1, 3.8$ Hz, 1H, 1a-H), 0.90 (t, $J = 4.0$ Hz, 1H, 1-H).

$^{13}\text{C-NMR}$: (126 MHz, CDCl_3) δ 181.4, 133.0, 132.0, 130.9, 129.9, 128.7, 128.5 (2 C), 121.6, 28.6, 28.3, 21.5.

EA: (%) for $\text{C}_{12}\text{H}_8\text{Cl}_2\text{O}_2$: calcd C, 56.50; H, 3.16; found C, 56.63; H, 3.42.

MS: (EI) m/z (%): 254 (M^+ , 46), 209 (100).

MP: 189.1 – 191.9 $^{\circ}\text{C}$

8,8a-Dihydro-7aH-cyclopropa[7,8]naphtho[1,2-d][1,3]dioxole-8-carboxylic acid (258ka),

6,6a-Dihydro-5aH-cyclopropa[5,6]naphtho[1,2-d][1,3]dioxole-6-carboxylic acid (258kb)

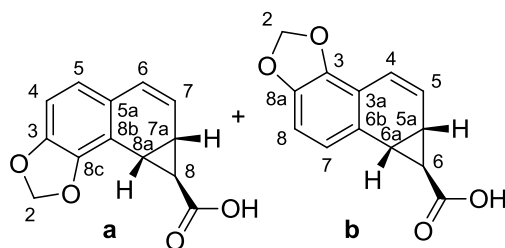

According to the general procedure catalyst **192** (5 mg, 24.5 μmol , 5.00 mol %), phthalazine **244g** (85.4 mg, 490 μmol , 1.00 equiv) and silyloxyfuran **275a** (134 mg, 858 μmol , 1.75 equiv) in diglyme (1.50 ml) were stirred for 3 d at 120 °C. The reaction mixture was evaporated and purified over SiO_2 (1:1 cyclohexane/ethylacetate + 1% AcOH) to yield 88.2 mg of crystalline product (78 %, 1:1.5).

$^1\text{H-NMR}$: **a:** (500 MHz, CDCl_3) δ 11.41 (brs, 1H, OH), 6.70 (s, 1H, 5-H), 6.66 (d, $J = 7.9$ Hz, 1H, 4-H), 6.41 – 6.29 (m, 1H, 6-H), 6.15 (dd, $J = 9.7, 5.0$ Hz, 1H, 7-H), 6.10 – 5.98 (m, 2H, 2-H), 3.20 (dd, $J = 8.5, 3.9$ Hz, 1H, 8a-H), 2.71 – 2.61 (m, 2H, 7a-H), 0.98 (t, $J = 3.8$ Hz, 1H, 8-H).

$^1\text{H-NMR}$: **b:** (500 MHz, CDCl_3) δ 11.41 (brs, 1H, OH) 6.90 (d, $J = 7.9$ Hz, 1H, 7-H), 6.73 (d, $J = 7.9$ Hz, 1H, 8-H), 6.55 (d, $J = 9.7$ Hz, 1H, 4-H), 6.41 – 6.29 (m, 1H, 5-H), 6.01 – 5.94 (m, 2H, 2-H), 3.09 (dd, $J = 8.5, 4.0$ Hz, 1H, 6a-H), 2.71 – 2.61 (m, 1H, 5a-H), 0.92 (t, $J = 3.9$ Hz, 1H, 6-H).

$^{13}\text{C-NMR}$: (126 MHz, CDCl_3) δ 181.7, 181.6, 146.9, 146.3, 146.0, 143.8, 126.1 (C 2), 125.7, 125.7, 122.8, 121.5, 121.5, 118.6, 114.2, 114.0, 107.7, 106.9, 101.4, 101.3, 30.8, 27.9, 26.9, 25.0, 23.8, 22.8.

EA: (%) for $\text{C}_{13}\text{H}_{10}\text{O}_4$: calcd C, 67.82; H, 4.38; found C, 67.71; H, 4.70.

MS: (EI) m/z (%): 230 (M^+ , 44), 185 (100).

MP: 173.4 – 179.2 °C

4,7-Dimethoxy-1a,7b-dihydro-1H-cyclopropa[a]naphthalene-1-carboxylic acid (258I)

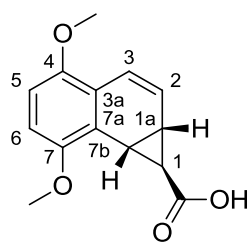

According to the general procedure catalyst **192** (5.0 mg, 24.5 μmol , 5.00 mol %), phthalazine **244h** (93.3 mg, 490 μmol , 1.00 equiv) and silyloxyfuran **275a** (153 mg, 981 μmol , 2.00 equiv) in diglyme (1.50 ml) were stirred for 11 d at 160 $^{\circ}\text{C}$. The reaction mixture was evaporated and purified over SiO_2 (1:1 cyclohexane/ethylacetate + 1% AcOH) to yield 116 mg of crystalline product (96 %).

$^1\text{H-NMR}$: (400 MHz, CDCl_3) δ 11.36 (s, 1H, OH), 6.86 (d, $J = 9.8$ Hz, 1H, 3-H), 6.81 – 6.61 (m, 2H, 5-H, 6-H), 6.32 (dd, $J = 9.9, 5.1$ Hz, 1H, 2-H), 3.84 (s, 3H, O- CH_3), 3.80 (s, 3H, O- CH_3), 3.47 (dd, $J = 8.7, 4.1$ Hz, 1H, 7b-H), 2.70 (dt, $J = 8.8, 4.3$ Hz, 1H, 1a-H), 0.79 (t, $J = 3.8$ Hz, 1H, 1-H).

$^{13}\text{C-NMR}$: (101 MHz, CDCl_3) δ 182.8, 151.9, 149.9, 125.3, 122.4, 121.2, 119.6, 109.8, 108.9, 56.1, 56.1, 28.2, 26.3, 21.8.

MS: (EI) m/z (%): 246 (M^+ , 100),

EA: (%) for $\text{C}_{14}\text{H}_{14}\text{O}_4$: calcd C, 68.28; H, 5.73; found C, 68.36; H, 5.79.

MP: 183.8 – 184.9 $^{\circ}\text{C}$

5-(Methylthio)-1a,7b-dihydro-1H-cyclopropa[a]naphthalene-1-carboxylic acid (**258ma**), 6-(Methylthio)-1a,7b-dihydro-1H-cyclopropa[a]naphthalene-1-carboxylic acid (**258mb**)

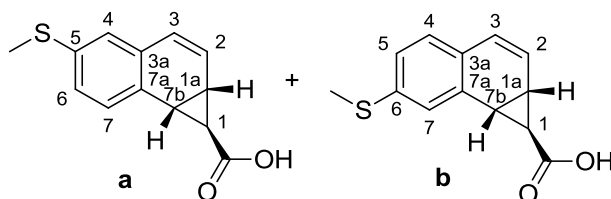

According to the general procedure catalyst **192** (4 mg, 19.6 μmol , 5.00 mol %), phthalazine **244i** (69.2 mg, 392 μmol , 1.00 equiv) and silyloxyfuran **275a** (76.6 mg, 490 μmol , 1.25 equiv) in diglyme (0.50 ml) were stirred for 3.5 d at 145 °C. The reaction mixture was evaporated and purified over SiO_2 (6:4 cyclohexane/ethylacetate + 1% AcOH) to yield 87.0 mg of crystalline product (95 %, 1.2:1).

$^1\text{H-NMR}$: **a:** (500 MHz, CDCl_3) δ 12.35 (brs, 1H, OH), 7.35 (d, $J = 7.9$ Hz, 1H, 7-H), 7.16 (dd, $J = 8.0, 2.1$ Hz, 1H, 6-H), 7.05 (d, $J = 1.5$ Hz, 1H, 4-H), 6.45 – 6.37 (m, 1H, 3-H), 6.34 (dd, $J = 9.6, 4.9$ Hz, 1H, 2-H), 3.18 – 3.07 (m, 1H, 7b-H), 2.78 – 2.68 (m, 1H, 1a-H), 2.49 (s, 3H, S- CH_3), 0.86 (t, $J = 3.8$ Hz, 1H, 1-H).

$^1\text{H-NMR}$: **b:** (500 MHz, CDCl_3) δ 12.35 (brs, 1H, OH), 7.32 (d, $J = 1.1$ Hz, 1H, 7-H), 7.12 (dd, $J = 8.1, 2.0$ Hz, 1H, 5-H), 7.07 (d, $J = 7.9$ Hz, 1H, 4-H), 6.45 – 6.37 (m, 1H, 3-H), 6.26 (dd, $J = 9.6, 5.1$ Hz, 1H, 2-H), 3.18 – 3.07 (m, 1H, 7b-H), 2.78 – 2.68 (m, 1H, 1a-H), 2.52 (s, 3H, S- CH_3), 0.89 (t, $J = 3.8$ Hz, 1H, 1-H).

$^{13}\text{C-NMR}$: (126 MHz, CDCl_3) δ 182.4, 182.3, 138.2, 137.0, 133.0, 131.3, 129.4, 129.2, 128.4, 127.8, 126.6, 126.3, 126.2, 126.1, 126.0, 125.8, 125.0, 124.8, 31.3, 31.1, 28.6, 28.4, 23.1, 23.0, 16.1, 15.8.

MS: (EI) m/z (%): 232 (M^+ , 54), 187 (100).

EA: (%) for $\text{C}_{13}\text{H}_{12}\text{O}_2\text{S}$: calcd C, 67.21; H, 5.21; found C, 67.06; H, 5.20.

MP: 115.5 – 123.4 °C

5-Methyl-1a,7b-dihydro-1H-cyclopropa[a]naphthalene-1-carboxylic acid (**258na**), 6-Methyl-1a,7b-dihydro-1H-cyclopropa[a]naphthalene-1-carboxylic acid (**258nb**)

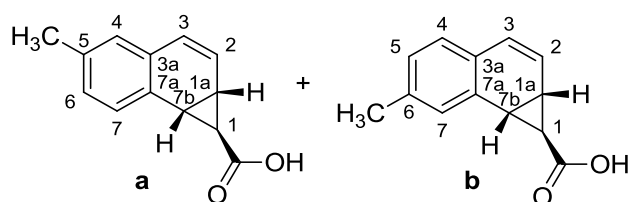

According to the general procedure catalyst **192** (2.9 mg, 14.2 μmol , 2.50 mol %), phthalazine **244j** (56.6 mg, 392 μmol , 1.00 equiv) and silyloxyfuran **275a** (76.6 mg, 490 μmol , 1.25 equiv) in diglyme (0.50 ml) were stirred for 3.5 d at 150 $^{\circ}\text{C}$. The reaction mixture was evaporated and purified over SiO_2 (7:3 cyclohexane/ethylacetate + 1% AcOH) to yield 72.6 mg of crystalline product (92 %, 1:1).

$^1\text{H-NMR}$: **a:** (500 MHz, CDCl_3) δ 12.13 (brs, 1H, OH), 7.33 (d, $J = 7.6$ Hz, 1H, 7-H), 7.11 – 7.06 (m, 1H, 6-H), 6.98 (s, 1H, 4-H), 6.40 (d, $J = 7.8$ Hz, 1H, 3-H), 6.30 (dd, $J = 9.6, 5.0$ Hz, 1H, 2-H), 3.15 (dd, $J = 8.7, 4.0$ Hz, 1H, 7b-H), 2.76 – 2.68 (m, 1H, 1a-H), 2.34 (s, 3H, CH_3), 0.85 (t, $J = 3.8$ Hz, 1H, 1-H).

$^1\text{H-NMR}$: **b:** (500 MHz, CDCl_3) δ 12.13 (brs, 1H, OH), 7.27 (s, 1H, 7-H), 7.06 – 7.04 (m, 2H, 4-H, 5-H), 6.42 (d, $J = 7.7$ Hz, 1H, 3-H), 6.25 (dd, $J = 9.6, 5.0$ Hz, 1H, 2-H), 3.13 (dd, $J = 8.7, 4.0$ Hz, 1H, 7b-H), 2.76 – 2.68 (m, 1H, 1a-H), 2.37 (s, 3H, CH_3), 0.87 (t, $J = 3.8$ Hz, 1H, 1-H).

$^{13}\text{C-NMR}$: (126 MHz, CDCl_3) δ 182.39, 182.38, 137.8, 136.7, 132.2, 130.6, 129.4, 129.4, 128.7, 128.63, 128.62, 128.1, 128.0, 127.8, 126.4, 126.2, 125.6, 124.5, 31.5, 31.3, 28.6, 28.5, 23.0, 22.9, 21.3, 21.1.

EA: (%) for $\text{C}_{13}\text{H}_{12}\text{O}_2$: calcd C, 77.98; H, 6.04; found C, 78.00; H, 5.93.

MS: (EI) m/z (%): 200 (M^+ , 32), 155 (100).

MP: 147.4 – 150.5 $^{\circ}\text{C}$

7,7a-Dihydro-6aH-cyclopropa[h]quinoline-7-carboxylic acid (**258oa**), 1a,7b-Dihydro-1H-cyclopropa[f]quinoline-1-carboxylic acid (**258ob**)

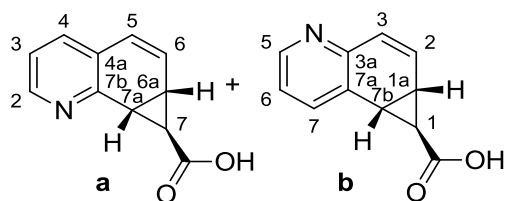

According to the general procedure catalyst **192** (6 mg, 29.4 μmol , 5.00 mol %), phthalazine **248f** (77.2 mg, 589 μmol , 1.00 equiv) and silyloxyfuran **275a** (115 mg, 736 μmol , 1.25 equiv) in diglyme (1.50 ml) were stirred for 1 d at 105 °C. The reaction mixture was evaporated and purified over SiO_2 (7:3 cyclohexane/ethylacetate + 1% AcOH) to yield 101 mg of crystalline product (92 %, 1:1.4).

$^1\text{H-NMR}$: **a:** (500 MHz, DMSO-d_6) δ 12.47 (brs, 1H, OH), 8.39 (dd, $J = 4.8, 1.7$ Hz, 1H, 2-H), 7.62 (dd, $J = 7.7, 1.7$ Hz, 1H, 4-H), 7.28 (dd, $J = 7.7, 4.9$ Hz, 1H, 3-H), 6.49 (dd, $J = 9.6, 1.1$ Hz, 1H, 5-H), 6.46 (dd, $J = 9.6, 4.6$ Hz, 1H, 6-H), 3.05 (dd, $J = 8.2, 4.1$ Hz, 1H, 7a-H), 2.67 (dddd, $J = 8.3, 4.8, 3.8, 1.1$ Hz, 1H, 6a-H), 0.72 (t, $J = 3.9$ Hz, 1H, 7-H).

$^1\text{H-NMR}$: **b:** (500 MHz, DMSO-d_6) δ 12.47 (brs, 1H, OH), 8.41 (dd, $J = 4.8, 1.7$ Hz, 1H, 5-H), 7.96 – 7.90 (m, 1H, 7-H), 7.24 (dd, $J = 7.7, 4.8$ Hz, 1H, 6-H), 6.69 (ddd, $J = 9.7, 5.2, 0.9$ Hz, 1H, 2-H), 6.52 (d, $J = 9.8$ Hz, 1H, 3-H), 3.09 (dd, $J = 7.7, 4.0$ Hz, 1H, 7b-H), 2.61 (dddd, $J = 8.1, 5.2, 3.7, 0.6$ Hz, 1H, 1a-H), 0.67 (t, $J = 3.9$ Hz, 1H, 1-H).

$^{13}\text{C-NMR}$: (126 MHz, DMSO-d_6) δ 175.8 (2C), 152.4, 149.6, 148.5, 148.1, 136.7, 135.1, 132.2, 128.8, 128.2, 127.6, 126.0, 124.6, 122.84, 122.75, 32.1, 29.2, 28.1, 27.0, 22.8, 21.8.

MS: (EI) m/z (%): 187 (M^+ , 36), 142 (100).

HRMS: (ESI) m/z calcd for $[\text{C}_{11}\text{H}_8\text{NO}_2]$: $[\text{M-H}]^-$ 186.0561; found 186.0557.

MP: 204.7 – 212.8 °C (dec. 220 °C).

1a,9a-Dihydro-1H-cyclopropa[a]phenanthrene-1-carboxylic acid (258pa), *1a,9c-Dihydro-1H-cyclopropa[c]phenanthrene-1-carboxylic acid (258pb)*

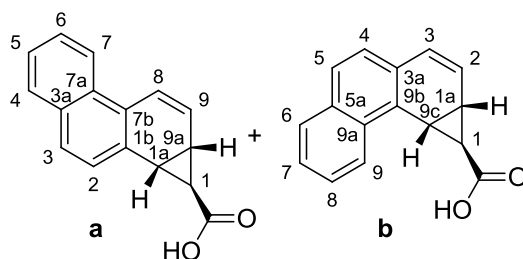

According to the general procedure catalyst **192** (3.0 mg, 14.7 μmol , 2.50 mol %), phthalazine **244I** (106 mg, 589 μmol , 1.00 equiv) and silyloxyfuran **275a** (138 mg, 883 μmol , 1.5 equiv) in diglyme (1.50 ml) were stirred for 3 d at 160 $^{\circ}\text{C}$. The reaction mixture was evaporated and purified over SiO_2 (7:3 cyclohexane/ethylacetate + 1% AcOH) to yield 115 mg of crystalline product (83 % 2:1).

$^1\text{H-NMR}$: **a:** (500 MHz, CDCl_3) δ 11.96 (s, 1H, OH), 8.20 (d, $J = 8.3$ Hz, 1H, 7-H), 7.89 – 7.82 (m, 1H, 4-H), 7.78 (d, $J = 8.3$ Hz, 1H, 3-H), 7.59 (d, $J = 8.4$ Hz, 1H, 2-H), 7.57 – 7.51 (m, 1H, 6-H), 7.48 (ddd, $J = 8.0, 6.8, 1.2$ Hz, 1H, 5-H), 7.34 (d, $J = 9.9$ Hz, 1H, 8-H), 6.57 (dd, $J = 9.8, 5.1$ Hz, 1H, 9-H), 3.38 (dd, $J = 8.3, 3.8$ Hz, 1H, 1a-H), 2.97 – 2.89 (m, 1H, 9a-H), 0.83 (t, $J = 3.7$ Hz, 1H, 1-H).

$^1\text{H-NMR}$: **b:** (500 MHz, CDCl_3) δ 11.96 (s, 1H, OH), 8.27 (d, $J = 8.3$ Hz, 1H, 9-H), 7.89 – 7.82 (m, 1H, 6-H), 7.74 (d, $J = 8.2$ Hz, 1H, 5-H), 7.62 (ddd, $J = 8.4, 6.8, 1.4$ Hz, 1H, 8-H), 7.57 – 7.51 (m, 1H, 7-H), 7.31 (d, $J = 8.3$ Hz, 1H, 4-H), 6.61 (d, $J = 9.4$ Hz, 1H, 3-H), 6.47 (dd, $J = 9.5, 5.0$ Hz, 1H, 2-H), 3.81 (dd, $J = 8.8, 4.1$ Hz, 9c-H), 2.97 – 2.89 (m, 1a-H), 0.88 (t, $J = 4.0$ Hz, 1H, 1-H).

$^{13}\text{C-NMR}$: (126 MHz, CDCl_3) δ 183.2, 182.6, 133.2, 132.9, 131.9, 130.3, 130.1, 128.7, 128.6 (2 C), 128.02, 127.96, 127.3, 127.1, 127.09, 126.8, 126.6, 126.5, 126.4, 126.0, 125.9, 125.8, 125.5, 123.3, 122.5, 120.9, 33.2, 29.74, 29.65, 27.5, 22.2, 20.2.

HRMS: (ESI) m/z calcd for $[\text{C}_{16}\text{H}_{11}\text{O}_2]^-$: $[\text{M-H}]^-$ 235.0765; found 235.0760.

MS: (EI) m/z (%): 236 (M^+ , 50), 191 (27).

MP: 145.3 – 148.8 $^{\circ}\text{C}$.

Triisopropylsilyl-4-fluoro-1a,7b-dihydro-1H-cyclopropa[a]naphthalene-1-carboxylate (258qa), *Triisopropylsilyl-7-fluoro-1a,7b-dihydro-1H-cyclopropa[a]naphthalene-1-carboxylate (258qb)*

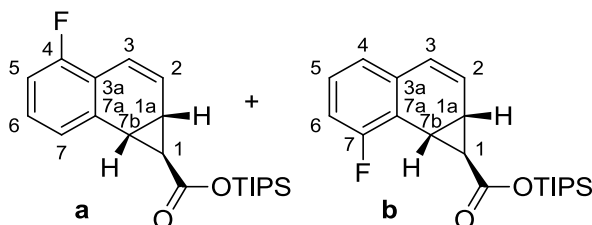

According to the general procedure catalyst **192** (1.5 mg, 7.4 μmol , 2.50 mol %), phthalazine **244c** (43.6 mg, 294 μmol , 1.00 equiv) and silyloxyfuran **257c** (88.4 mg, 368 μmol , 1.25 equiv) in diglyme (0.50 ml) were stirred for 1 d at 130 °C. The reaction mixture was evaporated and purified over SiO_2 (cyclohexane \rightarrow cyclohexane + 1% ethylacetate) to yield 102 mg of liquid product (96 %, 1.3:1).

$^1\text{H-NMR}$: **a:** (500 MHz, CDCl_3) δ 7.23 – 7.11 (m, 2H, 6-H, 7-H), 7.01 – 6.89 (m, 1H, 5-H), 6.70 (d, $J = 9.8$ Hz, 1H, 3-H), 6.44 – 6.31 (m, 1H, 2-H), 3.07 (dd, $J = 8.3$, 4.0 Hz, 1H, 7b-H), 2.70 – 2.59 (m, 1H, 1a-H), 1.37 – 1.27 (m, 3H, SiCH), 1.15 – 1.06 (m, 18H, CH_3), 0.91 – 0.86 (m, 1H, 1-H).

$^1\text{H-NMR}$: **b:** (500 MHz, CDCl_3) δ 7.23 – 7.11 (m, 1H, 5-H), 7.01 – 6.89 (m, 2H, 4-H, 6-H), 6.44 – 6.31 (m, 2H, 2-H, 3-H), 3.28 (dd, $J = 8.5$, 4.0 Hz, 1H, 7b-H), 2.70 – 2.59 (m, 1H, 1a-H), 1.37 – 1.27 (m, 3H, SiCH), 1.15 – 1.06 (m, 18H, CH_3), 0.91 – 0.86 (m, 1H, 1-H).

$^{13}\text{C-NMR}$: (126 MHz, CDCl_3) δ 174.93, 174.85, 161.3 (d, $J = 246.4$ Hz), 159.1 (d, $J = 249.4$ Hz), 134.7 (d, $J = 4.3$ Hz), 132.9 (d, $J = 4.0$ Hz), 128.3 (d, $J = 8.9$ Hz), 127.4 (d, $J = 8.3$ Hz), 127.1, 126.8 (d, $J = 2.4$ Hz), 125.2 (d, $J = 3.9$ Hz), 124.3 (d, $J = 3.3$ Hz), 123.3 (d, $J = 3.1$ Hz), 120.0 (d, $J = 16.3$ Hz), 118.9 (d, $J = 14.9$ Hz), 117.2 (d, $J = 6.0$ Hz), 114.2 (d, $J = 21.5$ Hz), 113.3 (d, $J = 21.4$ Hz), 30.4 (d, $J = 2.8$ Hz), 27.8, 26.6, 24.1, 24.0 (d, $J = 5.8$ Hz), 23.1, 17.8 (d, $J = 2.6$ Hz, 12 C), 12.0 (6 C).

EA: (%) for $\text{C}_{21}\text{H}_{29}\text{FO}_2\text{Si}$: calcd C, 69.96; H, 8.11; found C, 69.99; H, 8.06.

MS: (EI) m/z (%): 360 (M^+ , 1), 317 (100).

Triisopropylsilyl-4-chloro-1a,7b-dihydro-1H-cyclopropa[a]naphthalene-1-carboxylate (258ra), *Triisopropylsilyl-7-chloro-1a,7b-dihydro-1H-cyclopropa[a]naphthalene-1-carboxylate (258rb)*

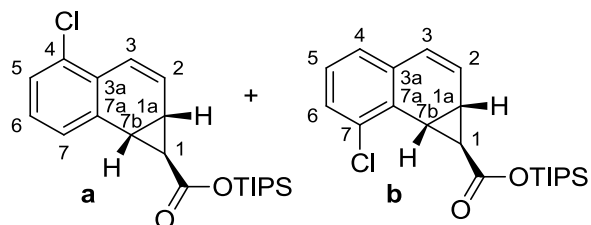

According to the general procedure catalyst **192** (1.5 mg, 7.4 μmol , 2.50 mol %), phthalazine **244e** (48.4 mg, 294 μmol , 1.00 equiv) and silyloxyfuran **257c** (88.4 mg, 368 μmol , 1.25 equiv) in diglyme (0.50 ml) were stirred for 1 d at 135 °C. The reaction mixture was evaporated and purified over SiO_2 (cyclohexane \rightarrow cyclohexane + 1% ethylacetate) to yield 110 mg of liquid product (99 %, 1.1:1).

$^1\text{H-NMR}$: **a:** (500 MHz, CDCl_3) δ 7.33 (d, $J = 7.6$ Hz, 1H, 7-H), 7.32 – 7.26 (m, 1H, 5-H), 7.17 (t, $J = 7.8$ Hz, 1H, 6-H), 6.93 (d, $J = 9.8$ Hz, 1H, 3-H), 6.47 (dd, $J = 9.8, 5.1$ Hz, 1H, 2-H), 3.10 (dd, $J = 8.3, 4.0$ Hz, 1H, 7b-H), 2.75 – 2.64 (m, 1H, 1a-H), 1.41 – 1.29 (m, 3H, SiCH), 1.23 – 1.04 (m, 18H, CH_3), 0.88 (t, $J = 3.8$ Hz, 1H, 1-H).

$^1\text{H-NMR}$: **b:** (500 MHz, CDCl_3) δ 7.32 – 7.26 (m, 1H, 6-H), 7.14 (t, $J = 7.8$ Hz, 1H, 5-H), 7.04 (d, $J = 7.5$ Hz, 1H, 4-H), 6.39 (d, $J = 9.6$ Hz, 1H, 3-H), 6.39 (dd, $J = 9.7, 4.5$ Hz, 1H, 2-H), 3.42 (dd, $J = 8.5, 4.1$ Hz, 1H, 7b-H), 2.75 – 2.64 (m, 1H, 1a-H), 1.41 – 1.29 (m, 3H, SiCH), 1.23 – 1.04 (m, 18H, CH_3), 0.91 (t, $J = 3.9$ Hz, 1H, 1-H).

$^{13}\text{C-NMR}$: (126 MHz, CDCl_3) δ 174.87, 174.84, 134.7, 134.5, 132.7, 132.5, 130.6, 128.3, 128.2, 128.1, 128.0, 127.8, 127.36, 127.35, 126.9, 126.4, 125.5, 121.3, 31.1, 28.1, 28.1, 27.4, 24.1, 22.8, 17.8 (6 C), 17.8 (6 C), 11.98 (3 C), 11.95 (3 C).

EA: (%) for $\text{C}_{21}\text{H}_{29}\text{ClO}_2\text{Si}$: calcd C, 66.90; H, 7.75; found C, 66.84; H, 7.57.

MS: (EI) m/z (%): 376 (M^+ , 1), 333 (100).

Triisopropylsilyl-4,7-dichloro-1a,7b-dihydro-1H-cyclopropa[a]naphthalene-1-carboxylate
(258s)

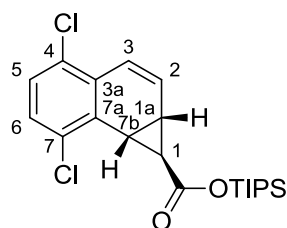

According to the general procedure catalyst **192** (1.5 mg, 7.4 μmol , 2.50 mol %), phthalazine **244b** (58.6 mg, 294 μmol , 1.00 equiv) and silyloxyfuran **257c** (88.4 mg, 368 μmol , 1.25 equiv) in diglyme (0.50 ml) were stirred for 1 d at 90 °C. The reaction mixture was evaporated and purified over SiO_2 (cyclohexane \rightarrow cyclohexane + 1% ethylacetate) to yield 110 mg of liquid product (91 %).

$^1\text{H-NMR}$: (500 MHz, CDCl_3) δ 7.23 – 7.16 (m, 2H, 5-H, 6-H), 6.83 (d, $J = 9.9$ Hz, 1H, 3-H), 6.48 (dd, $J = 9.9, 5.1$ Hz, 1H, 2-H), 3.42 – 3.37 (m, 1H, 7b-H), 2.68 (ddd, $J = 8.7, 5.2, 3.8$ Hz, 1H, 1a-H), 1.39 – 1.27 (m, 3H, SiCH), 1.17 – 1.05 (m, 18H, CH_3), 0.88 (t, $J = 3.9$ Hz, 1H, 1-H).

$^{13}\text{C-NMR}$: (126 MHz, CDCl_3) δ 174.3, 133.0, 132.4, 130.8, 129.9, 129.1, 128.5, 128.2, 121.2, 28.4, 27.5, 22.7, 17.8 (6 C), 12.0 (3 C).

EA: (%) for $\text{C}_{21}\text{H}_{28}\text{Cl}_2\text{O}_2\text{Si}$: calcd C, 61.30; H, 6.86; found C, 61.56; H, 7.02.

MS: (FAB) m/z (%): 411 ($[\text{M}+\text{H}]^+$, 37), 367 (100).

Methyl-7,7a-dihydro-6aH-cyclopropa[h]quinoline-7-carboxylate (258ta), *Methyl 1a,7b-dihydro-1H-cyclopropa[f]quinoline-1-carboxylate (258tb)*

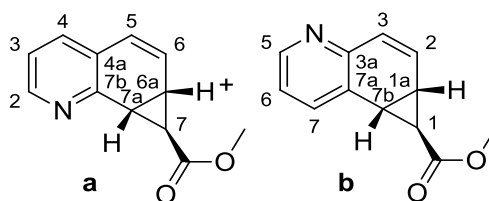

According to the general procedure catalyst **192** (9.9 mg, 48.4 μmol , 5.00 mol %), phthalazine **244k** (127 mg, 968 μmol , 1.00 equiv) and methoxyfuran **257b** (118 mg, 1.21 mmol, 1.25 equiv) in diglyme (1.50 ml) were stirred for 12 h at 120 °C. The reaction mixture was evaporated and purified over SiO_2 (6:4 cyclohexane/ethylacetate) to yield 177 mg of liquid product (91 %, 1:1.1).

$^1\text{H-NMR}$: **a:** (500 MHz, CDCl_3) δ 8.42 (dd, $J = 4.9, 1.7$ Hz, 1H, 2-H), 7.41 (dd, $J = 7.7, 1.7$ Hz, 1H, 4-H), 7.16 (dd, $J = 7.7, 4.9$ Hz, 1H, 3-H), 6.41 – 6.31 (m, 2H, 5-H, 6-H), 3.72 (s, 3H, CH_3), 3.31 (dd, $J = 8.3, 4.1$ Hz, 1H, 7a-H), 2.76 (dtd, $J = 8.2, 4.0, 1.4$ Hz, 2H, 1a-H), 0.94 (t, $J = 4.0$ Hz, 1H, 1-H).

$^1\text{H-NMR}$: **b:** (500 MHz, CDCl_3) δ 8.46 (dd, $J = 4.8, 1.7$ Hz, 1H, 5-H), 7.70 (dd, $J = 7.7, 1.7$ Hz, 1H, 7-H), 7.14 (dd, $J = 7.7, 4.8$ Hz, 1H, 6-H), 6.63 (d, $J = 9.5$ Hz, 1H, 3-H), 6.60 (dd, $J = 9.9, 4.5$ Hz, 1H, 2-H), 3.75 (s, 3H, CH_3), 3.07 (dd, $J = 8.2, 4.1$ Hz, 1H, 7b-H), 2.69 (dddd, $J = 8.3, 4.7, 3.7, 1.1$ Hz, 1H, 1a-H), 0.90 (t, $J = 3.9$ Hz, 1H, 1-H).

$^{13}\text{C-NMR}$: (126 MHz, CDCl_3) δ 175.3, 174.9, 152.6, 149.8, 148.2, 148.0, 136.1, 134.6, 131.1, 128.4, 128.0, 127.7, 125.9, 124.4, 122.2 (2 C), 52.4, 52.3, 32.6, 29.8, 28.3, 27.4, 22.7, 22.0.

HRMS: (ESI) m/z calcd for $[\text{C}_{12}\text{H}_{12}\text{NO}_2]^+$: $[\text{M}+\text{H}]^+$ 202.0863; found 202.0860.

MS: (EI) m/z (%): 201 (M^+ , 28), 142 (100).

5.8.4 Enantioselective catalysis

5,10-Dihydroboranthrene (**287**)

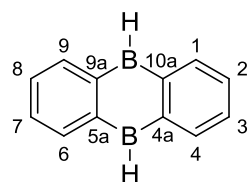

A suspension of dichlorodihydroboranthrene **189** (228 mg, 932 μmol , 1.00 equiv) and triethylsilane (271 mg, 2.33 mmol, 2.50 equiv) in DCE was sonicated for 1 h at 50 $^{\circ}\text{C}$ and stirred for 15 h at room temperature. The obtained reaction mixture was evaporated at 10^{-2} mbar to obtain white powder (160 mg, 98%). The product is insoluble in common deuterated solvents and not analyzable by standard techniques. A solid state structure was obtained by Wagner and co-workers.³² Reaction of dihydroboranthrene **287** (5.00 mg, 28.4 μmol , 1.00 equiv) with 3,3-dimethylbut-1-yne (9.34 mg, 114 μmol , 4.00 equiv) in C_6D_6 (0.5 ml) cleanly yielded the hydroboration product ($^1\text{H-NMR}$) as reported by Wagner and co-workers.³³

Methyl-1a,7b-dihydro-1H-cyclopropa[a]naphthalene-1-carboxylate (**258b**)

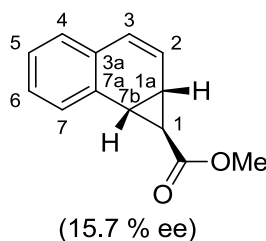

Dihydroboranthrene **287** (3.9 mg, 22.2 μmol , 0.05 equiv) and (-)- β -pinene **291** (7.56 mg, 55.5 μmol , 0.125 equiv) were stirred in C_6D_6 (0.50 ml) at rt to give a colloidal solution, which was evaporated and dissolved in diglyme (0.50 ml). Phthalazine (**244a**) (58.7 mg, 451 μmol , 1.00 equiv) and methoxyfuran **257b** (66.4 mg, 677 μmol , 1.5 equiv) were added and the reaction mixture was stirred for 2.5 d at 160 $^{\circ}\text{C}$. The reaction mixture was evaporated and purified over SiO_2 (19:1 cyclohexane/ethylacetate) to yield 18.9 mg of liquid product (21%). Recorded $^1\text{H-NMR}$ spectrum is in accordance with the above obtained one.

Chiral HPLC Chromatogram:

Analysis Date & Time : 3/30/2011 2:58:24 PM
 User Name : Admin
 Vial# : 1
 Sample Name : SIK4-154-01
 Sample ID : SIK4-154-01
 Sample Type : Unknown
 Injection Volume : 1.00
 ISTD Amount :

Data Name : D:\DATA\Simon\SIK4-154-01b.gcd
 Method Name : D:\DATA\Simon\B-DIETILTertButilsilii-086.gcm
 [Description]
 Diert-butyl silyl b-086, 90C-1C/min to 180 10 min 90 kpa
 Intensity

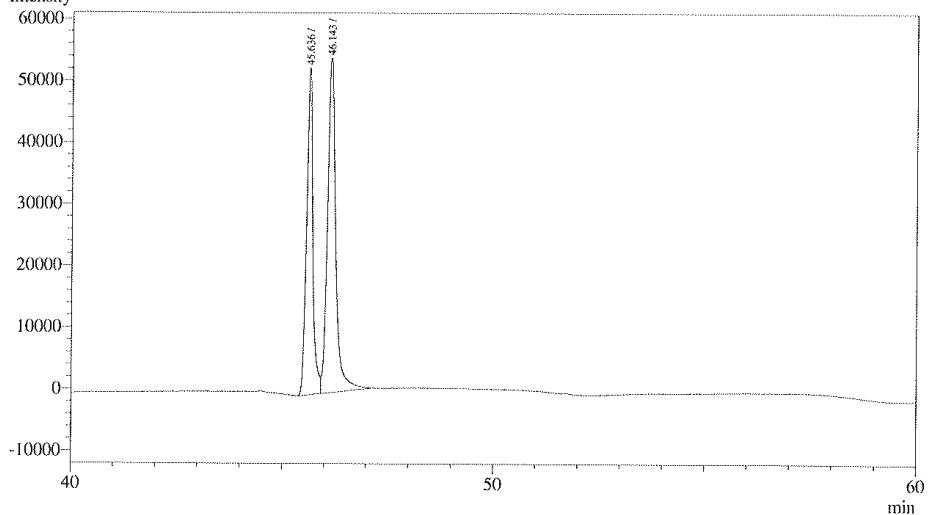

| Peak# | Ret. Time | Area | Height | Conc. | Unit | Mark | ID# | Cmpd Name |
|-------|-----------|---------|--------|--------|------|------|-----|-----------|
| 1 | 45.636 | 546267 | 52929 | 42.159 | | | | |
| 2 | 46.143 | 749475 | 54228 | 57.841 | | SV | | |
| Total | | 1295742 | 107157 | | | | | |

5.9 Domino IEDDA/[1,9]-sigmatropic rearrangement

4-Hexyl-2,3-dihydrofuran (**292a**)

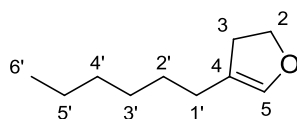

To a stirred solution of lactone **294** (2.00 g, 11.7 mmol, 1.00 equiv) was added 1M DIBAL-H in DCM (12.9 ml, 12.9 mmol, 1.10 equiv) at $-78\text{ }^{\circ}\text{C}$ over 20 min. After stirring for 15 min the reaction mixture was warmed to $-30\text{ }^{\circ}\text{C}$, stirred for 50 min at -30 to $-20\text{ }^{\circ}\text{C}$ and quenched with MeOH (1.60 ml, 38.8 mmol, 3.30 equiv). After stirring for 15 min the mixture was allowed to warm to rt and stirred for 30 min, quenched with saturated aqueous NaHCO_3 (15 ml), separated and extracted with DCM (15 ml), pre-dried with brine (10 ml), dried over Na_2SO_4 , and evaporated to afford colorless oil (2.049 g). A stirred solution of the oil in CH_2Cl_2 (50 ml) at $-50\text{ }^{\circ}\text{C}$ was treated with Et_3N (6.50 ml, 47 mmol, 4.00 equiv) followed by methanesulfonyl chloride (1.18 g, 15.3 mmol, 1.30 equiv). The solution was stirred for 1 h at $-50\text{ }^{\circ}\text{C}$, warmed to rt and heated at reflux for 14 h. The reaction mixture was then cooled to rt, filtered over 3 cm SiO_2 (slurry 3% TEA in cyclohexane), eluted with solvent (1:4 ethylacetate/cyclohexane + 1% TEA, 100 ml) and evaporated. The concentrate was bulb-tube distilled to obtain colorless oil (830 mg, 46%).

$^1\text{H-NMR}$: (400 MHz, C_6D_6) δ 6.07 – 5.98 (m, 1H, 5-H), 4.28 (t, $J = 9.5$ Hz, 2H, 2-H), 2.57 – 2.45 (m, 2H, 3-H), 2.07 – 1.97 (m, 2H, 1'-H), 1.47 – 1.15 (m, 8H, 2'-H, 3'-H, 4'-H, 5'-H), 0.87 (t, $J = 7.2$ Hz, 3H, 6'-H).

(3a,9b)-3a-Hexyl-2,3,3a,9b-tetrahydronaphtho[1,2-b]furan (**296a**)

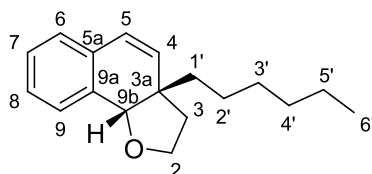

Catalyst **192** (4.0 mg, 19.6 μmol , 5.00 mol %) and phthalazine **244a** (51.1 mg, 392 μmol , 1.00 equiv) in diglyme (0.50 ml) were thoroughly stirred for 1 min. Hexyldihydrofuran **292a** (84.1 mg, 490 μmol , 1.25 equiv) was added, the reaction mixture was stirred for 1 d at $160\text{ }^{\circ}\text{C}$,

evaporated and purified over SiO₂ (15 g, 1:19 ethylacetate/cyclohexane) to yield 19.4 mg of liquid product (19 %).

¹H-NMR: (500 MHz, CDCl₃) δ 7.36 – 7.32 (m, 1H, 9-H), 7.29 (td, *J* = 7.4, 1.4 Hz, 1H, 7-H), 7.23 (td, *J* = 7.4, 1.4 Hz, 1H, 8-H), 7.16 – 7.12 (m, 1H, 6-H), 6.49 (d, *J* = 9.7 Hz, 1H, 5-H), 5.72 (dd, *J* = 9.7, 1.1 Hz, 1H, 4-H), 4.47 (s, 1H, 9b-H), 3.91 (dt, *J* = 8.1, 6.2 Hz, 1H, 2-H), 3.71 (q, *J* = 8.1 Hz, 1H, 2-H), 2.13 (dd, *J* = 7.9, 6.1 Hz, 2H, 3-H), 1.53 – 1.44 (m, 2H, 1'-H), 1.31 – 1.10 (m, 8H, 2'-H, 3'-H, 4'-H, 5'-H), 0.84 (t, *J* = 7.0 Hz, 3H, 6'-H).

¹³C-NMR: (126 MHz, CDCl₃) δ 134.1, 132.6, 132.2, 129.8, 128.8, 127.5, 126.8, 126.1, 82.6, 66.6, 47.1, 40.1, 38.7, 31.6, 30.0, 25.0, 22.6, 14.1.

MS: (EI) *m/z* (%): 256 (M⁺, 12), 171 (100).

4-Hexyl-5-(methylthio)-2,3-dihydrofuran (297a)

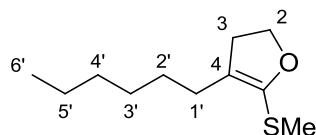

A solution of 1.6M *t*-BuLi in pentane (1.94 ml, 3.11 mmol, 1.20 equiv) was added drop wise over 10 min to a solution of hexyldihydrofuran **292a** (400 mg, 2.59 mmol, 1.00 equiv) in dry THF (1 ml) at –78 °C and stirred for 35 min. The resulting yellow suspension was slowly allowed to warm to 0 °C over 10 min and stirred for another 30 min. The mixture was cooled to –50 °C and (MeS)₂ (281 μL, 3.11 mmol, 1.20 equiv) was added over 15 min. The mixture was slowly allowed to warm to rt and stirred for 14 h. Evaporation of solvents and bulb-tube distillation (0.2 mbar/100 °C) gave a colorless oil (398 mg, 77%).

¹H-NMR: (400 MHz, CDCl₃) δ 4.27 (t, *J* = 9.3 Hz, 2H, 2-H), 2.61 (tt, *J* = 9.3, 1.1 Hz, 2H, 3-H), 2.23 (s, 3H, SMe), 2.16 (t, *J* = 7.6 Hz, 2H, 1'-H), 1.42 – 1.19 (m, 8H, 2'-H, 3'-H, 4'-H, 5'-H), 0.88 (t, *J* = 6.8 Hz, 3H, 6'-H).

^{13}C -NMR: ^{13}C NMR (101 MHz, CDCl_3) δ 144.1, 116.1, 68.4, 33.3, 31.7, 28.8, 28.1, 27.0, 22.7, 15.3, 14.1.

MS: (EI) m/z (%): 200 (M^+ , 8), 129 (100).

(3*a*,9*b*)-6,9-Difluoro-3*a*-hexyl-4-(methylthio)-2,3,3*a*,9*b*-tetrahydronaphtho[1,2-*b*]furan
(**298a**)

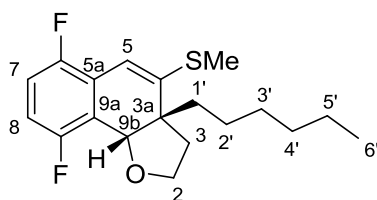

Catalyst **192** (2.5 mg, 12.3 μmol , 5.00 mol %) and difluorophthalazine **244s** (40.7 mg, 245 μmol , 1.00 equiv) in diglyme (0.50 ml) were thoroughly stirred for 1 min. methylthiodihydrofuran **297a** (61.4 mg, 307 μmol , 1.25 equiv) was added, the reaction mixture was stirred for 1.5 d at 125 $^\circ\text{C}$, evaporated and purified over SiO_2 (15 g, 1:19 ethylacetate/cyclohexane) to yield 67.8 mg of liquid product (95 %).

^1H NMR: (500 MHz, CDCl_3) δ 6.96 (td, $J = 9.1, 4.3$ Hz, 1H, 7-H), 6.83 (td, $J = 8.7, 4.1$ Hz, 1H, 8-H), 6.34 (d, $J = 1.8$ Hz, 1H, 5-H), 4.82 (d, $J = 0.7$ Hz, 1H, 9*b*-H), 3.94 (td, $J = 8.2, 3.6$ Hz, 1H, 2-H), 3.72 (ddd, $J = 9.2, 8.2, 6.4$ Hz, 1H, 2-H), 2.63 (ddd, $J = 12.7, 6.4, 3.6$ Hz, 1H, 3-H), 2.42 (s, 3H), 2.16 (ddd, $J = 12.7, 9.2, 8.2$ Hz, 1H, 3-H), 1.88 (ddd, $J = 13.4, 12.5, 3.8$ Hz, 1H, 1'-H) 1.45 (ddd, $J = 13.6, 11.7, 4.5$ Hz, 1H, 1'-H), 1.24 – 1.03 (m, 7H, 2'-H, 3'-H, 4'-H, 5'-H), 1.01 – 0.90 (m, 1H, 5'-H), 0.82 (t, $J = 7.0$ Hz, 3H, 6'-H).

^{13}C NMR: (126 MHz, CDCl_3) δ 157.1 (d, $J = 249.5$ Hz), 153.5 (d, $J = 234.36$ Hz), 146.3, 122.2, 119.3, 116.2, 113.4, 108.7, 76.2, 66.4, 51.2, 39.8, 39.2, 31.5, 29.7, 24.5, 22.6, 14.5, 14.0.

EA: (%) for $\text{C}_{19}\text{H}_{24}\text{F}_2\text{OS}$: calcd C, 67.42; H, 7.15; found C, 66.99; H, 7.09.

MS: (EI) m/z (%): 338 (M^+ , 100).

5.10 Calculations

5.10.1 General information

The DFT calculations³³ have been conducted with the exchange-correlation functional B3LYP and the Gaussian basis set 6-31(d,p). Consecutive frequency calculations were made to check for the absence of imaginary frequencies or in the case of a transition structure for the existence of only one imaginary frequency.

The Transition state calculations used the *Synchronous Transit-Guided Quasi-Newton* (STQN) Method via QST2 keyword. And the intrinsic reaction coordinate calculations to connect starting material and product have been executed by using the IRC keyword with stepsize = 10 and scf=(tight, direct).

5.10.2 Complexation of phthalazine

Phthalazine (183)

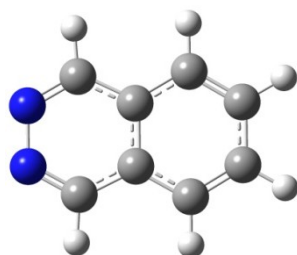

Cartesian coordinates of optimized structure:

| | | | |
|---|-------------|-------------|-------------|
| N | 2.43845600 | 0.68482300 | -0.00007100 |
| C | 1.29410900 | 1.32887500 | -0.00012800 |
| C | 0.01180700 | -0.70881700 | 0.00006700 |
| C | 1.29410900 | -1.32887500 | 0.00012100 |
| N | 2.43845600 | -0.68482300 | 0.00005700 |
| C | 0.01180700 | 0.70881700 | -0.00006700 |
| C | -1.21609600 | 1.41135900 | -0.00012900 |
| C | -2.40262800 | 0.70804700 | -0.00006000 |

| | | | |
|---|-------------|-------------|-------------|
| C | -1.21609600 | -1.41135900 | 0.00013600 |
| C | -2.40262800 | -0.70804700 | 0.00007400 |
| H | 1.36827100 | 2.41590900 | -0.00023000 |
| H | 1.36827100 | -2.41590900 | 0.00022200 |
| H | -1.21129800 | 2.49771300 | -0.00023100 |
| H | -3.34932100 | 1.23981700 | -0.00010700 |
| H | -1.21129800 | -2.49771300 | 0.00023800 |
| H | -3.34932100 | -1.23981700 | 0.00012700 |

Complex of Phthalazine (**183**) and 5,10-Dimethyl-5,10-dihydroboranthrene (**192**)

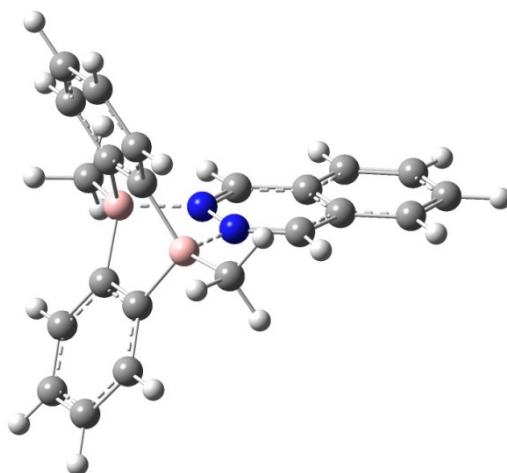

Cartesian coordinates of optimized structure:

| | | | |
|---|-------------|-------------|-------------|
| C | -2.72210300 | -3.48755700 | -0.69724500 |
| C | -2.16477100 | -2.41019100 | -1.39440500 |
| C | -1.62331300 | -1.31889200 | -0.70590800 |
| C | -1.62329300 | -1.31871900 | 0.70624200 |
| C | -2.16473400 | -2.40987800 | 1.39498800 |
| C | -2.72207900 | -3.48740000 | 0.69808000 |
| C | -1.62328300 | 1.31891500 | 0.70590500 |
| C | -1.62324500 | 1.31874300 | -0.70624500 |
| C | -2.16466300 | 2.40991000 | -1.39499600 |
| C | -2.72199800 | 3.48744000 | -0.69809000 |
| C | -2.72203800 | 3.48759600 | 0.69723300 |
| C | -2.16472900 | 2.41022000 | 1.39439800 |
| N | 0.54504700 | -0.00016600 | -0.68364400 |
| C | 1.68276000 | -0.00046000 | -1.34486800 |
| C | 2.94881700 | 0.00030900 | 0.71043500 |
| C | 1.68275500 | 0.00041700 | 1.34487300 |
| N | 0.54504500 | 0.00013400 | 0.68364800 |
| C | 2.94881900 | -0.00034900 | -0.71042700 |

| | | | |
|---|-------------|-------------|-------------|
| C | 4.17466000 | -0.00071600 | -1.41451800 |
| C | 5.35992600 | -0.00038100 | -0.70798500 |
| C | 4.17465700 | 0.00068200 | 1.41452800 |
| C | 5.35992500 | 0.00035300 | 0.70799600 |
| B | -0.98055500 | 0.00016800 | 1.39809700 |
| B | -0.98054000 | -0.00016300 | -1.39809600 |
| C | -0.80381300 | 0.00032900 | 2.99932400 |
| C | -0.80378200 | -0.00033700 | -2.99932000 |
| H | -3.15350500 | -4.32423000 | -1.24186900 |
| H | -2.16638100 | -2.42317200 | -2.48246200 |
| H | -2.16631200 | -2.42264600 | 2.48304800 |
| H | -3.15344200 | -4.32396000 | 1.24290800 |
| H | -2.16622800 | 2.42268200 | -2.48305600 |
| H | -3.15334400 | 4.32400600 | -1.24292400 |
| H | -3.15342700 | 4.32427700 | 1.24185500 |
| H | -2.16635300 | 2.42319800 | 2.48245500 |
| H | 1.58496700 | -0.00070200 | -2.42333000 |
| H | 1.58496100 | 0.00064300 | 2.42333500 |
| H | 4.17050200 | -0.00125900 | -2.50002400 |
| H | 6.30603200 | -0.00067100 | -1.23960600 |
| H | 4.17049900 | 0.00122900 | 2.50003400 |
| H | 6.30602900 | 0.00064800 | 1.23962000 |
| H | -0.29366000 | 0.88819500 | 3.39906100 |
| H | -1.80091400 | 0.00023100 | 3.45554600 |
| H | -0.29348800 | -0.88742600 | 3.39911300 |
| H | -0.29344200 | 0.88740600 | -3.39911600 |
| H | -0.29363300 | -0.88821400 | -3.39903900 |
| H | -1.80087900 | -0.00023600 | -3.45555200 |

Complex of methylchloropyridazine **218** and 5,10-Dimethyl-5,10-dihydroboranthrene (**182**)

Cartesian coordinates of optimized structure:

| | | | |
|---|-------------|-------------|-------------|
| C | -2.29128100 | -3.61039100 | -0.76755200 |
| C | -1.77728600 | -2.51336100 | -1.46241800 |
| C | -1.64280300 | -1.25262600 | -0.85834900 |
| C | -2.02233400 | -1.10612400 | 0.50875300 |
| C | -2.51605600 | -2.22805100 | 1.19515300 |
| C | -2.66309500 | -3.46711300 | 0.56811900 |
| C | -1.63575400 | 1.55602400 | 0.33088500 |
| C | -1.25782100 | 1.40966600 | -1.03679700 |
| C | -1.04071000 | 2.56691500 | -1.80240300 |
| C | -1.20682400 | 3.84547600 | -1.26555700 |
| C | -1.57667800 | 3.98864200 | 0.07067300 |

Experimental Part – Calculations

| | | | |
|----|-------------|-------------|-------------|
| C | -1.77594500 | 2.85138400 | 0.85623000 |
| N | 1.90358200 | -0.27117600 | -0.02687400 |
| C | 3.18713700 | -0.36636600 | -0.44710500 |
| C | 3.78738800 | -0.18799900 | 1.75411100 |
| C | 2.49520100 | -0.08697900 | 2.23640000 |
| N | 1.58989100 | -0.14269300 | 1.21066700 |
| C | 4.14468800 | -0.31578400 | 0.54675500 |
| B | -1.90201600 | 0.28864800 | 1.21692200 |
| B | -1.10459700 | -0.02007400 | -1.67005200 |
| C | -2.13673700 | 0.42645600 | 2.77875500 |
| C | -0.51694300 | -0.20273200 | -3.12786200 |
| H | -2.39652200 | -4.57119600 | -1.26460600 |
| H | -1.48487500 | -2.64518300 | -2.50036200 |
| H | -2.80385800 | -2.13565100 | 2.23887500 |
| H | -3.06089100 | -4.31510700 | 1.11943200 |
| H | -0.74357900 | 2.47385200 | -2.84321200 |
| H | -1.04435200 | 4.72344900 | -1.88527000 |
| H | -1.70552200 | 4.97889300 | 0.49976800 |
| H | -2.05766000 | 2.98167300 | 1.89762100 |
| H | -1.61914800 | 1.28013300 | 3.22775900 |
| H | -3.20991800 | 0.58862800 | 2.96561200 |
| H | -1.86362500 | -0.47032900 | 3.34418800 |
| H | 0.20531500 | 0.56982000 | -3.40765500 |
| H | -0.04046400 | -1.17447900 | -3.28789800 |
| H | -1.34002700 | -0.13713300 | -3.85706900 |
| C | 1.99819200 | 0.06445800 | 3.63554100 |
| H | 0.90861300 | 0.10855600 | 3.64062600 |
| H | 2.32819300 | -0.77730900 | 4.25268100 |
| H | 2.39777800 | 0.97812100 | 4.08719800 |
| Cl | 3.45854600 | -0.53714600 | -2.14874000 |

5.10.3 [3,9]-Sigmatropic rearrangement

5.10.3.1 Optimization and frequency calculations

Starting Material **274** (MeO in *trans*-conformation):

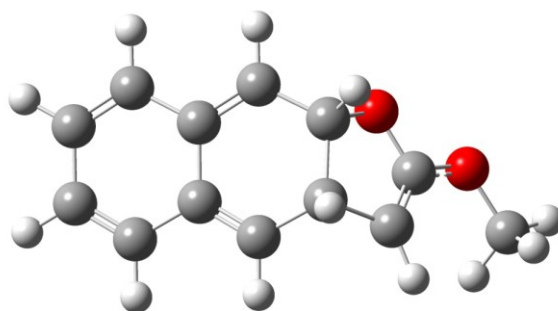

Cartesian coordinates of optimized structure:

| | | | |
|---|-------------|-------------|-------------|
| C | -3.77874300 | -1.06423000 | -0.65049300 |
| C | -2.62315300 | -1.58492000 | -0.17706400 |
| C | -1.52657000 | -0.73214800 | 0.25654100 |
| C | -1.68913000 | 0.73900500 | 0.11128200 |
| C | -2.96800800 | 1.22517700 | -0.38503100 |
| C | -3.95496100 | 0.37312500 | -0.74859200 |
| H | -0.28495300 | -2.31938700 | 0.90388100 |
| H | -4.59077100 | -1.71568700 | -0.95917700 |
| H | -2.48953700 | -2.66036500 | -0.09335100 |
| C | -0.39618700 | -1.24163100 | 0.80074500 |
| C | -0.67656900 | 1.58575000 | 0.42118100 |
| H | -3.10159500 | 2.30015300 | -0.47082400 |
| H | -4.89659300 | 0.75979500 | -1.12777200 |
| C | 0.73970100 | -0.39015100 | 1.30313200 |
| H | -0.80433500 | 2.65699400 | 0.29097000 |
| C | 0.66014500 | 1.10634100 | 0.88042100 |
| O | 1.64363600 | 1.26956700 | -0.21128700 |
| C | 2.46356200 | 0.19400300 | -0.13099500 |
| C | 2.08729100 | -0.77994300 | 0.71649100 |
| H | 2.58607100 | -1.72081400 | 0.88882700 |
| H | 0.74349200 | -0.45308500 | 2.40289200 |
| H | 1.03832100 | 1.73568200 | 1.69449600 |
| O | 3.52438800 | 0.32436000 | -0.93980800 |
| C | 4.41400400 | -0.78790000 | -0.96224700 |
| H | 3.89674800 | -1.69569800 | -1.29398400 |
| H | 5.20331500 | -0.53233400 | -1.66932400 |
| H | 4.84735100 | -0.96153800 | 0.02990100 |

Starting Material **274** (MeO in *cis*-conformation):

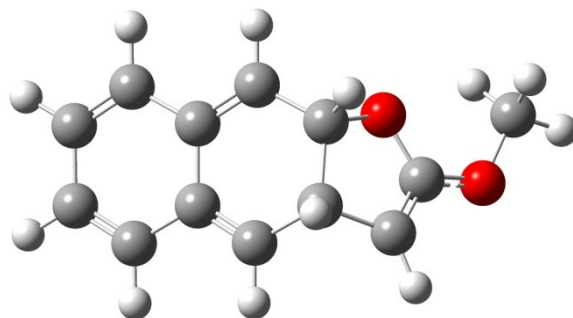

Cartesian coordinates of optimized structure:

| | | | |
|---|-------------|-------------|-------------|
| C | 3.84694900 | 0.40277900 | -0.93607700 |
| C | 2.79161200 | 1.21702300 | -0.70323600 |
| C | 1.60405600 | 0.74220200 | -0.00943500 |
| C | 1.55430100 | -0.68986200 | 0.38759300 |
| C | 2.73642900 | -1.49716400 | 0.12646500 |
| C | 3.81875400 | -0.98191300 | -0.50284600 |
| H | 0.62125400 | 2.61744300 | 0.00985200 |
| H | 4.73000200 | 0.77670900 | -1.44532800 |
| H | 2.81061000 | 2.25767600 | -1.01633400 |
| C | 0.57727300 | 1.56950100 | 0.29989100 |
| C | 0.44306600 | -1.21595800 | 0.96061800 |
| H | 2.71760600 | -2.53803900 | 0.43806000 |
| H | 4.68443000 | -1.60840600 | -0.69825800 |
| C | -0.64738100 | 1.12539800 | 1.05567100 |
| H | 0.41680200 | -2.26833600 | 1.23044700 |
| C | -0.79712600 | -0.41741400 | 1.18022100 |
| O | -1.81677500 | -0.79971500 | 0.17210600 |
| C | -2.47692900 | 0.35212200 | -0.13467600 |
| C | -1.94874400 | 1.48251200 | 0.35739300 |
| H | -2.32488200 | 2.48032600 | 0.19226800 |
| H | -0.59302500 | 1.56308200 | 2.06531700 |
| H | -1.25571000 | -0.66335500 | 2.14475500 |
| O | -3.56282700 | 0.23154700 | -0.91328800 |
| C | -4.14403900 | -1.07180600 | -1.03905300 |
| H | -4.48943300 | -1.44773200 | -0.07025600 |
| H | -4.99560500 | -0.94495600 | -1.70829100 |
| H | -3.43455900 | -1.78358900 | -1.46794700 |

Transition State **274** (MeO in *cis*-conformation) to **258b'**

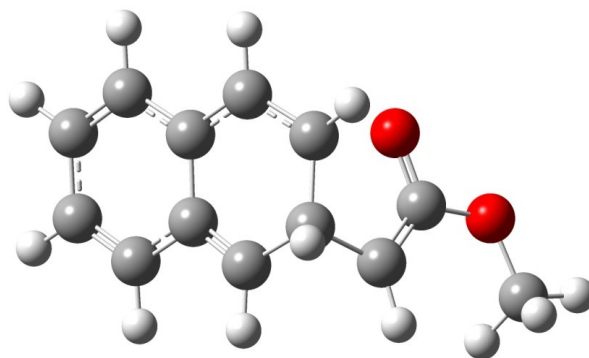

Cartesian coordinates of optimized structure:

| | | | |
|---|-------------|-------------|-------------|
| C | -3.46452200 | -1.43598300 | -0.49014500 |
| C | -2.28361700 | -1.67080400 | 0.15403000 |
| C | -1.37612000 | -0.59848000 | 0.45265700 |
| C | -1.70261500 | 0.75589500 | 0.01925900 |
| C | -2.96155000 | 0.94936400 | -0.63447400 |
| C | -3.80218400 | -0.10281100 | -0.88281500 |
| H | -0.07907800 | -1.76126600 | 1.69894500 |
| H | -4.15129700 | -2.24870700 | -0.70328400 |
| H | -2.01294800 | -2.67477200 | 0.47060600 |
| C | -0.25851600 | -0.79170800 | 1.24278800 |
| C | -0.81478200 | 1.81013900 | 0.24908700 |
| H | -3.22875900 | 1.95310300 | -0.95233100 |
| H | -4.74450900 | 0.07281200 | -1.39455600 |
| C | 0.75306700 | 0.26877400 | 1.49243000 |
| H | -1.07672500 | 2.80708200 | -0.09044700 |
| C | 0.47758800 | 1.55962600 | 0.73673000 |
| O | 1.60451100 | 1.19397300 | -0.79098500 |
| C | 2.28866400 | 0.20422400 | -0.35142200 |
| C | 1.93914900 | -0.41364100 | 0.83618800 |
| H | 2.45101300 | -1.24148900 | 1.30171500 |
| H | 0.90264900 | 0.48242800 | 2.56128600 |
| H | 1.08329900 | 2.40765400 | 1.03804100 |
| O | 3.36852100 | -0.11697700 | -1.10586100 |
| C | 4.18250400 | -1.19910400 | -0.66594000 |
| H | 3.60783600 | -2.13081200 | -0.60588000 |
| H | 4.97097000 | -1.30676800 | -1.41188500 |
| H | 4.63089200 | -0.98817800 | 0.31232100 |

Transition State **274** (MeO in *cis*-conformation) to **258b'**

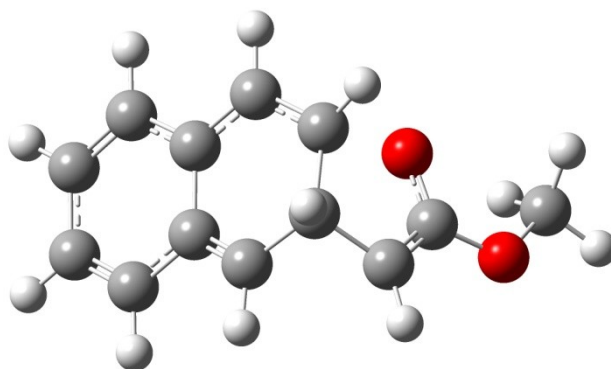

Cartesian coordinates of optimized structure:

| | | | |
|---|-------------|-------------|-------------|
| C | 3.56156000 | 0.53054100 | -1.21029800 |
| C | 2.48623900 | 1.27516300 | -0.82157900 |
| C | 1.47293400 | 0.72501600 | 0.03721400 |
| C | 1.57264100 | -0.67176000 | 0.45593900 |
| C | 2.73384500 | -1.40058100 | 0.03580900 |
| C | 3.68169200 | -0.82541100 | -0.76579100 |
| H | 0.46096800 | 2.57900700 | 0.38147500 |
| H | 4.32967600 | 0.95578200 | -1.84813500 |
| H | 2.38221300 | 2.30971300 | -1.13820800 |
| C | 0.47205600 | 1.50950000 | 0.57252600 |
| C | 0.57713000 | -1.25120100 | 1.23995300 |
| H | 2.83491800 | -2.43499200 | 0.35186800 |
| H | 4.54354600 | -1.40775700 | -1.08030700 |
| C | -0.64365800 | 0.96153600 | 1.39134500 |
| H | 0.67026000 | -2.29153500 | 1.53498000 |
| C | -0.62579100 | -0.55963800 | 1.49670000 |
| O | -1.81924800 | -0.94021800 | 0.08759600 |
| C | -2.33816600 | 0.22547100 | -0.11650800 |
| C | -1.80955600 | 1.33563200 | 0.49716600 |
| H | -2.17916000 | 2.34301900 | 0.37960300 |
| H | -0.69417200 | 1.40378800 | 2.39801700 |
| H | -1.28942300 | -0.96889300 | 2.25177600 |
| O | -3.44138200 | 0.33688700 | -0.89217300 |
| C | -3.93427600 | -0.87723700 | -1.46774000 |
| H | -4.28095900 | -1.56993200 | -0.69544100 |
| H | -4.76933300 | -0.58008300 | -2.10359200 |
| H | -3.16339700 | -1.37366900 | -2.06383600 |

Product **258b'** (*cis*-ester)

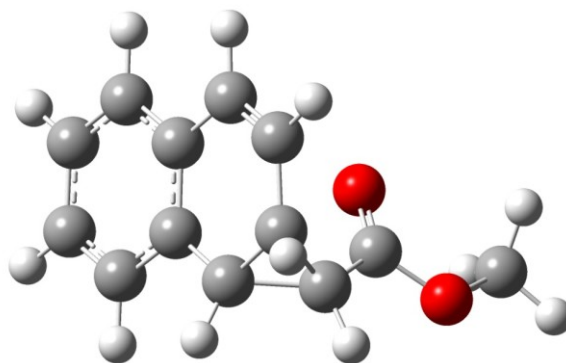

Cartesian coordinates of optimized structure:

| | | | |
|---|-------------|-------------|-------------|
| C | -2.95019700 | -1.56299100 | 0.67810800 |
| C | -1.89017900 | -0.94146100 | 1.33850200 |
| C | -1.15230600 | 0.07037900 | 0.71907500 |
| C | -1.51446500 | 0.49722600 | -0.58003000 |
| C | -2.58336700 | -0.13581000 | -1.23164800 |
| C | -3.29359600 | -1.16189500 | -0.61476600 |
| H | -0.17161800 | 0.78786300 | 2.52279100 |
| H | -3.50324300 | -2.35806000 | 1.16947000 |
| H | -1.62212200 | -1.25414700 | 2.34479800 |
| C | -0.03764500 | 0.73879400 | 1.44479100 |
| C | -0.81565400 | 1.61931100 | -1.19646500 |
| H | -2.85541000 | 0.18858100 | -2.23282600 |
| H | -4.11552200 | -1.64365800 | -1.13610500 |
| C | 0.64940300 | 1.90656600 | 0.77211200 |
| H | -1.14372700 | 1.93007400 | -2.18509200 |
| C | 0.17147500 | 2.28680100 | -0.57458500 |
| O | 1.31683900 | -0.63053700 | -1.03523000 |
| C | 1.91228500 | -0.29376400 | -0.03403300 |
| C | 1.43565100 | 0.60945800 | 1.04156400 |
| H | 2.13145900 | 0.68286600 | 1.86981500 |
| H | 0.97833200 | 2.73242800 | 1.39858900 |
| H | 0.63248800 | 3.15140100 | -1.04405900 |
| O | 3.17118000 | -0.72303200 | 0.25916500 |
| C | 3.74637700 | -1.61308400 | -0.70806400 |
| H | 3.82234600 | -1.12819600 | -1.68476700 |
| H | 4.73714100 | -1.86202900 | -0.32762300 |
| H | 3.13903600 | -2.51574400 | -0.81383100 |

Product **258b'** (*trans*-ester)

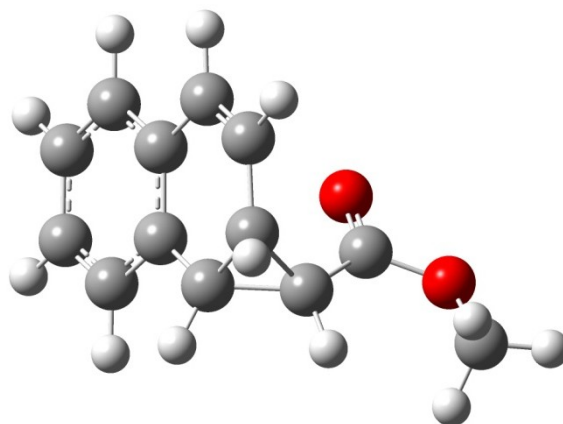

Cartesian coordinates of optimized structure:

| | | | |
|---|-------------|-------------|-------------|
| C | -3.09818200 | -1.57907200 | 0.26731900 |
| C | -1.89004100 | -1.37541400 | 0.93498200 |
| C | -1.11064100 | -0.24564900 | 0.67827200 |
| C | -1.57491000 | 0.72381600 | -0.24035800 |
| C | -2.79151000 | 0.50769000 | -0.90309800 |
| C | -3.54724800 | -0.63598300 | -0.65917000 |
| H | 0.15897600 | -0.43634500 | 2.42980300 |
| H | -3.68379500 | -2.47144300 | 0.46748500 |
| H | -1.54022000 | -2.11059500 | 1.65568400 |
| C | 0.15961600 | -0.02391500 | 1.42342300 |
| C | -0.81323900 | 1.95014900 | -0.44520000 |
| H | -3.14229600 | 1.24999800 | -1.61546400 |
| H | -4.48474700 | -0.78994200 | -1.18520200 |
| C | 0.89216100 | 1.27964300 | 1.21016400 |
| H | -1.21113800 | 2.67308100 | -1.15277200 |
| C | 0.31621000 | 2.22477300 | 0.23094700 |
| O | 0.94976300 | -0.35022900 | -1.51054200 |
| C | 1.78685900 | -0.40716400 | -0.64122600 |
| C | 1.55376300 | -0.05547800 | 0.78592600 |
| H | 2.31928000 | -0.37234200 | 1.48320900 |
| H | 1.38313800 | 1.73740000 | 2.06601800 |
| H | 0.82572600 | 3.17392000 | 0.08973300 |
| O | 3.04438200 | -0.82053700 | -0.99586400 |
| C | 4.13506100 | -0.82644700 | -0.07689100 |
| H | 4.00975800 | -1.58497900 | 0.70475900 |
| H | 5.01644400 | -1.07856600 | -0.66886400 |
| H | 4.28831800 | 0.15426100 | 0.38632900 |

5.10.3.2 Thermochemistry

(*trans*-ester)³⁴

| [Hartree] | starting material | transition state | product |
|---------------------------------|-------------------|------------------|------------|
| $\epsilon_0 + G_{\text{corr}}$ | -652.80711 | -652.78815 | -652.86944 |
| | [Hartree] | [kcal/mol] | |
| $\Delta^\ddagger G^0_{(T=298)}$ | 0.01896 | 11.9 | |
| $\Delta_r G^0_{(T=298)}$ | -0.06234 | -39.1 | |

(*cis*-ester)

| [Hartree] | starting material | transition state | product |
|---------------------------------|-------------------|------------------|------------|
| $\epsilon_0 + G_{\text{corr}}$ | -652.807321 | -652.792526 | -652.85544 |
| | [Hartree] | [kcal/mol] | |
| $\Delta^\ddagger G^0_{(T=298)}$ | 0.01480 | 9.3 | |
| $\Delta_r G^0_{(T=298)}$ | -0.04811 | -30.2 | |

5.10.3.3 IRC-calculations

IRC Calculation Output (*trans*-ester)

Energies reported relative to the TS energy of -652.965701

 Summary of reaction path following

| | Energy | Rx Coord |
|----|----------|-----------|
| 1 | -0.06843 | -15.89939 |
| 2 | -0.06829 | -15.57316 |
| 3 | -0.06812 | -15.24500 |
| 4 | -0.06794 | -14.91269 |
| 5 | -0.06773 | -14.58052 |
| 6 | -0.06751 | -14.25219 |
| 7 | -0.06727 | -13.92436 |
| 8 | -0.06702 | -13.59500 |
| 9 | -0.06674 | -13.26485 |
| 10 | -0.06645 | -12.93419 |
| 11 | -0.06613 | -12.60482 |
| 12 | -0.06580 | -12.27327 |
| 13 | -0.06546 | -11.94026 |
| 14 | -0.06509 | -11.60891 |

| | | |
|----|----------|-----------|
| 15 | -0.06471 | -11.27781 |
| 16 | -0.06431 | -10.94634 |
| 17 | -0.06388 | -10.61405 |
| 18 | -0.06344 | -10.28317 |
| 19 | -0.06297 | -9.95599 |
| 20 | -0.06246 | -9.62421 |
| 21 | -0.06190 | -9.29264 |
| 22 | -0.06130 | -8.96078 |
| 23 | -0.06063 | -8.63044 |
| 24 | -0.05988 | -8.29894 |
| 25 | -0.05905 | -7.96853 |
| 26 | -0.05812 | -7.63656 |
| 27 | -0.05709 | -7.30599 |
| 28 | -0.05595 | -6.97574 |
| 29 | -0.05468 | -6.64614 |
| 30 | -0.05325 | -6.31487 |
| 31 | -0.05164 | -5.98387 |
| 32 | -0.04980 | -5.65278 |
| 33 | -0.04765 | -5.32203 |
| 34 | -0.04511 | -4.99194 |
| 35 | -0.04213 | -4.65994 |
| 36 | -0.03875 | -4.32735 |
| 37 | -0.03511 | -3.99470 |
| 38 | -0.03132 | -3.66162 |
| 39 | -0.02752 | -3.32850 |
| 40 | -0.02377 | -2.99550 |
| 41 | -0.02012 | -2.66259 |
| 42 | -0.01658 | -2.32975 |
| 43 | -0.01318 | -1.99700 |
| 44 | -0.00992 | -1.66430 |
| 45 | -0.00688 | -1.33161 |
| 46 | -0.00417 | -0.99887 |
| 47 | -0.00197 | -0.66603 |
| 48 | -0.00050 | -0.33312 |
| 49 | 0.00000 | 0.00000 |
| 50 | -0.00051 | 0.33296 |
| 51 | -0.00198 | 0.66593 |
| 52 | -0.00419 | 0.99885 |
| 53 | -0.00686 | 1.33172 |
| 54 | -0.00967 | 1.66442 |
| 55 | -0.01228 | 1.99642 |
| 56 | -0.01441 | 2.32556 |
| 57 | -0.01596 | 2.64648 |
| 58 | -0.01713 | 2.97095 |
| 59 | -0.01802 | 3.29791 |

| | | |
|----|----------|---------|
| 60 | -0.01869 | 3.62428 |
| 61 | -0.01919 | 3.94955 |
| 62 | -0.01954 | 4.26260 |
| 63 | -0.01980 | 4.56351 |
| 64 | -0.02003 | 4.88149 |
| 65 | -0.02022 | 5.20482 |

IRC calculation output (*cis*-ester)

Energies reported relative to the TS energy of -652.969501

Summary of reaction path following

| | Energy | Rx Coord |
|----|----------|-----------|
| 1 | -0.07807 | -14.44562 |
| 2 | -0.07783 | -14.10792 |
| 3 | -0.07756 | -13.77178 |
| 4 | -0.07728 | -13.43927 |
| 5 | -0.07698 | -13.10729 |
| 6 | -0.07667 | -12.78140 |
| 7 | -0.07634 | -12.44654 |
| 8 | -0.07598 | -12.11346 |
| 9 | -0.07561 | -11.78139 |
| 10 | -0.07520 | -11.44516 |
| 11 | -0.07478 | -11.11074 |
| 12 | -0.07432 | -10.77588 |
| 13 | -0.07382 | -10.44221 |
| 14 | -0.07327 | -10.10889 |
| 15 | -0.07265 | -9.77493 |
| 16 | -0.07195 | -9.43810 |
| 17 | -0.07116 | -9.10133 |
| 18 | -0.07026 | -8.76682 |
| 19 | -0.06923 | -8.43120 |
| 20 | -0.06807 | -8.09660 |
| 21 | -0.06676 | -7.75997 |
| 22 | -0.06529 | -7.42316 |
| 23 | -0.06365 | -7.08597 |
| 24 | -0.06183 | -6.74898 |
| 25 | -0.05982 | -6.41229 |
| 26 | -0.05758 | -6.07553 |
| 27 | -0.05508 | -5.74016 |
| 28 | -0.05223 | -5.40380 |
| 29 | -0.04900 | -5.06678 |

| | | |
|----|----------|----------|
| 30 | -0.04540 | -4.72921 |
| 31 | -0.04153 | -4.39147 |
| 32 | -0.03752 | -4.05343 |
| 33 | -0.03347 | -3.71536 |
| 34 | -0.02948 | -3.37740 |
| 35 | -0.02557 | -3.03952 |
| 36 | -0.02176 | -2.70174 |
| 37 | -0.01805 | -2.36406 |
| 38 | -0.01443 | -2.02647 |
| 39 | -0.01093 | -1.68894 |
| 40 | -0.00761 | -1.35138 |
| 41 | -0.00461 | -1.01373 |
| 42 | -0.00217 | -0.67594 |
| 43 | -0.00056 | -0.33809 |
| 44 | 0.00000 | 0.00000 |
| 45 | -0.00053 | 0.33805 |
| 46 | -0.00200 | 0.67588 |
| 47 | -0.00410 | 1.01363 |
| 48 | -0.00648 | 1.35121 |
| 49 | -0.00873 | 1.68785 |
| 50 | -0.01051 | 2.01816 |
| 51 | -0.01178 | 2.34090 |
| 52 | -0.01276 | 2.67071 |
| 53 | -0.01355 | 3.00687 |
| 54 | -0.01416 | 3.34318 |
| 55 | -0.01463 | 3.67834 |
| 56 | -0.01498 | 4.00393 |
| 57 | -0.01522 | 4.30088 |
| 58 | -0.01541 | 4.61689 |
| 59 | -0.01557 | 4.93856 |

5.10.3.4 Mulliken charge distribution

Starting material **274**:

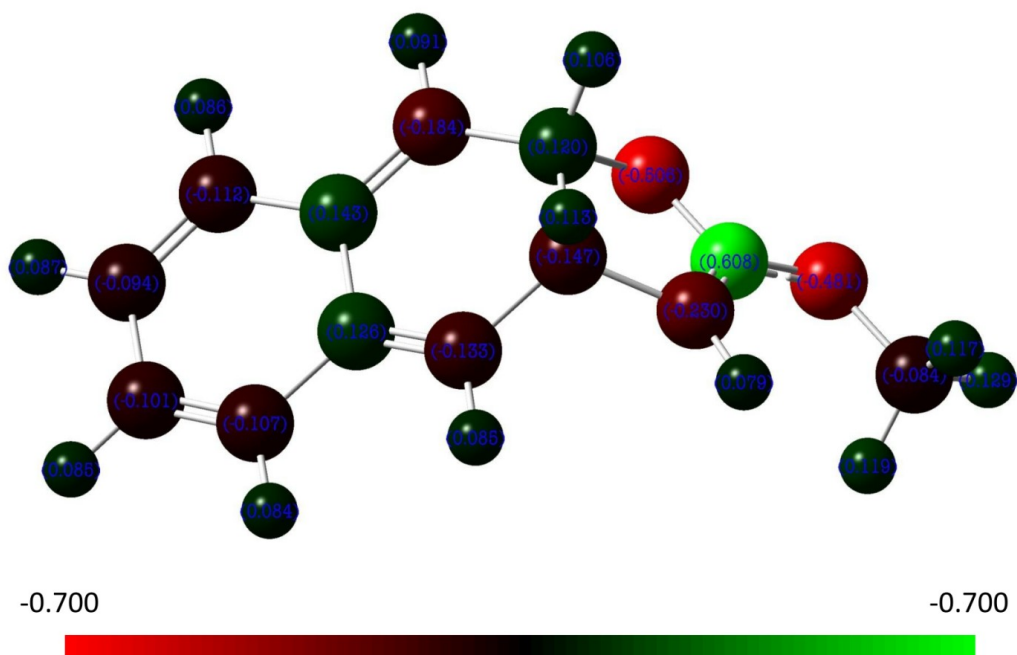

Transition state **274** to **258b**?

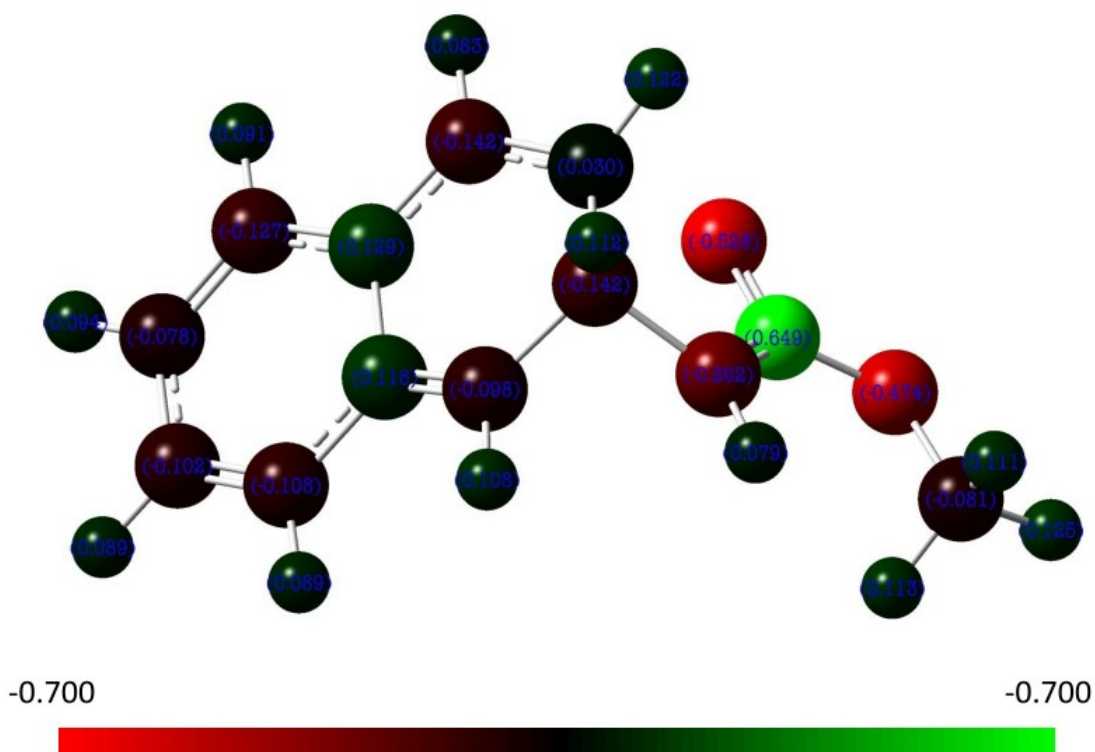

Product **258b'**:

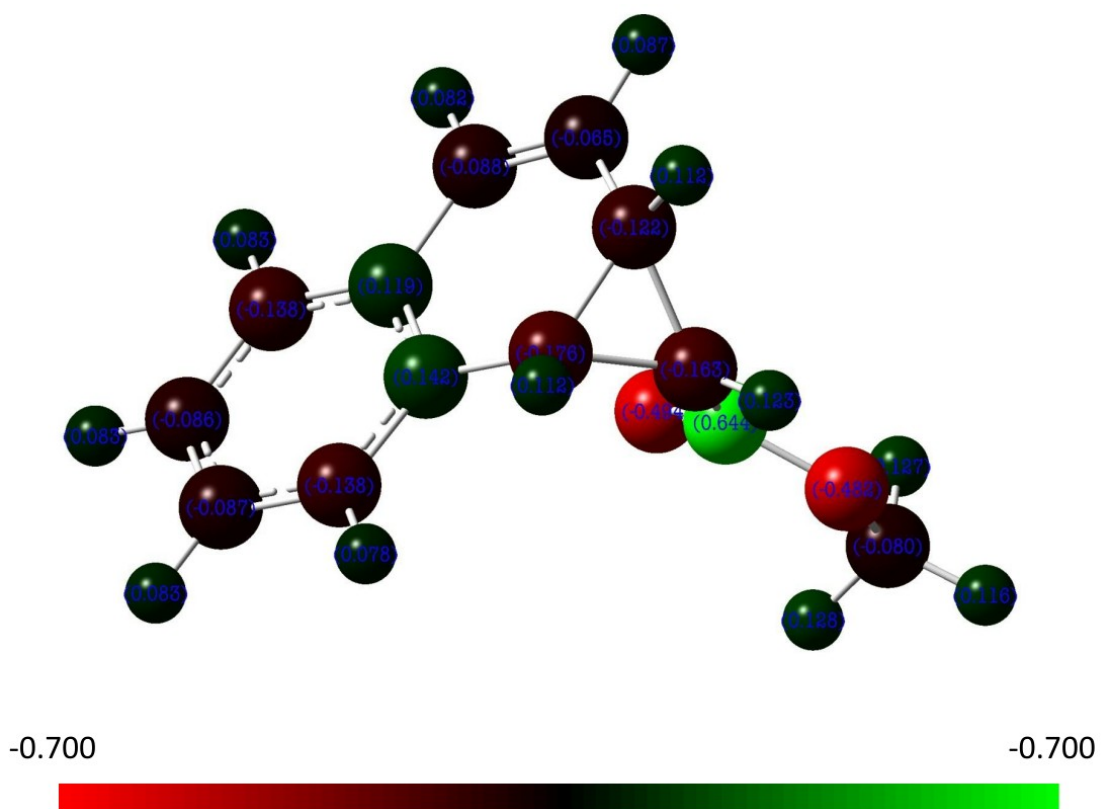

5.10.4 [1,9]-Sigmatropic rearrangement

5.10.4.1 Thermochemistry

| [Hartree] | starting material | transition state | product |
|---------------------------------|-------------------|------------------|------------|
| $\epsilon_0 + G_{\text{corr}}$ | -578.803505 | -578.74622 | -578.84107 |
| | [Hartree] | [kcal/mol] | |
| $\Delta^\ddagger G^0_{(T=298)}$ | 0.05728 | 35.9 | |
| $\Delta_r G^\circ_{(T=298)}$ | -0.03756 | -23.6 | |

| [Hartree] | starting material | transition state | product |
|---------------------------------|-------------------|------------------|------------|
| $\epsilon_0 + G_{\text{corr}}$ | -1214.763699 | -1214.710 | -1214.8034 |
| | [Hartree] | [kcal/mol] | |
| $\Delta^\ddagger G^0_{(T=298)}$ | 0.05411 | 34.0 | |
| $\Delta_r G^\circ_{(T=298)}$ | -0.03969 | -24.9 | |

5.10.4.2 Optimization and frequency calculations

Transition State to product **296a**

Cartesian coordinates of optimized structure:

```

C      -3.23313200  -1.13861800  0.13835100
C      -1.92444800  -1.50907600  0.31407800
C      -0.87243400  -0.55021300  0.19715900
C      -1.18746900   0.81136300 -0.18025700
C      -2.55652700   1.15474000 -0.35113500
C      -3.54442000   0.21060200 -0.19044900
H       0.69150800  -1.92343600  0.66356100
H      -4.03259500  -1.86407500  0.24838600
H      -1.66749400  -2.53339000  0.57140700
C       0.46046800  -0.88797300  0.41174700
C      -0.11956900   1.68651800 -0.46413100
H      -2.81069800   2.17391800 -0.62835100
H      -4.58424900   0.49412200 -0.32856300
C       1.52413300   0.13794900  0.65892900
    
```

| | | | |
|---|-------------|-------------|-------------|
| H | -0.32371600 | 2.63491300 | -0.95113700 |
| C | 1.18714200 | 1.25674700 | -0.28719900 |
| O | 1.47759300 | -0.34994600 | -1.65222800 |
| C | 2.71078700 | -0.82300600 | -1.23638700 |
| C | 2.89644400 | -0.43270300 | 0.26324200 |
| H | 3.16636000 | -1.28705300 | 0.89535400 |
| H | 1.99637300 | 1.93356500 | -0.55317800 |
| C | 1.52213100 | 0.59070800 | 2.14590600 |
| H | 1.73515500 | -0.25469200 | 2.80785700 |
| H | 2.29339800 | 1.34939600 | 2.31179800 |
| H | 0.55438700 | 1.01626600 | 2.42310600 |
| H | 2.77804600 | -1.92326300 | -1.33797300 |
| H | 3.53503000 | -0.39010700 | -1.83426500 |
| H | 3.66911700 | 0.33117300 | 0.41070100 |

Transition State to product **298a**

Cartesian coordinates of optimized structure:

| | | | |
|---|-------------|-------------|-------------|
| C | -3.74485100 | -0.13966600 | -0.19167400 |
| C | -2.70583800 | -1.02106100 | -0.13081500 |
| C | -1.35221800 | -0.60513300 | 0.05868600 |
| C | -1.06499900 | 0.81025200 | 0.10771300 |
| C | -2.17782200 | 1.69519700 | 0.04276300 |
| C | -3.46356300 | 1.25599200 | -0.10040100 |
| H | -0.50478000 | -2.55120800 | 0.06978300 |
| H | -4.76032800 | -0.49836100 | -0.30594200 |
| C | -0.29304200 | -1.48786900 | 0.15307700 |
| C | 0.26232300 | 1.23513100 | 0.11658700 |
| H | -4.26712700 | 1.98225600 | -0.15408600 |
| C | 1.05306100 | -1.10185100 | 0.70243200 |
| H | 0.46271800 | 2.29102300 | 0.00700700 |
| C | 1.30785600 | 0.29025900 | 0.14178500 |
| O | 1.06525600 | -0.80737500 | -1.63169400 |
| C | 1.95533000 | -1.85552700 | -1.42709600 |
| C | 2.08780800 | -2.07995000 | 0.11333300 |
| H | 1.84548500 | -3.10577800 | 0.41389000 |
| C | 1.04139600 | -1.14379000 | 2.25141700 |
| H | 0.80726300 | -2.15275900 | 2.60478800 |
| H | 2.02313400 | -0.86399700 | 2.64435200 |
| H | 0.29678700 | -0.45291400 | 2.65543100 |
| H | 1.58718500 | -2.78282400 | -1.90224400 |
| H | 2.94762100 | -1.63745500 | -1.85632700 |
| H | 3.09046400 | -1.86710600 | 0.49727400 |

Experimental Part – Calculations

| | | | |
|---|-------------|-------------|-------------|
| F | -1.92120800 | 3.02290000 | 0.10441700 |
| F | -2.93930700 | -2.34781500 | -0.20659100 |
| S | 2.98984400 | 0.82659000 | 0.18926600 |
| C | 2.92947900 | 2.52094700 | -0.48197400 |
| H | 3.97158100 | 2.80842300 | -0.63467600 |
| H | 2.41061600 | 2.52758600 | -1.44190700 |
| H | 2.46493700 | 3.22332000 | 0.21250900 |

5.11 References

- (1) Schulz, H.; Pritzkow, H.; Siebert, W. *Chem. Ber.* **1991**, *124*, 2203–2207.
- (2) Bettinger, H. F.; Filthaus, M. *J. Org. Chem.* **2007**, *72*, 9750–9752.
- (3) Pale, P.; Chuche, J. *Eur. J. Org. Chem.* **2000**, *2000*, 1019–1025.
- (4) Ducoux, J. P.; Le Menez, P.; Kunesch, N.; Wenkert, E. *J. Org. Chem.* **1993**, *58*, 1290–1292.
- (5) Taskinen, E.; Pentikäinen, M.-L. *Tetrahedron* **1978**, *34*, 2365–2370.
- (6) Bochler, M. A.; Konopelski, J. P. *Tetrahedron* **1991**, *47*, 4519–4538.
- (7) Kim, D. W.; Hong, D. J.; Seo, J. W.; Kim, H. S.; Kim, H. K.; Song, C. E.; Chi, D. Y. *J. Org. Chem.* **2004**, *69*, 3186–3189.
- (8) Puri, N.; Zamaratski, E.; Sund, C.; Chattopadhyaya, J. *Tetrahedron* **1997**, *53*, 10409–10432.
- (9) Hsieh, J.-C.; Cheng, C.-H. *Chem. Commun.* **2008**, 2992–2994.
- (10) Hsieh, J.-C.; Cheng, C.-H. *Chem. Commun.* **2005**, 2459–2461.
- (11) Tius, M. A.; Gomez-Galeno, J. *Tetrahedron Lett.* **1986**, *27*, 2571–2574.
- (12) Rao, C. S.; Balu, M. P.; Ila, H.; Junjappa, H. *Tetrahedron* **1991**, *47*, 3499–3510.
- (13) Jagdale, A. R.; Park, J. H.; Youn, S. W. *J. Org. Chem.* **2011**, *76*, 7204–7215.
- (14) Guan, B.-T.; Xiang, S.-K.; Wang, B.-Q.; Sun, Z.-P.; Wang, Y.; Zhao, K.-Q.; Shi, Z.-J. *J. Am. Chem. Soc.* **2008**, *130*, 3268–3269.
- (15) Baroudi, A.; Mauldin, J.; Alabugin, I. V. *J. Am. Chem. Soc.* **2010**, *132*, 967–979.
- (16) Cho, C.-H.; Sun, M.; Seo, Y.-S.; Kim, C.-B.; Park, K. *J. Org. Chem.* **2005**, *70*, 1482–1485.
- (17) Johnson, E. A. *J. Chem. Soc.* **1962**, 994–997.
- (18) Anderson, R. K.; Carter, S. D.; Cheeseman, G. W. H. *Tetrahedron* **1979**, *35*, 2463–2470.
- (19) Decroix, B.; Morel, J.; Pastour, P.; Paulmier, C. *Bull. Soc. Chim. Fr.* **1972**, 3453–3462.
- (20) Robba, M.; Zaluski, M.-C. *Bull. Soc. Chim. Fr.* **1968**, 4959–4967.
- (21) Robba, M.; Zaluski, M.-C.; Roques, B.; Bonhomme, M. *Bull. Soc. Chim. Fr.* **1969**, 4004–4013.
- (22) Dore, G.; Bonhomme, M.; Robba, M. *Tetrahedron* **1972**, *28*, 2553–2573.
- (23) Dupas, G.; Duflos, J.; Quéguiner, G. *J. Heterocycl. Chem.* **1980**, *17*, 93–96.
- (24) Queguine, G.; Pastour, P. *C.R. Hebd. Seances Acad. Sci. Ser. C* **1966**, *262*, 1335–1338.
- (25) Hay, M. B.; Wolfe, J. P. *Tetrahedron Lett.* **2006**, *47*, 2793–2796.

- (26) Sonawane, H. R.; Bellur, N. S.; Kulkarni, D. G.; Ayyangar, N. R. *Tetrahedron* **1994**, *50*, 1243–1260.
- (27) Kempainen, E. K.; Sahoo, G.; Valkonen, A.; Pihko, P. M. *Org. Lett.* **2012**, *14*, 1086–1089.
- (28) Evans, D. A.; Kværnø, L.; Dunn, T. B.; Beauchemin, A.; Raymer, B.; Mulder, J. A.; Olhava, E. J.; Juhl, M.; Kagechika, K.; Favor, D. A. *J. Am. Chem. Soc.* **2008**, *130*, 16295–16309.
- (29) Simmons, B.; Walji, A. M.; MacMillan, D. W. C. *Angew. Chem. Int. Ed.* **2009**, *48*, 4349–4353.
- (30) Müller, P.; Toujas, J.-L.; Bernardinelli, G. *Helv. Chim. Acta* **2000**, *83*, 1525–1534.
- (31) Barrett, D. G.; Gellman, S. H. *Tetrahedron Lett.* **1994**, *35*, 2299–2300.
- (32) Lorbach, A.; Bolte, M.; Li, H.; Lerner, H.-W.; Holthausen, M. C.; Jäkle, F.; Wagner, M. *Angew. Chem. Int. Ed.* **2009**, *48*, 4584–4588.
- (33) Lorbach, A.; Bolte, M.; Lerner, H.-W.; Wagner, M. *Chem. Commun.* **2010**, *46*, 3592.
- (34) Gaussian 09, Revision A.02, Frisch, M. J.; Trucks, G. W.; Schlegel, H. B.; Scuseria, G. E.; Robb, M. A.; Cheeseman, J. R.; Scalmani, G.; Barone, V.; Mennucci, B.; Petersson, G. A.; Nakatsuji, H.; Caricato, M.; Li, X.; Hratchian, H. P.; Izmaylov, A. F.; Bloino, J.; Zheng, G.; Sonnenberg, J. L.; Hada, M.; Ehara, M.; Toyota, K.; Fukuda, R.; Hasegawa, J.; Ishida, M.; Nakajima, T.; Honda, Y.; Kitao, O.; Nakai, H.; Vreven, T.; Montgomery, Jr., J. A.; Peralta, J. E.; Ogliaro, F.; Bearpark, M.; Heyd, J. J.; Brothers, E.; Kudin, K. N.; Staroverov, V. N.; Kobayashi, R.; Normand, J.; Raghavachari, K.; Rendell, A.; Burant, J. C.; Iyengar, S. S.; Tomasi, J.; Cossi, M.; Rega, N.; Millam, J. M.; Klene, M.; Knox, J. E.; Cross, J. B.; Bakken, V.; Adamo, C.; Jaramillo, J.; Gomperts, R.; Stratmann, R. E.; Yazyev, O.; Austin, A. J.; Cammi, R.; Pomelli, C.; Ochterski, J. W.; Martin, R. L.; Morokuma, K.; Zakrzewski, V. G.; Voth, G. A.; Salvador, P.; Dannenberg, J. J.; Dapprich, S.; Daniels, A. D.; Farkas, Ö.; Foresman, J. B.; Ortiz, J. V.; Cioslowski, J.; Fox, D. J. Gaussian, Inc., Wallingford CT, 2009.
- (35) Ochterski, J. W. Thermochemistry in Gaussian; Gaussian, Inc.: Wallingford, CT, 2000. http://www.gaussian.com/g_whitepap/thermo/thermo.pdf (accessed Oct 10, 2012).

6 Appendix

6.1 Abbreviations

| | | | |
|-------------------|---|---------------|--------------------------------------|
| 6-31g | Gaussian basis set | | |
| Å | Angstrom | Ac | acetyl |
| Alox | aluminium oxide | | |
| b3lyp | Becke, three-parameter, Lee-Yang-Parr (exchange-correlation functional) | | |
| BD | bidentate | BMEA | bis(2-methoxyethyl)amine |
| BuLi | butyllithium | DA | Diels-Alder |
| DMG | directed metalation group | DCE | 1,2-dichloroethane |
| DCM | dichloromethane | DFT | density functional theory |
| DIBAL-H | diisobutylaluminum hydride | DIEA | diisopropylethylamine |
| DMF | N,N-dimethylformamide | EA | elemental analysis |
| EI | electron impact | ESI | electron spray ionisation |
| Et ₃ N | triethylamine | EtOAc | ethyl acetate |
| EtOH | ethanol | eq. | equivalents |
| ERG | electron releasing group | eV | electron volts |
| EWG | electron withdrawing group | FAB | fast electron bombardment |
| FVP | flash vacuum pyrolysis | FMO | frontier molecular orbital |
| FT | fourier transformation | G | Gibbs free energy |
| GC | gas chromatography | <i>h</i> | Planck constant |
| Hex | hexane | <i>hν</i> | Planck relation (energy of a photon) |
| HOMO | highest occupied molecular orbital | | |
| HPLC | high performance liquid chromatography | | |
| HSQC | Heteronuclear Single Quantum Correlation | | |
| i.a. | inter alia | i.e. | id est |
| IEDDA | inverse electron demand Diels-Alder | | |
| IR | infrared | IRC | intrinsic reaction coordinate |
| KS | Klopman-Salem | LA | Lewis acid |
| LDA | lithium diisopropylamine | LG | leaving group |
| LUMO | lowest unoccupied molecular orbital | | |
| <i>m</i> | <i>meta</i> | <i>m</i> CPBA | <i>m</i> -chloroperbenzoic acid |
| MD | monodentate | MP | melting point |

Appendix

| | | | |
|----------|-------------------------------------|----------|-------------------------------|
| MPV | Meerwein-Ponndorf-Verley | m/z | mass to charge ratio |
| NMR | nuclear magnetic resonance | <i>o</i> | <i>ortho</i> |
| <i>p</i> | <i>para</i> | PG | protecting group |
| Ph | phenyl | ppm | parts per million |
| PTAD | 4-phenyl-1,2,4-triazoline-3,5-dione | | |
| <i>s</i> | secondary | SOI | secondary orbital interaction |
| <i>t</i> | tertiary | TBAB | tetrabutylammonium bromide |
| TBME | tertbutylmethylether | TEA | triethylamine |
| TES | triethyleneglycol | THF | tetrahydrofurane |
| TOCSY | Total Correlation Spectroscopy | TS | transition state |
| TsOH | toluenesulfonic acid | RNA | ribonucleic acid |
| rt | room temperature | TBAF | tetrabutylammonium fluoride |
| TBME | <i>tert</i> -butylmethyl ether | TIPS | triisopropylsilyl |
| TMDA | trimethylethylenediamine | TMEDA | tetramethylethylenediamine |
| TMS | trimethylsilyl | TLC | thin layer chromatography |
| UV | ultraviolet | ν | frequency |

6.2 Curriculum vitae: Simon N. Kessler

Personal Information

Contact Rosengasse 14, 8775 Hätzingen, Switzerland
Phone: 079 421 71 39
E-mail: Simon.Kessler@unibas.ch

Date of birth 27.07.1983

Hometown Schiers-Schuders (GR)

Nationality Swiss

Studies

09/2008 – 12/2012 **Chemistry, Ph. D., University of Basel**
Doctoral Thesis supervised by PD Dr. Hermann Wegner and advised by Prof. Dr. Andreas Pfaltz: „*Development of a Bidentate Lewis Acid Catalyzed Inverse Electron Demand Diels-Alder Reaction of 1,2-Diazines for the Synthesis of Substituted Arenes*“

04/2007 – 08/2008 **Chemistry, M. Sc., University of Basel**
Master Thesis in the Group of PD Dr. Hermann Wegner: „*Inverse Electron Demand Diels-Alder Reaction of 1,2-Diazines for the Synthesis of Substituted Arenes*“

10/2003 – 01/2007 **Chemistry, Diploma, University of Applied Sciences Basel**
Diploma Thesis at NIBR, Novartis Pharma AG Basel: „*New NIRF Substrates for NTR Based on Oxazine Dyes*“

Education

2000 – 2003 **Chemical Laboratory Technician with Vocational Diploma**
Novartis Pharma AG in Basel and Muttenz.

1990 – 1999 **Primary- and Secondary School**
Hätzingen and Linthal, Glarus.

Other Professional Experience

09/2004 – 10/2004 Internship in Organic Synthesis, Novartis Pharma AG Basel.

List of Publications

“*Domino Inverse Electron-Demand Diels–Alder/Cyclopropanation Reaction of Diazines Catalyzed by a Bidentate Lewis Acid*” Kessler S. N.; Neuburger, M.; Wegner, H. A. *J. Am. Chem. Soc.* **2012**, *134*, 17885-17888.

“*Bidentate Lewis Acid Catalyzed Inverse-Electron-Demand Diels-Alder Reaction for the Selective Functionalization of Aldehydes*” Schweighauser L., Bodoky I., Kessler S. N., Häussinger D., Wegner H. A. *Synthesis* **2012**, *44*, 2195-2199.

„*One-Pot Procedure for the Synthesis of Substituted Pyridazin-Annulated Aromatics*” Kessler S. N., Wegner H. A., *Org. Lett.* **2012**, *14*, 3268-3271.

„*Bidentate Lewis Acids for the Activation of 1,2-Diazines in Organic Synthesis*” Wegner H. A., Kessler S. N. *Synlett* **2012**, 699-705.

„*Bidentate Lewis Acids for the Activation of 1,2-Diazines – a New Mode of Catalysis*“ Kessler S. N.; Neuburger, M.; Wegner, H. A. *Eur. J. Org. Chem.* **2011**, 3238-3245.

„Lewis Acid Catalyzed Inverse Electron-Demand Diels-Alder Reaction of 1,2-Diazines“ Kessler, S. N., Wegner, H. A. *Org. Lett.* **2010**, 12, 4062-4065.

„A Convenient Iron-Catalyzed Method for the Preparation of 1,2-Bis(trimethylsilyl)benzenes“ Bader S. L., Kessler S. N., Wegner H. A. *Synthesis* **2010**, 2759–2762.

Poster Presentations

09/2012 „Bidentate Lewis Acid Catalysis: A New Entry to Highly Substituted Naphthalenes“, Kessler, S. N., Wegner, Fall Meeting Swiss Chemical Society (SCS), Zürich/CH.

07/2012 „Bidentate Lewis Acid Catalysis: A New Entry to Highly Substituted Naphthalenes“, Kessler, S. N., Wegner, H. A., 13th Belgian Organic Synthesis Symposium (BOSS XIII), Leuven/BE.

09/2011 „Bidentate Lewis Acids as Efficient Catalysts for the Inverse Electron Demand Diels-Alder Reaction“, Kessler, S. N., Wegner, H. A., Hochschule friff Industriev VII (HTI-VII), Schlangenbad/D.

07/2011 „Bidentate Lewis Acids as Efficient Catalysts for the Inverse Electron Demand Diels-Alder Reaction“, Kessler, S. N., Wegner, H. A., 14th International Symposium on Novel Aromatic Compounds (ISNA-14), Eugene, Oregon/USA.

09/2010 „Bidentate Lewis Acid Catalyzed Inverse Electron Demand Diels-Alder Reaction – From Calculations to a New Principle in Catalysis“, Kessler, S. N., Wegner, H. A., Meuwly, M., Fall Meeting Swiss Chemical Society (SCS), Zürich/CH.

08/2010 „Bidentate Lewis Acids as Efficient Catalysts for the Inverse Electron Demand Diels-Alder Reaction“, Kessler, S. N., Wegner, H. A., 4th Congress of the European Association for Chemical and Molecular Science (EuCheMS), Nürnberg/D.

09/2009 „Development of a Catalyst for the Inverse Electron Demand Diels-Alder Reaction of 1,2-Diazines“, Kessler, S. N., Wegner, H. A., 29. REGIO-Symposium, Rheinfelden/D.

07/2009 „Development of a Catalyst for the Inverse Electron Demand Diels-Alder Reaction of 1,2-Diazines“, Kessler, S. N., Wegner, H. A., 13th International Symposium on Novel Aromatic Compounds (ISNA-13), Luxembourg/L.

Oral Presentations

09/2011 "Bidentate Lewis Acids as Efficient Catalysts for the Inverse Electron Demand Diels-Alder Reaction" Kessler, S. N., Wegner, H. A., Fall Meeting Swiss Chemical Society (SCS), Lausanne/CH.

Awards

2011 SCNAT/SCS Chemistry Travel Award