

Acetylcholine Receptor–aggregating Activity of Agrin Isoforms and Mapping of the Active Site

Matthias Gesemann, Alain J. Denzer, and Markus A. Ruegg

Department of Pharmacology, Biozentrum, University of Basel, CH-4056 Basel, Switzerland

Abstract. Agrin is a basal lamina protein that induces aggregation of acetylcholine receptors (AChRs) and other molecules at the developing neuromuscular junction. Alternative splicing of chick agrin mRNA at two sites, A and B, gives rise to eight possible isoforms of which five are expressed *in vivo*. Motor neurons express high levels of isoforms with inserts at sites A and B, muscle cells synthesize isoforms that lack amino acids at the B-site. To obtain further insights into the mechanism of agrin-induced AChR aggregation, we have determined the EC_{50} (effective concentration to induce half-maximal AChR clustering) of each agrin isoform and of truncation mutants. On chick myotubes, EC_{50} of the COOH-terminal, 95-kD fragment of agrin_{A4B8} was ~ 35 pM, of agrin_{A4B19} ~ 110 pM and of agrin_{A4B11} ~ 5 nM. While some AChR clusters were observed with 64 nM of agrin_{A4B0}, no activity was detected for agrin_{A0B0}. Recombinant full-

length chick agrin and a 100-kD fragment of ray agrin showed similar EC_{50} values. A 45-kD, COOH-terminal fragment of agrin_{A4B8} retained high activity ($EC_{50} \cong 130$ pM) and a 21-kD fragment was still active, but required higher concentrations ($EC_{50} \cong 13$ nM). Unlike the 45-kD fragment, the 21-kD fragment neither bound to heparin nor did heparin inhibit its capability to induce AChR aggregation. These data show quantitatively that agrin_{A4B8} and agrin_{A4B19}, expressed in motor neurons, are most active, while no activity is detected in agrin_{A0B0}, the dominant isoform synthesized by muscle cells. Furthermore, our results show that a fragment comprising site B₈ and the most COOH-terminal G-like domain is sufficient for this activity, and that agrin domains required for binding to heparin and those for AChR aggregation are distinct from each other.

THE formation of chemical synapses in the nervous system requires exchange of local signals between pre- and postsynaptic cells. At the neuromuscular junction (NMJ)¹, muscle cells aggregate several proteins, such as acetylcholine receptors (AChRs), acetylcholinesterase, and heparan sulfate proteoglycans at the site of contact between nerve and muscle cell. This process is, at least in part, initiated by the release of molecules from the motor axon. Several lines of evidence suggest that agrin, a component of synaptic basal lamina, is such a molecule. On cultured myotubes, agrin induces aggregation of several molecules that are concentrated at the NMJ including AChRs (Nitkin et al., 1987; Wallace, 1989). Motor neurons synthesize agrin, transport it to the nerve terminal from where it is released to induce AChR aggregation (Magill-Solc and McMahan, 1988, 1990; Reist et al., 1992; Cohen and Godfrey, 1992).

Please address all correspondence to Dr. Markus A. Ruegg, Department of Pharmacology, Biozentrum, University of Basel, Klingelbergstrasse 70, CH-4056 Basel, Switzerland. Tel: 41 61 267 2246 or 41 61 267 2213. Fax: 41 61 267 2208.

1. *Abbreviations used in this paper:* AChR, acetylcholine receptor; NMJ, neuromuscular junction.

cDNAs encoding agrin have been cloned in rat, chick, and the marine ray (Rupp et al., 1991; Tsim et al., 1992; Smith et al., 1992). The deduced protein from full-length cDNAs of rat and chick has a calculated M_r of more than 200 kD. It contains several domains that are homologous to motifs found in other proteins of the extracellular matrix. Within the COOH-terminal half of agrin, two sites are altered as a result of alternative mRNA splicing (Ruegg et al., 1992; Rupp et al., 1992). In chick, the sites are referred to as site A and site B (Ruegg et al., 1992); the same sites in rat are called γ and z (Hoch et al., 1993). Site A encodes 4 amino acids and site B codes for either 8, 11, or 19 (8 + 11) amino acids. By PCR techniques, it has been shown in chick and rat that isoforms containing inserts at the B-site always carry inserts at the A-site (Ruegg et al., 1992; Hoch et al., 1993). Thus, alternative mRNA splicing at the two sites is coordinated and thereby the number of agrin transcripts expressed *in vivo*, that differ at sites A and B, is restricted to five. In this report we refer to the isoforms encoded by these transcripts as agrin_{A0B0}, agrin_{A4B0}, agrin_{A4B8}, agrin_{A4B11}, and agrin_{A4B19}. Alternatively spliced mRNAs are expressed tissue specifically and depend upon the developmental stage. Single cholinergic neurons of chick ciliary ganglia contain mixtures of mRNAs encoding B₀, B₈, B₁₁, and B₁₉ inserts.

The relative amount of each transcript varies during development, nevertheless the most abundant mRNA at embryonic days 6–20 encodes agrin_{A4B19} (Smith and O'Dowd, 1994). At embryonic days 5 and 6, chick motor neurons also express high levels of agrin_{A4B19} (Ruegg, M. A., M. J. Werle, S. E. Horton, L. S. Honig, and U. J. McMahan, manuscript in preparation). Transcript specific *in situ* hybridizations indicated that, later in development, agrin_{A4B19} mRNA is down-regulated and mRNA for agrin_{A4B8} becomes most abundant in motor columns (Honig, L. S., D. Stone, K. Nikolics, and U. J. McMahan, 1993. *Soc. Neurosci. Abstr.* 1272). Thus, cholinergic neurons express a mixture of agrin isoforms and depending on the developmental stage, agrin_{A4B8} or agrin_{A4B19} is most abundant. Nonneuronal and muscle cells, on the other hand, express only mRNA encoding agrin_{A4B0} and agrin_{A0B0} (Ruegg et al., 1992; Hoch et al., 1993; Ma et al., 1994; Smith and O'Dowd, 1994).

The COOH-terminal half of agrin_{A4B11} is sufficient to induce AChR clustering on cultured primary myotubes and this activity is indistinguishable from that of purified *Torpedo* agrin (Tsim et al., 1992). When tested in a qualitative way, this activity was dependent on the presence of amino acids at both sites A and B (Ruegg et al., 1992). Similarly, AChR-aggregating activity of rat agrin differs between isoforms, although the extent of the changes in activity depended on the experimental conditions, such as the origin of muscle cells and the size of rat agrin (Ferns et al., 1992, 1993).

Several lines of evidence suggest that agrin binds to receptors on the muscle cell surface and that aggregation of AChRs is mediated by an intracellular cascade. Before aggregation the β subunit of the AChR becomes tyrosine phosphorylated (Wallace et al., 1991). Staurosporine, a non-selective antagonist of protein kinases, blocks both phosphorylation of the β subunit and AChR aggregation (Wallace, 1994), supporting the view that phosphorylation and aggregation of AChRs are causally linked.

Evidence for an agrin-binding site on muscle cells has been published by Nastuk et al. (1991). This binding protein has been characterized biochemically from postsynaptic membranes of the electric organ of *Torpedo californica* (Ma et al., 1993; Bowe et al., 1994). Peptides derived from this binding protein are highly homologous to α -dystroglycan (Bowe et al., 1994). Indeed, recent experiments have shown that an \sim 100-kD fragment of rat agrin binds specifically to this peripheral membrane protein on muscle cells. Its binding is Ca²⁺-dependent and is inhibited by low concentrations of heparin (Campanelli et al., 1994; Gee et al., 1994; Sugiyama et al., 1994). α -Dystroglycan is a component of the dystrophin-glycoprotein complex, which forms, via dystrophin, a network with the cytoskeleton. Earlier studies showing that laminin binds to α -dystroglycan (Ibraghimov-Beskrovnya et al., 1992) suggested that the dystrophin-glycoprotein complex links basal lamina and cytoskeleton of muscle cells to confer physical stability of the sarcolemma and to guarantee maintenance of calcium homeostasis during contractions (for a recent review see Matsumura and Campbell, 1994). The finding that agrin binds to α -dystroglycan has suggested that this protein complex may also be important for the formation of the NMJ. A question that remains is whether binding of α -dystroglycan induces the intracellular signaling cascade that triggers aggregation of

AChRs on cultured muscle cells (see also Sealock and Froehner, 1994; Sugiyama et al., 1994).

The aim of our work was (a) to determine quantitatively the activities of agrin isoforms synthesized by neurons and by nonneuronal cells and (b) to establish how individual domains of agrin contribute to its AChR-aggregating activity. Our results show that agrin isoforms with the 8-amino acid insert at site B are most active, while absence of amino acids at this site lowers the activity by more than three orders of magnitude. Furthermore, we show that a COOH-terminal, 21-kD fragment of agrin is sufficient for this activity. AChR aggregation induced by this fragment is not inhibited by heparin. Hence, the heparin-binding site of agrin is not required to activate the signal-transducing receptor.

Materials and Methods

Polymerase Chain Reaction and Oligonucleotides

Conditions for PCR were as follows: 20 mM Tris-HCl (pH 8.4), 50 mM KCl, 2.5 mM MgCl₂, 0.2 mM of each dNTP, 50 pmol of each primer and 2.5 U of Taq polymerase (GIBCO BRL, Gaithersburg, MD). Reaction volume was usually 100 μ l. Numbering of oligonucleotides is according to the sequences published by Tsim et al. (1992) and Smith et al. (1992). All PCR products used to generate expression constructs were cloned into PCR 1000 or PCR II cloning vectors (Invitrogen, San Diego, CA) and sequenced to ensure that no mutations were introduced by DNA amplification. To distinguish expression constructs and recombinant protein, cDNA constructs are named with the prefix *p* followed by the name of the recombinant protein they encode.

Identification of Splice Variants in Chick and the Marine Ray

Reverse transcriptase-polymerase chain reaction was conducted as described by Tsim et al. (1992). For chick, poly (A)⁺ RNA from embryonic day 10 dorsal root ganglia served as a template, while for the marine ray, mRNA isolated from electric lobe of adult *Discopyge ommata* was used. Oligonucleotides used for chick were s5381 (TTT GAT GGT AGG ACG TAC AT) and as5491 (CTT CTG TTT TGA TGC TCA GC); for the marine ray s3451 (GGG CGC ACA TTC ATT GAG TAT CAC) and as3511 (TTC AAA ATA ATT AAC TTG T). PCR products were cloned into PCR 1000 (Invitrogen) and sequenced using Sequenase 2.0 (USB, Cleveland, OH). The chick sequence of B₁₉ was identical to that submitted to the GenBank by Thomas et al. (1993). The protein sequence for B₈ of *Discopyge ommata* has been published by McMahan et al. (1992). Nucleotide sequence data are available from EMBL/GenBank/DBJ under accession number U16146.

Expression Constructs

Constructs Encoding the 95-kD Fragment of Chick Agrin. All agrin constructs used in this work contain an artificial ER signal sequence derived from hemagglutinin of the avian influenza virus described by Tsim et al. (1992). This signal sequence was inserted into the expression vector pcDNA1 (Invitrogen).

The constructs encoding the COOH-terminal half of chick agrin (c95) are based on ARP-2_{cDNA} (Ruegg et al., 1992). Pc95_{A4B11} was generated as previously reported (Ruegg et al., 1992). The insert for pc95_{A4B19} was obtained by fusion of overlapping DNA fragments derived from CBA-1 (Tsim et al., 1992) and the cloned PCR product encoding the B₁₉ isoform (see above). The fused DNA fragment, spanning nucleotides 5023–5827 in chick agrin, was cloned into PCR 1000 (Invitrogen) and a cDNA fragment with the B₁₉ site was excised by XhoI and ApaI restriction endonucleases and was inserted into pc95_{A4B11} as previously described (Ruegg et al., 1992). Pc95_{A4B8} was obtained by fusing overlapping PCR products. To achieve this, a XhoI-ApaI restriction fragment of pc95_{A0B0} was inserted into Bluescript vector KS⁺ (Stratagene Corp., La Jolla, CA). PCR was performed using T3 as a sense primer (ATT AAC CCT CAC TAA AGG GA) and the antisense primer as5408_B8 (GGG ATC TCA TTG CTC AGG

TGG CTC TTT GTC ACG GCA TTG T). The second reaction was made using T7 primer (TAA TAC GAC TCA CTA TAG GG) and the sense oligonucleotide B8_s5457 (ACC TGA GCA ATG AGA TCC CTG CCG AGA AGG CTT TGC AAT CC). After isolation from agarose gel, the two fragments were fused by PCR amplification in the presence of T3 and T7 primer. The PCR product was purified, cut with XhoI and ApaI restriction endonucleases, and exchanged with the corresponding fragment in *pc95_{A4B1}*. *Pc95_{A4B0}* was made by replacing a ClaI-XbaI fragment of *pc95_{A4B1}* with the corresponding fragment obtained from ClaI-XbaI digestion of ARP-1_{cDNA} (Ruegg et al., 1992).

Construction of Full-Length Chick Agrin. cDNA clones PE-3 and PE-1 that encode the 5' end of chick agrin (Tsim et al., 1992) were joined by PCR: Amplification was conducted on PE-3 with s6 (CCT TAA TCT GTG ACA AC) and as934 (CCA CCG CTT CAG GCA GCG AGC) as primers, and on PE-1 with s903 (GGA CAA ATG CAA GGA TG) and as1662 (GGC AGG AGG CTG CTC GG) as primers. Both PCR products were gel purified and fused by DNA amplification using primers s6 and as1662. The resulting PCR products were inserted into PCR 1000 vector (Invitrogen) and several clones were sequenced. One clone with no mutations was joined with PE-1 by restriction digestion with ApaI and ligation with the insert of PE-1, cut with ApaI. The resulting insert in PCR 1000 comprised agrin sequences from nucleotide 6-3690. This clone was subsequently digested with BamHI and ligated to CBA-1 (Tsim et al., 1992) that had been cut with the same restriction endonuclease. Clones were screened for the correct orientation and the insert comprising full-length chick agrin was moved into the expression vector pcDNA1 by excision with EcoRI.

To facilitate work with this expression construct the BamHI restriction site, located in the polylinker at the 5' end of full-length agrin, and the EcoRI-site at the 3' end were both destroyed by restriction digest with the corresponding endonuclease, followed by filling recessed ends by treatment with Klenow polymerase and religation. This led to a full-length cDNA construct (*pCA*) with a unique EcoRI site at its 5' end and a unique XbaI site at its 3' end. Exchange of the endogenous, putative signal sequence with the hemagglutinin signal sequence was achieved as follows: PCR was conducted on *pCA* and primers EcoRI_s193 (AGC TTG AAT TCG AAG CCC AAT AGC TAT TTT ACC CAG) and as1036 (TTT CTG CCG CTC ACA GTC ATT). The resulting PCR product was gel purified, digested with EcoRI and BssHII, and inserted into the EcoRI/BssHII cut *pCA*. Fusion to the artificial signal sequence was completed by cutting the PCR-modified, full-length cDNA with EcoRI and XbaI restriction enzymes and ligating the insert into pcDNA1 containing the signal sequence giving rise to *pcFull_{A4B1}*. Constructs with different B-sites were generated by exchanging ClaI-SmaI restriction fragments isolated from the corresponding *pc95*-constructs. *PcFull_{A0B0}* was obtained by replacing the BamHI-XbaI fragment in *pcFull_{A4B1}* with the corresponding fragment of ARP-2_{cDNA} (Ruegg et al., 1992).

Constructs Encoding 45 kD and 21 kD Fragments. *Pc45* constructs were generated by PCR using *pc95_{A4B8}* as template together with the oligonucleotides EcoRI_s4648 (AGC TTG AAT TCG GAG CAG GAC CAC ACC A) and an antisense primer corresponding to the nucleotide sequence of B₈, as-B8 (GCA GGG ATC TCA TTG CTC AGG TGG). The PCR product was gel purified, digested with EcoRI and ClaI, and inserted into *pcFull_{A4B8}* or *pcFull_{A0B0}*, respectively. *Pc21_{B8}* and *pc21_{B0}* were generated by PCR using *pc45_{A4B8}* and *pc45_{A0B0}* as templates together with EcoRI_s5351 (AGC TTG AAT TCA GCT GGA GAT GCA GAG G) and as6146_XbaI (CCG GGT CTA GAC TTG GTT CAA GGT TT). PCR products were purified from agarose gels and digested with EcoRI and XbaI. After isolation from agarose gels, fragments were ligated into EcoRI-XbaI cut pcDNA1 expression vector containing the signal sequence. The complete coding region was sequenced in order to verify the PCR fragment.

Constructs Encoding 100 kD Fragment of the Marine Ray. To generate an expression construct, the partial cDNA clone OL4 encoding agrin_{A4B0} of *Discopyge ommata* (Smith et al., 1992) served as template. cDNA was digested with NarI and recessed ends were filled with Klenow polymerase. After digestion with XbaI restriction endonuclease and purification on agarose gel, the fragment was inserted into pcDNA1 containing the signal sequence that had been cut with EcoRI, filled with Klenow polymerase and redigested with XbaI. This procedure yielded *pr100_{A4B0}* encoding recombinant agrin_{A4B0} that is 35 amino acids longer than the 95-kD fragment isolated from basal lamina extracts of the electric organ of *Torpedo californica* (for NH₂ terminus of the 95-kD fragment, see Smith et al., 1992). To generate *pr100_{A4B8}*, *pr100_{A4B0}* was digested with HindIII restriction endonuclease and inserted into HindIII-cut pcDNA1. A first PCR was performed on this construct with T7 and as3479_B8 (TGG GAT

CTC ATT TGC AAG ATG GCT CCT TGT CAC TGT GTT GT) as primers. A second PCR on the same template used SP6 (CAT TTA GGT GAC ACT ATA G) and B8_s3498 (ATC TTG CAA ATG AGA TCC CAG ATG AGA AAG CTG TAC AAG TT) as primers. After purification, the two products were fused in a third amplification using primers T7 and SP6. The PCR product was cloned into PCR II vector (Invitrogen), digested with both Eco47III and SphI, and the resulting DNA fragment was exchanged with the corresponding fragment of *pr100_{A4B0}*.

Tissue Cultures

Chick Myotube Cultures. Myotube cultures were prepared from hind limb muscles of 11–12-d White Leghorn chick embryos by the method of Fischbach (1972). Modifications of these procedures were as follows: freshly dissociated myoblasts were plated in a density of $\sim 1.5 \times 10^5$ cells onto 35-mm plastic tissue culture dishes previously coated with 0.3 mg gelatin (Sigma Chem. Co., St. Louis, MO). Growth medium consisted of MEM (GIBCO BRL) supplemented with 10% horse serum (GIBCO BRL), 4% chick embryo extract (prepared from 11-d-old chick embryos with an equal volume of Puck's saline G [Puck et al., 1958]), 100 U/ml penicillin (GIBCO BRL) and 100 μ g/ml streptomycin (GIBCO BRL). After 2.5 d, growth medium was replaced by differentiation medium consisting of growth medium with only 2% chick embryo extract and 0.5×10^{-5} M cytosine arabinoside (Sigma Chem. Co.). Cultures were used 3.5–4.5 d after plating.

C2C12 Cell Line. C2C12 cells were proliferated in DME containing 10% horse serum (GIBCO BRL), 10% newborn calf serum, 100 U/ml penicillin, and 100 μ g/ml streptomycin. Approximately 0.5×10^5 cells were plated on gelatin-coated 35-mm tissue culture dishes and after one day, medium was replaced with DME containing 2% FCS (GIBCO BRL), 100 U/ml penicillin, and 100 μ g/ml streptomycin. After 4–6 d, cells had fused and AChR aggregation assays were performed.

Transfection and Culturing of COS-7 and 293 Cells. COS-7 (Gluzmann, 1981) and 293 (Graham et al., 1977) cells were cultured in DME (GIBCO BRL) supplemented with 10% newborn calf serum, 10 mM sodium pyruvate, 100 U/ml penicillin, and 100 mg/ml streptomycin (all from GIBCO BRL). COS-7 cells were transiently transfected with the DEAE-dextran-based method described by Cullen (1987). 293 cells were transfected by the method described by Gorman et al. (1990). Supernatants were usually collected 3 d after transfection.

To establish stably transfected cell lines, 293 cells that had been plated onto a 100-mm tissue culture dish at 70% confluence were transfected with agrin constructs together with 1/10 of a helper plasmid (pRSV-T_{neo}; Gorman et al. [1990]) that carried a neomycin resistance gene. One day after transfection, cells were plated onto two or three 100-mm culture dishes and 600 μ g/ml G418 (GIBCO BRL) was added to the medium. After 2–3 wk, individual colonies were picked and stained intracellularly with mAb 5B1 or the polyclonal anti-agrin antiserum. Colonies expressing high levels of recombinant agrin were cloned by limited dilution into 96-well plates. Positive clones were selected and grown in medium without G418.

Quantification of AChR Aggregation

Chick muscle cells or C2C12 myotubes were incubated with agrin for 16 h at 37°C. In experiments where the effect of heparin (grade I, Sigma Chem. Co.) on AChR aggregation was measured, muscle cells were exposed to agrin for only 6 h under serum-free conditions as described (Wallace, 1988). Cells were then rinsed with DME-F12 (Sigma), 1 mg/ml BSA (Fluka, Buchs, Switzerland), and incubated in the same medium containing 4×10^{-8} M rhodamine- α -bungarotoxin (Molecular Probes, Eugene, OR) for 45–60 min at 37°C. Cultures were washed twice with DME-F12, 1 mg/ml BSA followed by one rinse with MEM. They were fixed with 95% ethanol for 5 min at -20°C and mounted on glass coverslips with 90% glycerol, 10% PBS. Cultures were examined at a magnification of 400 \times on a microscope equipped with epifluorescence (AH-2; Olympus Optical Co., Tokyo, Japan). To determine the extent of AChR clustering, segments of healthy myotubes were chosen under phase optics, and both phase and rhodamine optics were imaged with a SIT-camera (model 66; Dage-MTI, Michigan City, IN) that was connected to an imaging system (Image-1/AT; Universal Imaging, West Chester, PA). The threshold of the digitized images was set by eye such that AChR aggregates were clearly distinct from background labeling of myotubes. The threshold was kept constant throughout the analysis of one series of experiments. Myotubes were outlined manually and AChR aggregates (i.e., objects above threshold) were counted within the outlined area. Only AChR aggregates with a longer axis of at least 4 μ m were included in the counting. For chick myotubes, data were ex-

pressed as number of AChR aggregates in a normalized area ($100 \mu\text{m} \times 100 \mu\text{m}$) of a myotube segment. Because of the shape of AChR aggregates on C2C12 cells, the ratio of areas occupied by AChR aggregates to total area of the myotube segment proved to be more accurate as a measure of agrin's activity. In each 35-mm culture dish, 10 individual myotube segments were counted. Pictures taken in phase optics were used to exclude non-specifically labeled cell debris.

Antibodies

mAb 5B1 (Reist et al., 1987) was a kind gift of Dr. U. J. McMahan (Department of Neurobiology, Stanford University School of Medicine, CA). To purify IgGs, hybridomas were grown in DME containing 10% IgG-depleted FCS (GIBCO BRL). Conditioned medium was buffered with 20 mM Hepes (pH 7.2) and applied to protein G-Sepharose (Pharmacia, Uppsala, Sweden). After washing with 20 mM sodium phosphate, pH 7.0, IgGs were eluted with 100 mM glycine-buffer (pH 2.7) and immediately neutralized by adding 1/10 vol of 1 M Tris-HCl (pH 7.0). Polyclonal antisera were raised in two rabbits by injecting immunofluorescence-purified c95_{A4B11}. For the first injection $\sim 60 \mu\text{g}$ of protein in complete Freund's adjuvant were used. For booster injections in 4–8-wk intervals, the same amount of c95_{A4B11} was dissolved in incomplete Freund's adjuvant. Titer of anti-c95_{A4B11} IgG in the sera was determined by immunoprecipitation of agrin-containing medium of stably transfected 293 cells and by staining cryostat-sections of embryonic day 18 chick pectoral muscle.

Purification of Recombinant Agrin. mAbs 5B1 were covalently coupled to Affi-10 beads (BioRad Labs, Hercules, CA) according to the manufacturer's instruction. Conditioned media of transiently or stably transfected cells was loaded onto the column with a flow rate of $\sim 20 \text{ ml/h}$. The column was washed sequentially with 20 vol each of 50 mM Tris buffer, pH 7.5, containing 150 mM NaCl, 5% glycerol, 0.5% Triton X-100; Tris buffer containing 1 M NaCl, 5% glycerol and 0.5% Triton X-100 and Tris buffer containing 150 mM NaCl and 5% glycerol. Columns were eluted with 10 vol of 50 mM triethylamine, pH 11.5, containing 150 mM NaCl and 5% glycerol. Fractions (1.5 ml) were collected and immediately buffered with 180 μl of 1 M Tris-HCl, pH 7. Aliquots of each fraction were analyzed on 7.5% SDS-PAGE and proteins were visualized by silver staining (Morrisey, 1981). Fractions with high concentrations of agrin were pooled and dialyzed three times against 1.5 liter of PBS. Centricon-30 concentrators (Amicon Corp., Danvers, MA) were used to concentrate agrin. Agrin concentration was determined according to Lowry et al. (1951) using the DC Protein assay kit (BioRad Labs) and BSA as a standard. As an independent measure, the relative intensity of agrin on silver-stained gels was estimated by dilution series of known amounts of bovine serum albumin. Highly pure fractions with known concentrations of agrin were used as internal standards in the ELISA.

Agrin Binding to Heparin Columns. 2 ml of heparin (type II)-agarose beads (Sigma Chem. Co.) were used as heparin affinity columns. 2.5 ml of ³⁵S-labeled conditioned media from COS cells transfected with pc45_{A4B8} or pc21_{B8} were loaded onto separate heparin columns. Bound proteins were eluted with 2.5 ml of 50 mM Tris-HCl, pH 7.5, containing 500 mM NaCl, and 5% glycerol. Aliquots of the flow through and the eluate were immunoprecipitated as described below.

Quantification of Agrin

ELISA. ELISA was essentially done as described by Ruegg et al. (1989) with the following modifications: mAb 5B1 (10 $\mu\text{g/ml}$) was immobilized on microtiter plates followed by incubation of c95 proteins at a concentration between 0.5 and 10 ng/ml. As a secondary antibody, purified rabbit anti-c95_{A4B11} IgG at a concentration of 5.6 $\mu\text{g/ml}$ was used. To eliminate cross-reactivity of IgG with 5B1, antiserum was always preadsorbed with 5B1 beads. The third antibody, a peroxidase-conjugated goat anti-rabbit IgG (BioRad Labs) was used in a 1:2,000 dilution. The detection limit of this procedure was $\sim 50 \text{ pg}$ of agrin. As an internal standard, purified recombinant c95 protein with known concentration (see above) was used.

Metabolic Labeling, Immunoprecipitation, and Quantification. Independent of ELISA, concentrations of recombinant agrin in conditioned medium of transfected cells was determined as follows: six hours after transfection, medium was changed to 25% DME, 65% MEM without methionine, 10% IgG-depleted FCS (all from GIBCO BRL) and 50 $\mu\text{Ci/ml}$ [³⁵S]methionine (Du Pont, Bad Homburg, Germany). Cells were grown in this medium for 2.5 d. Except for c45 and c21-containing medium, aliquots were removed for independent measure of the agrin concentration by ELISA. Aliquots used for immunoprecipitations were 300 μl (c95-fragments) and 30 μl (c45- and c21 proteins). Volumes were adjusted to 1

ml with a 50-mM Tris-HCl buffer, pH 7.5, containing 5% glycerol and 150 mM NaCl and 10 μl of rabbit anti-agrin antisera was added. After incubation for 3 h at 4°C, 60 μl of a 30% suspension of protein A-Sepharose (Pharmacia) in 0.14 M sodium phosphate, pH 8.3, was added and incubation was continued for an additional 90 min. Supernatant was removed and subjected to a second immunoprecipitation to guarantee that agrin had been depleted in the first round by at least 90%. The beads were then washed sequentially as described for immunoaffinity columns, except that NaCl was raised only to 625 mM. Bound antigen-antibody complexes were released by boiling for 5 min in 60 μl of SDS-PAGE sample buffer (Laemmli, 1970). Samples were separated by SDS-PAGE on a 3–12% gradient gel. Gels were dried and the amount of [³⁵S] incorporated into recombinant agrin was quantified by volume integration with a PhosphorImager (Molecular Dynamics, Sunnyvale, CA). To calculate the molar amount of different agrin fragments, the radioactivity incorporated was corrected with the number of methionines present in different agrin fragments. Concentrations of c45 and c21 in conditioned medium was determined by comparison of incorporated radioactivity with that of immunoprecipitated c95_{A4B8}, whose concentration had also been determined by ELISA.

Results

cDNA Constructs, Heterologous Expression, and AChR-clustering Activity of Agrin Isoforms

Most studies of the molecular mechanisms of agrin-induced AChR aggregation and of the binding properties of agrin have used purified protein from the electric organ of *Torpedo californica* (e.g., Wallace, 1988, 1989; Wallace et al., 1991; Ma et al., 1993). The main protein containing AChR-aggregating activity in these fractions has an apparent M_r of 95 kD (Nitkin et al., 1987). To compare activities of agrin isoforms with previous results, we used ARP-2_{CDNA} (Ruegg et al., 1992) as a template. The protein encoded by ARP-2_{CDNA} is expected to have the same size as the 95-kD protein from *Torpedo californica*. We also tested whether regions in the NH₂-terminal half of full-length agrin would affect activity by generating cDNA constructs that encode the complete amino acid sequence of the mature chick agrin protein (Tsim et al., 1992). Finally, we generated constructs encoding recombinant agrin_{A4B0} and agrin_{A4B8} of the electric ray, *Discopyge ommata*, to compare activity of agrin isoforms from different species. The structure of recombinant agrin fragments and their nomenclature is shown in Fig. 1.

Recombinant protein was obtained by transfecting cDNA constructs into COS-7 (Gluzman, 1981) or 293 cells (Graham et al., 1977). Recombinant agrin in the conditioned medium was identified by immunoprecipitation with mAb 5B1 (Reist et al., 1987) or a polyclonal antiserum raised against recombinant c95_{A4B11}. Fig. 2 shows a fluorogram of the recombinant proteins that had been resolved by SDS-PAGE. The apparent M_r of $\sim 95 \text{ kD}$ of recombinant chick c95 proteins fits well with the predictions from protein purified from *Torpedo californica*. Recombinant agrin encoded by the ray cDNA, r100_{A4B8}, has an apparent M_r of $\sim 100 \text{ kD}$, which is expected because it is 44 amino acids longer than the corresponding c95-isoform in chick (Fig. 2). Recombinant full-length chick agrin, whose putative signal sequence had been replaced by the signal sequence of hemagglutinin of the influenza virus, is secreted efficiently by COS and 293 cells. It migrates on SDS-PAGE as a broad smear with an apparent M_r of 400–600 kD (Fig. 2). Deglycosylation experiments with heparitinase, chondroitinase ABC, and keratanase indicate that recombinant chick agrin is a heparan sulfate proteoglycan (Denzer, A. J., M. Gesemann, and M. A. Ruegg, unpublished observation).

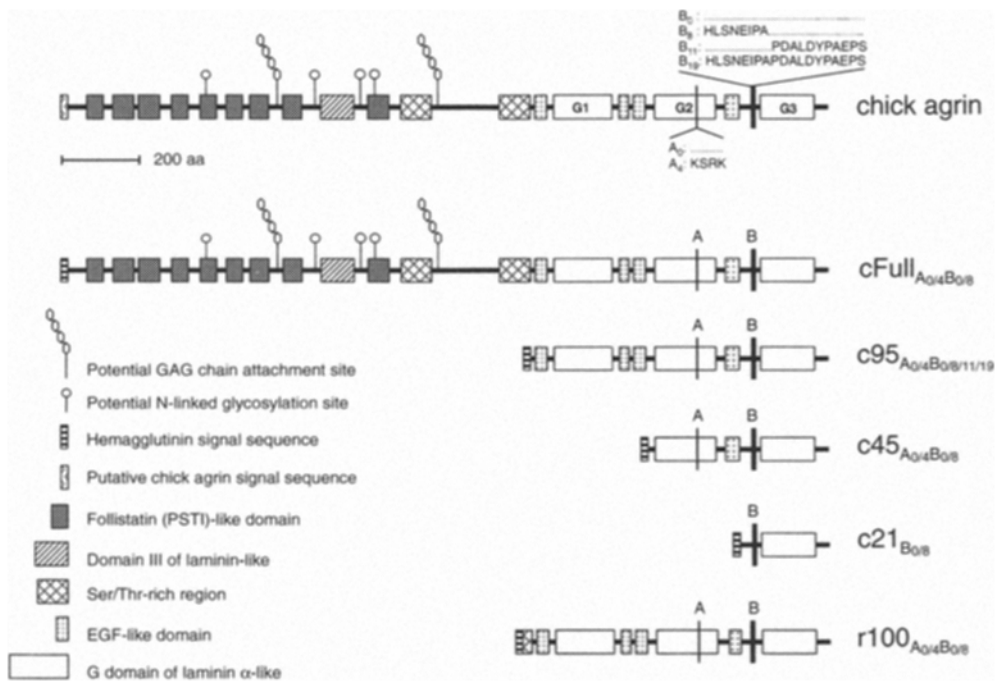

Figure 1. Structural domains of chick agrin and of recombinant fragments used in this study. Domains, potential sites for N-glycosylation and glycosaminoglycan side chain attachment, and location of sites A and B including amino acid sequences are shown. Names of agrin fragments are indicated.

Consistent with this observation, several potential glycosaminoglycan side chain attachment sites (Bourdon et al., 1987) are found in agrin and the positions of some of these sites are conserved in chick, rat, and electric ray (see Fig. 1). The possibility that agrin exists *in vivo* as heparan sulfate proteoglycan is substantiated by the findings of Hagen et al. (1993), who characterized heparan sulfate proteoglycans from bovine renal basement membranes. Two tryptic peptides from a purified proteoglycan are highly homologous to rat and chick agrin, suggesting that, at least in kidney, agrin may be a heparan sulfate proteoglycan.

To measure the concentration of recombinant agrin in the conditioned medium of transfected cells, we established an ELISA using mAb 5B1 and polyclonal anti-c95_{A4B11} antisera. The accuracy of this method was tested by comparing the results from the ELISA with those obtained by immunoprecipitation of ³⁵S-agrin. As shown in Table I, the two methods yielded the same results for chick agrin isoforms irrespective of their size. The concentration of r100_{A4B8} determined by ELISA was only 60% of that obtained by immunoprecipitation, which is most likely due to the lower avidity of the anti-c95_{A4B11} antiserum to ray agrin. Thus, the ELISA is a valuable tool for determining the concentration of recombinant agrin in conditioned medium of transfected cells. Consequently, this method was used in the subsequent experiments.

First, we tested the effect of different agrin isoforms on the maximal number, size, and shape of AChR aggregates by incubating cultured chick myotubes for 16 h with excess of recombinant protein. AChRs were visualized using rhodamine-labeled α -bungarotoxin. As a control, conditioned medium of mock-transfected COS cells was added (Fig. 3 a). No AChR clustering was detected with 64 nM c95_{A0B0} (Fig. 3 b), while some activity was observed with this high concentration of c95_{A4B0} (Fig. 3 c). On the other hand, AChR aggregates were induced by c95_{A4B11} (Fig. 3 d), c95_{A4B19}

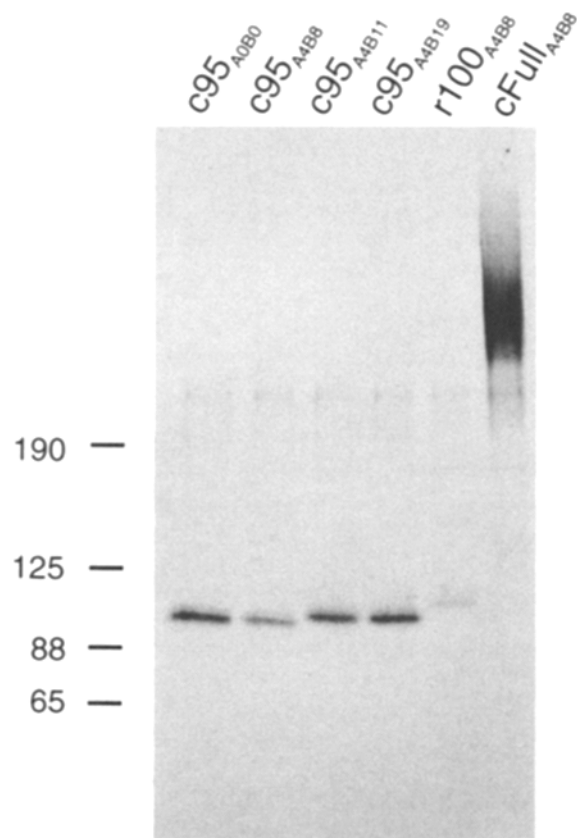

Figure 2. Autoradiogram of recombinant agrin fragments. Recombinant ³⁵S-agrin from transiently transfected COS-7 cells was immunoprecipitated by anti-agrin antiserum and separated on a 3–12% SDS-polyacrylamide gel. Names of the recombinant proteins are according to Fig. 1. Molecular weight of standard proteins used are shown. Note the apparent M_r of cFull_{A4B8} indicating its high content of carbohydrates.

Table 1. Comparison of Relative Concentrations of Recombinant Agrin Determined by ELISA and Immunoprecipitation

Protein	Relative amount determined by	
	ELISA	Immunoprecipitation
	mean \pm SEM	mean \pm SEM
c95 _{A4B19} *	89.8 \pm 4.5	97.3 \pm 2.6
c95 _{A4B11}	100	100
c95 _{A4B8} *	26.2 \pm 1.3	27.7 \pm 2.1
r100 _{A4B8} **	7.0 \pm 0.6	11.5 \pm 0.2
cFull _{A4B8} *	116.7 \pm 10.1	103.9 \pm 4.0

Relative amount of agrin in conditioned medium of COS cells that expressed the indicated fragments, was determined by ELISA and immunoprecipitation with anti-agrin antiserum. Incorporated radioactivity was determined by a PhosphorImager as described in Materials and Methods. The number of methionine-residues in the recombinant protein were used to calculate the amount for each fragment. Values are means \pm SEM of three independent experiments. Amount determined for c95_{A4B11} was set to 100%. Both methods give the same results for all chick fragments, while for ray agrin, ELISA detects only ~60% of the concentration determined by immunoprecipitation.

*, No significant difference between both methods ($p > 0.1$).

**, Significant difference ($p < 0.01$).

(Fig. 3 *e*), and c95_{A4B8} (Fig. 3 *f*). Recombinant chick cFull_{A4B8} and ray r100_{A4B8} were also active (Fig. 3, *g* and *h*). The maximal number, sizes, and shapes of AChR aggregates induced by the active agrin isoforms were the same (Fig. 3, *d-h*). Thus, the amino acid composition of site B and the length of chick agrin as well as species differences between chick and ray do not affect the extent of AChR aggregation and the appearance of the clusters.

We next determined dose response curves for the COOH-terminal, 95-kD fragments of each chick agrin isoform. The number of AChR aggregates per myotube induced by different concentrations of recombinant protein was measured with a computerized image analysis system. Spontaneously

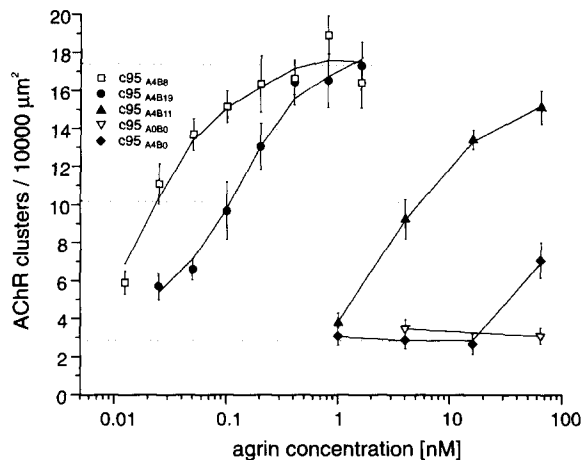

Figure 4. Dose response curves for AChR-aggregating activity of 95 kD, COOH-terminal fragment of agrin isoforms. Chick myotubes were incubated for 16 h with recombinant agrin isoforms at the concentrations indicated and the number of AChR clusters per myotube was determined as described in Materials and Methods. Area of the myotubes is normalized. Data points represent mean \pm SEM of duplicate cultures with 10 myotube segments counted in each. Dose response curves for each isoform show result of one representative experiment. No clustering activity was observed for c95_{A0B0}, while some AChR clusters were detected at 64 nM of c95_{A4B0}. The curve was fit to data points by eye. Number of AChR clusters without agrin, half-maximal and maximal number of clusters are indicated by dotted lines.

formed AChR aggregates, which are smaller in size than those induced by agrin (Fig. 3; Godfrey et al., 1984) were accounted for by excluding clusters in which the longer axis was less than 4 μ m. As shown in Fig. 4, the most active isoform on chick myotubes was c95_{A4B8}. Its EC₅₀ (effective concentration needed to induce a half-maximal response)

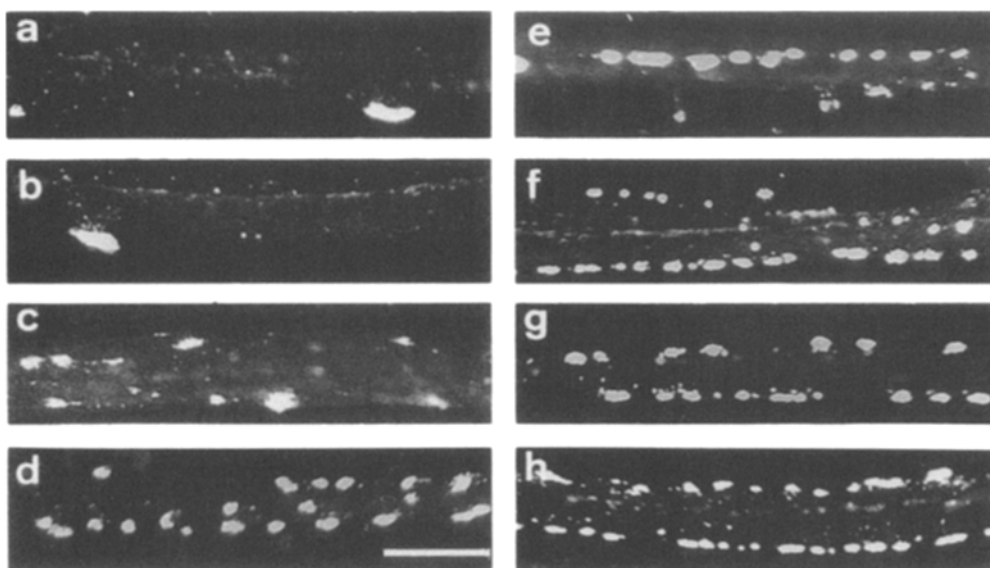

Figure 3. AChR-aggregating activity of agrin isoforms. Fluorescence micrographs of segments of cultured chick myotubes labeled with rhodamine- α -bungarotoxin. Only spontaneously formed AChR clusters were detected in myotubes incubated for 16 h with conditioned medium of COS cells that had been transfected with the vector alone (*a*) and 64 nM of affinity-purified c95_{A0B0} (*b*). Few AChR aggregates were seen after incubation with 64 nM of c95_{A4B0} (*c*). In contrast, active agrin isoforms (*d-h*) induced the formation of up to 20-fold more AChR aggregates than in control cultures. Concentrations and agrin fragments used were

64 nM c95_{A4B11} (*d*), 1.6 nM c95_{A4B19} (*e*), and 400 pM of each c95_{A4B8} (*f*), cFull_{A4B8} (*g*), and r100_{A4B8} (*h*). The sizes and shapes of AChR clusters induced by active agrin isoforms was independent of their composition at sites A and B (*d-f*), the size of agrin (*g*), and the species (*h*). Please note that spontaneous AChR aggregates in *a* and *b* are very frequent but are distinct from agrin-induced clusters by their smaller size. Bar, 40 μ m.

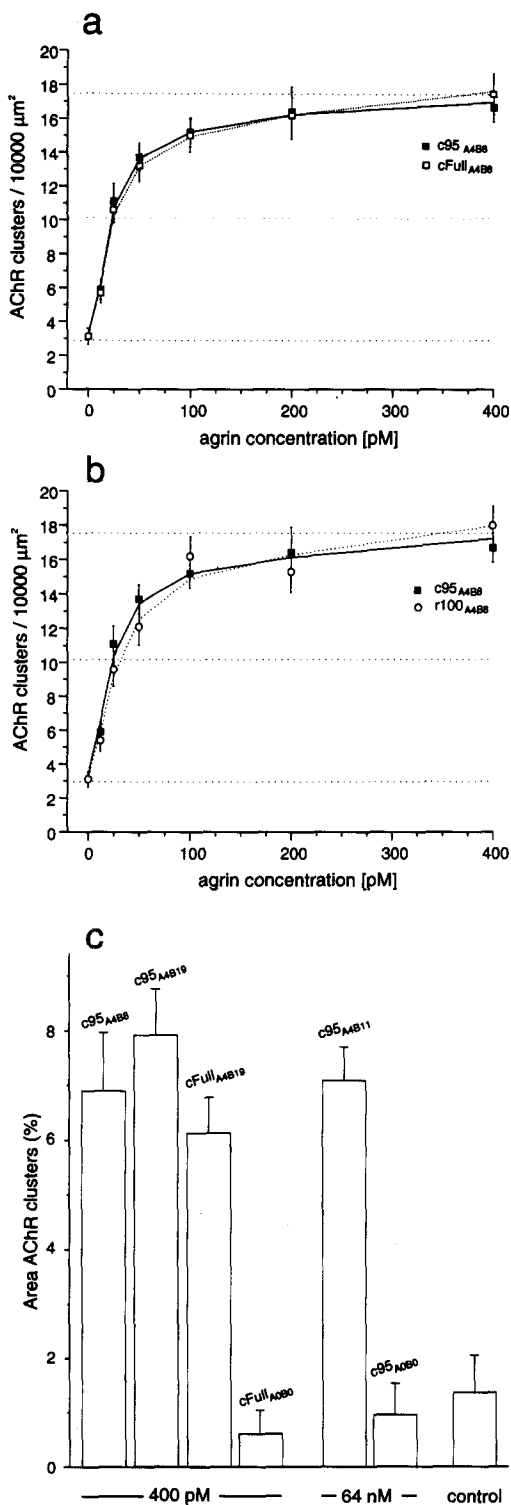

Figure 5. Comparison of AChR-aggregating activities of recombinant agrin isoforms. (a) AChR aggregation on primary chick myotubes induced by the COOH-terminal, 95 kD fragment, and full-length chick agrin_{A4B8} are very similar. (b) Dose response curves of COOH-terminal, 95 kD chick agrin_{A4B8} and a similar fragment of ray agrin_{A4B8} show that both species homologues are similarly active. (c) Response of C2C12 myotubes to different chick agrin isoforms. Because agrin-induced AChR aggregates are less frequent, but larger than on chick myotubes, agrin's activity is expressed as percentage area of AChR clusters. C2C12 myotubes respond to agrin isoforms similarly as primary chick myotubes. At

was 35 ± 3 pM (mean \pm SEM; $N = 4$). The second most active isoform was c95_{A4B19} with an EC₅₀ of 108 ± 12 pM (mean \pm SEM; $N = 3$), followed by c95_{A4B11} with 5 ± 1 nM (mean \pm SEM; $N = 3$). No detectable activity was observed with c95_{A0B0} even at concentrations of 64 nM. For c95_{A4B0}, we observed low levels of activity, but only at very high concentrations (64 nM). Some AChR-aggregating activity of affinity-purified agrin-like proteins from nonneurological tissue was observed by Godfrey (1991), which may be based on the presence of this weakly active agrin_{A4B0}.

To elucidate whether sequences in the NH₂-terminal half of chick agrin may contribute to its AChR-aggregating activity, we compared the dose response curves of the most active COOH-terminal half, c95_{A4B8}, with that of cFull_{A4B8}. As shown in Fig. 5 a, the two curves overlap almost perfectly. Like c95_{A0B0}, cFull_{A0B0} did not induce AChR aggregation at concentrations of up to 4 nM (4 nM of cFull_{A0B0}: 2.31 ± 0.34 AChR clusters/10,000 μm²; blank: 2.43 ± 0.27 AChR clusters/10,000 μm²). Thus, the presence of the NH₂-terminal half of chick agrin has no effect on AChR aggregation on chick myotubes.

Since most previous experiments on AChR aggregation used agrin purified from the electric ray, we also compared the activity of recombinant ray and chick agrin. We generated cDNA constructs encoding the COOH-terminal half of ray agrin_{A4B8} and agrin_{A4B0} using cDNA clone OL4 (Smith et al., 1992). When tested on chick myotubes, the dose dependence of AChR clustering induced by r100_{A4B8} was similar to that of c95_{A4B8} (Fig. 5 b). As expected from the results using recombinant chick agrin, no activity was detected with 4 nM of r100_{A4B0} (r100_{A4B0}: 1.93 ± 0.24 AChR clusters/10,000 μm²; blank: 1.79 ± 0.28 AChR clusters/10,000 μm²). If we account for the systematic error in determining the concentration of ray agrin by the ELISA (Table I), r100_{A4B8} is ~ 1.5 times less active than shown in Fig. 5 b. Nevertheless, these experiments show that homologous isoforms of the marine ray and chick have similar activities.

Activity of rat agrin isoforms depends on the myotubes on which they are tested. On primary rat myotubes and on the mouse C2C12 cell line, all rat agrin isoforms are active in aggregating AChRs (Ferns et al., 1992, 1993). On the other hand, on chick primary myotubes and on variants of the C2C12 cell line that are defective in glycosaminoglycan synthesis, only isoforms containing amino acids at sites A and B are active (Ferns et al., 1992, 1993). Although the EC₅₀ of different agrin isoforms were not determined, semiquantitative assays revealed that on the latter cells, rat agrin_{A4B8} and agrin_{A4B19} were more active than agrin_{A4B11}. To test whether the activity of chick agrin isoforms also depended on the myotubes, we determined the dose dependence of four agrin isoforms on myotubes formed by the C2C12 cell line

400 pM of agrin_{A4B8} (c95_{A4B8}) and agrin_{A4B19} (c95_{A4B19}; cFull_{A4B19}); and at 64 nM of c95_{A4B11}, maximal response is reached. No cluster-inducing activity is observed for 400 pM of cFull_{A0B0} and 64 nM of c95_{A0B0}. Each data point represents mean \pm SEM of duplicate cultures, where 10 myotube segments were counted in each. AChR clusters without agrin are given (control). Area of AChR clusters induced by c95_{A4B8}, c95_{A4B19}, cFull_{A4B19}, and c95_{A4B11} do not differ from each other ($p > 0.1$). Similarly, no significant difference to the control is observed in cultures treated with cFull_{A0B0} and c95_{A0B0}.

(Yaffe and Saxel, 1977; Blau et al., 1983). Since AChR aggregates on C2C12 myotubes were larger than those on chick myotubes (data not shown), the extent of AChR aggregation was expressed as the percentage area covered by AChR clusters. The EC_{50} of $c95_{A4B8}$ and $c95_{A4B19}$ was ~ 35 pM and that of $c95_{A4B11}$ was ~ 100 -fold lower (data not shown). As observed on chick myotubes, 400 pM of $c95_{A4B8}$, $c95_{A4B19}$, and $cFull_{A4B19}$ induced maximal response, while the same concentration of $cFull_{A0B0}$ failed to induce AChR clusters (Fig. 5 c). Consistent with the data on chick myotubes, $c95_{A0B0}$ did not induce detectable levels of AChR clusters and $c95_{A4B11}$ reached the same maximal response as the other active agrin isoforms (Fig. 5 c). In summary, induction of AChR aggregates on C2C12 myotubes by recombinant chick agrin closely followed that on chick primary muscle cells.

A Minimal Fragment with AChR-aggregating Activity

In a subsequent step we investigated which structural domains of agrin confer its AChR-aggregating activity. As a result of our studies on activities of agrin isoforms, we constructed deletion mutants of the most potent agrin isoform $agrin_{A4B8}$ and the inactive $agrin_{A0B0}$. The end point of the deletions was chosen to leave the different domains of agrin intact to promote proper folding of the recombinant protein. The first deletions started at amino acid 1487 of full-length

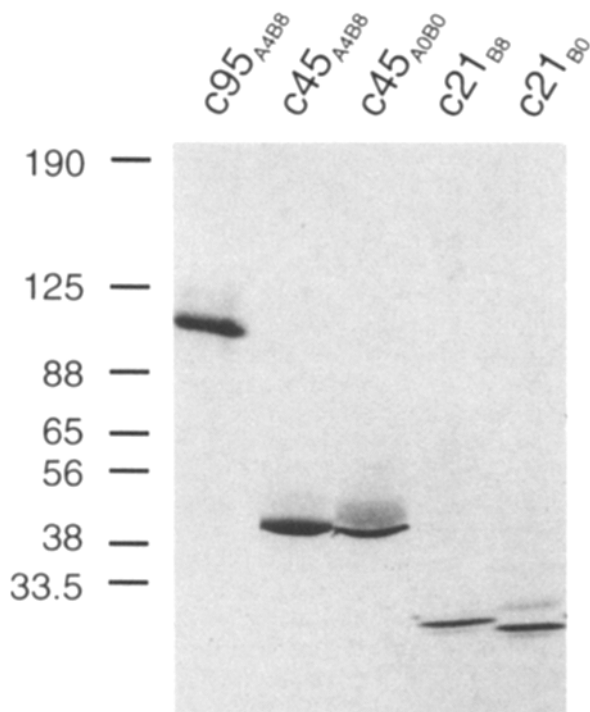

Figure 6. Autoradiogram of recombinant deletion mutants $c45$ and $c21$ of agrin. COS-7 cells expressing agrin fragments were labeled with [35 S]methionine, recombinant protein was immunoprecipitated with anti-agrin antiserum and resolved on a 3–12% SDS-polyacrylamide gel. Quantification of incorporated radioactivity by a PhosphorImager revealed that the average-ratio of concentration in the conditioned medium was $c95_{A4B8}:c45_{A4B8}:c21_{B0} = 1:20:30$. Migration of standard proteins with known molecular weight are indicated.

chick agrin (Tsim et al., 1992). They contained both sites A and B, two domains homologous to the G domain of laminin α -chains, and the last EGF-like repeat ($c45$; Fig. 1). The second deletions started at amino acid 1722 and contained the B-site and the last G domain ($c21$; Fig. 1). As shown in Fig. 6, both mutants are secreted efficiently from transiently transfected COS cells. The concentration of $c45$ - and $c21$ -proteins in the conditioned medium was assessed by immunoprecipitating metabolically labeled protein and comparing its [35 S] content with that of $c95_{A4B8}$ that had undergone identical treatment (Fig. 6). The absolute concentration of $c95_{A4B8}$ in the conditioned medium was determined by ELISA. In two independent experiments the ratio of $c95$: $c45$: $c21$ was 1:20:30. The increase in concentration for the small proteins $c45$ and $c21$ is expected and is an indication that the deletion mutants fold correctly and thus are not degraded intracellularly.

As shown in Fig. 7, the dose response curve of $c45_{A4B8}$ is slightly shifted compared to that of $c95_{A4B8}$. In three independent experiments, EC_{50} of $c45_{A4B8}$ was 132 ± 17 pM (mean \pm SEM; $N = 3$). Hence, $c45_{A4B8}$ is approximately fourfold less active than $c95_{A4B8}$. As observed for $c95_{A0B0}$, no activity was detected in $c45_{A0B0}$, even at concentrations of 100 nM. The smallest fragment, $c21_{B8}$, was still capable of inducing AChR aggregation, with an EC_{50} of 13 ± 4 nM (mean \pm SD; $N = 2$). Its activity depended on the presence of amino acids at the B-site, since $c21_{B0}$ failed to induce AChR clustering (Fig. 7). As was observed for agrin isoforms that have different EC_{50} values (Figs. 3 and 4), the maximal number of AChR clusters was the same for both $c45_{A4B8}$ and $c21_{B8}$. Thus, an agrin fragment containing the B₈-site and the most COOH-terminal G domain (G3) is

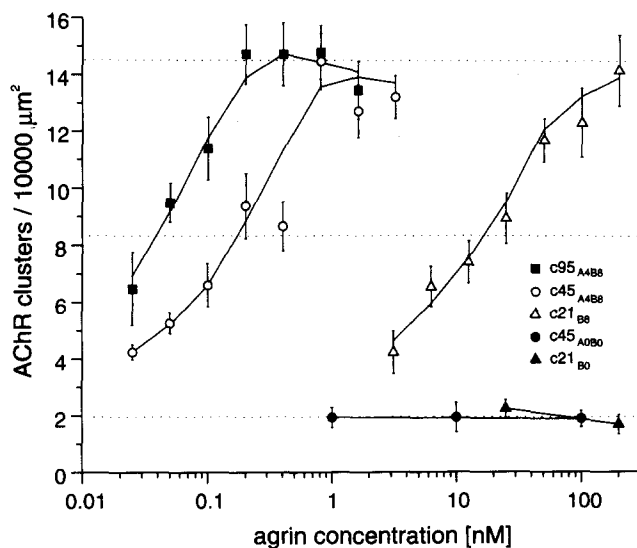

Figure 7. Dose response curves of deletion mutants of $agrin_{A4B8}$ and $agrin_{A0B0}$. Chick primary myotubes were incubated for 16 h with the concentration of recombinant agrin indicated. As a reference, dose response curve of $c95_{A4B8}$ is also shown. Each data point represents result (mean \pm SEM) from duplicate myotube cultures, 10 segments counted in each. Data shown represent results of one representative experiment. Curves were fit to data points by eye. Number of AChR clusters without agrin, half-maximal and maximal number of clusters are indicated by dotted lines.

sufficient to induce AChR aggregation. Its EC_{50} is two orders of magnitude higher, indicating that domain G2 and the last EGF-like repeat contribute to agrin's activity.

Exogenous heparin and other polyanions inhibit agrin-induced AChR aggregation (Wallace, 1990). Furthermore, binding of agrin to α -dystroglycan is inhibited by heparin (Bowe et al., 1994; Gee et al., 1994; Campanelli et al., 1994; Sugiyama et al., 1994). To test whether AChR aggregation induced by $c45_{A4B8}$ and $c21_{B8}$ could be inhibited by heparin, chick primary myotubes were incubated for 6 h with approximately four times the amount of recombinant agrin needed to induce half-maximal response. While AChR aggregation induced by $c45_{A4B8}$ was inhibited by heparin, no inhibition was observed for AChR aggregation induced by $c21_{B8}$ (Fig. 8 a). These results indicate that heparin does not inhibit AChR aggregation per se.

Since 100-fold higher concentrations of $c21_{B8}$ are needed to induce the same number of AChR clusters as for $c45_{A4B8}$, we tested the heparin-binding properties of $c45_{A4B8}$ and $c21_{B8}$. Conditioned medium of transfected COS cells was applied to heparin columns and the concentration of recombinant agrin in the flowthrough and the eluate was determined by immunoprecipitation. In agreement with the results on heparin-inhibition of AChR aggregation, $c45_{A4B8}$ bound to these columns and $c21_{B8}$ was detected in the flowthrough (Fig. 8 b). We also tested whether this treatment depleted AChR-aggregating activity of the conditioned medium. Indeed, no AChR-aggregating activity was detected

in $c45_{A4B8}$ -containing medium after heparin column chromatography, while activity in $c21_{B8}$ -containing medium was unchanged (data not shown). Thus, $c21_{B8}$ has lost the capability of binding heparin. Our results show that it nevertheless retains AChR-aggregating activity, indicating that the binding sites for heparin and for activating a signal-transducing receptor are distinct from each other. The 100-fold higher EC_{50} of $c21_{B8}$ suggests that the heparin-binding site in agrin may have an important auxiliary function in agrin-induced AChR aggregation.

Discussion

Role of Agrin Isoforms in the Formation of the Neuromuscular Junction

Our results show that $agrin_{A4B8}$ and $agrin_{A4B19}$ are most potent in inducing AChR aggregation. Early in the development of the chick, the most abundant agrin mRNA in cholinergic neurons, such as ciliary ganglia neurons and motor neurons, codes for $agrin_{A4B19}$ (McMahan et al., 1992; Smith and O'Dowd, 1994; Ruegg, M. A., M. J. Werle, S. E. Horton, L. S. Honig, and U. J. McMahan, manuscript in preparation). Later, chick motor neurons express high levels of $agrin_{A4B8}$ (Honig, L. S., D. Stone, K. Nikolics, and U. J. McMahan, 1993. *Soc. Neurosci. Abstr.* 1272) and its relative abundance increases in chick ciliary ganglia (Thomas et al., 1993) and rat spinal cord (Hoch et al., 1993). In addition,

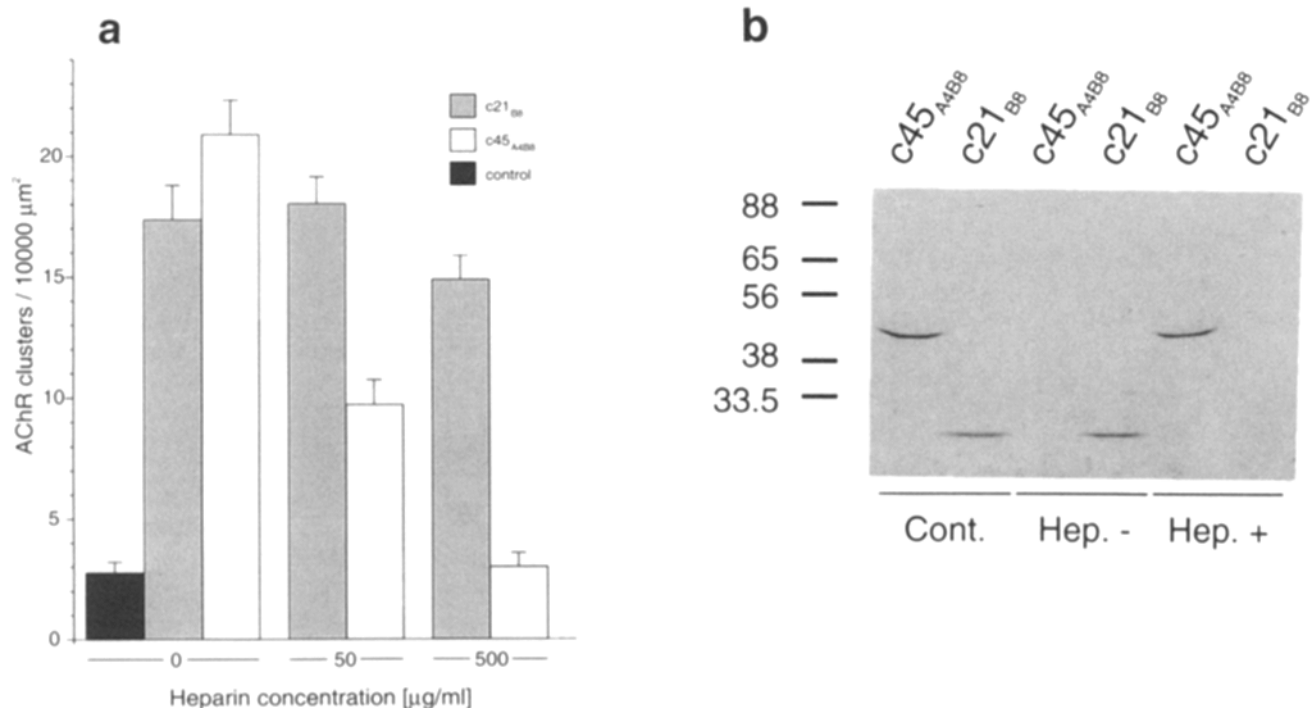

Figure 8. Inhibition of agrin-induced AChR aggregation by heparin and binding of agrin fragments to heparin columns. (a) 4 U (1 U = concentration of agrin inducing half-maximal response) of $c45_{A4B8}$ or $c21_{B8}$ were added to primary chick myotubes for 6 h in the presence of heparin at the indicated concentration. Data points represent mean \pm SEM of 10 myotube segments. Heparin inhibits AChR aggregation induced by $c45_{A4B8}$ ($p < 0.001$), but not by $c21_{B8}$ ($p > 0.05$). (b) Binding of agrin fragments to heparin columns. Conditioned medium of ^{35}S -labeled COS cells that had been transfected with agrin constructs indicated were applied to heparin columns. Autoradiograms of 3–12% SDS-polyacrylamide gels of immunoprecipitations with anti-agrin antiserum. Different sections are: conditioned medium (Cont.), flowthrough (Hep. -), and eluate of the heparin columns (Hep. +). Quantification of the incorporated radioactivity under each condition shows that all $c45_{A4B8}$ is depleted by heparin columns, while no $c21_{B8}$ is retained.

most agrin mRNA in the electric lobe of *Discopyge ommata*, which consists of glial cells and motor neurons innervating the electric organ, encodes agrin_{A4B8} (McMahan et al., 1992). Thus, it is feasible that cholinergic neurons early in development secrete high amounts of agrin_{A4B19}, while at later stages and throughout adulthood, they synthesize agrin_{A4B8}. Our results that both isoforms are highly active in inducing AChR aggregation support the hypothesis by McMahan (1990) that agrin released by motor neurons induces the formation of synapses in the target cell.

As previously shown (Ruegg et al., 1992), agrin_{A4B11} is active in inducing AChR aggregation. With the quantitative assay, we demonstrate here that its EC₅₀ is approximately two orders of magnitude higher than that of agrin_{A4B8} or agrin_{A4B19}. The expression of transcripts encoding agrin_{A4B11} in tissue containing cholinergic neurons, such as spinal cord and ciliary ganglia, peaks very early in neural development (Thomas et al., 1993; Hoch et al., 1993), before differentiation to neurons is complete. Precursor cells in the neural tube synthesize mainly agrin_{A0B0} and agrin_{A4B0} (McMahan et al., 1992). Thus, differentiation into neurons may alter the intrinsic splice machinery of the cell such that the 33 bp are inserted at the B-site giving rise to mRNA encoding agrin_{A4B11}. Subsequent modification of this path later in development may then include the 24-bp exon, leading to the expression of mRNA encoding agrin_{A4B19} and/or agrin_{A4B8}. Thus, alteration of the splicing pattern in differentiating neurons would result in agrin isoforms that are active in inducing postsynaptic structures and agrin_{A4B11} would be the first transient means to achieve this.

In contrast to neurons, muscle cells express high levels of transcripts encoding agrin_{A0B0} (Ruegg et al., 1992; Hoch et al., 1993; Ma et al., 1994). In agreement with previous reports (Ruegg et al., 1992), we find that recombinant agrin_{A0B0} does not show any activity. From this we conclude that agrin isoforms secreted by muscle cells do not play a primary role in clustering AChRs. This conclusion is strengthened by findings of Reist et al. (1992) that agrin released from motor neurons and not from myotubes induces the formation of AChR clusters in vitro. Our conclusion would also be in agreement with many other studies in several species showing that the formation of neurotransmitter-receptor clusters in vivo depends on innervation (e.g., Frank and Fischbach, 1979; Dahm and Landmesser, 1991; Liu and Westerfield, 1992; Broadie and Bates, 1993).

Differential Activities of Chick and Rat Agrin Isoforms

The ability of agrin isoforms to induce AChR clusters has also been tested using rat cDNA clones (Ferns et al., 1992, 1993). With COOH-terminal fragments of agrin_{A4B8}, agrin_{A4B0}, and agrin_{A0B0} that were 78 amino acids longer than chick c95-fragments, agrin_{A4B8} was ~1,000-fold more potent in inducing AChR clusters on C2 myotubes than agrin_{A4B0} and no activity was detected for agrin_{A0B0} (Ferns et al., 1993). Thus, AChR-aggregating activity of COOH-terminal fragments of rat and chick agrin isoforms is qualitatively similar although no direct comparison of their dose dependence (EC₅₀) is possible.

This dependence of AChR-aggregating activity on the composition of agrin at sites A and B is not seen under certain conditions (Ferns et al., 1992, 1993). COS cells that are transfected with full-length rat agrin expressed the protein on

their cell surface (Campanelli et al., 1991). When tested in this cell-attached form, AChR aggregation on rat primary and on C2 myotubes was induced by all agrin isoforms. On primary chick myotubes, only agrin_{A4B8} and agrin_{A4B19} were highly active, while agrin_{A4B11} was moderately active and agrin_{A4B0} was inactive (Ferns et al., 1992, 1993). In an attempt to find reasons for such behavior of rat agrin, we have determined dose response curves for full-length chick agrin and have tested some of the chick agrin isoforms on C2 myotubes. Our findings show that the correlation between AChR-aggregating activity and the composition of agrin at sites A and B is influenced by neither the size and the species (chick or ray) of agrin nor the origin of the myotubes (Fig. 5). Since we used soluble agrin in all of our assays, we conclude that the presentation of rat agrin on the surface of transfected cells is most likely the reason for the different results. It remains to be seen whether phosphorylation of the β subunit of AChRs observed after the addition of soluble agrin can also be triggered by high local concentrations of weakly active or inactive agrin isoforms.

Domains of Agrin Involved in AChR Aggregation

To obtain insights into the molecular mechanisms by which agrin induces AChR aggregation and to assess the role of structural domains of agrin in this process, we determined the EC₅₀ of deletion mutants of agrin to induce AChR clustering. Agrin fragments lacking the NH₂-terminal half, which contains domains that have been proposed to be of potential importance for agrin binding to basal lamina or to certain differentiation factors (discussed in Patthy and Nikolics, 1993), show the same dose dependence as full-length agrin_{A4B8} (Fig. 5 a). Thus, the 95-kD, COOH-terminal fragment comprises all of the structural domains that contribute to agrin's AChR-aggregating activity. Removing all the domains except those that contain sites A and B resulted in the fragment c45_{A4B8} with ~4 times higher EC₅₀ (Fig. 7). This indicates that either G1 and/or any of the three EGF-like repeats contribute to agrin's AChR-aggregating activity or that the folding of c45_{A4B8} is slightly altered. Deletion of G2, containing site A, and the last EGF-like repeat increased EC₅₀ by approximately two orders of magnitude (Fig. 7). Nevertheless, this recombinant fragment was capable of inducing AChR aggregation to the same extent as the other fragments, indicating that the presence of site B₈ together with G3 is sufficient for this activity. Our data on heparin binding of c21_{B8} and inhibition of AChR aggregation by heparin suggest that the higher EC₅₀ of c21_{B8} may be due to the loss of the heparin-binding site rather than to the misfolding of the recombinant fragment (see below). We further tested activity of a cyclic peptide with the sequence of B₈ and a linear B₈-peptide that was flanked by 11-amino acid long spacers. Both reagents neither induced nor inhibited AChR aggregation (data not shown), demonstrating that the B insert alone is not sufficient for activity. These results indicate that binding of agrin to its signal-transducing receptor depends on the secondary structure of the ligand. Consequently, we hypothesize that amino acids of insert B may impose a certain structure on the G3 domain to expose the actual receptor-binding site.

A similar approach to characterize the active site of rat agrin has been taken by Hoch et al. (1994). Their smallest fragment capable of inducing AChR aggregation was larger

than c45_{A4B8} and still contained the third EGF-like repeat. No activity was detected in a fragment similar in size to c45_{A4B8} that also included G2, the last EGF-like repeat and G3. In contrast to c45_{A4B8}, the rat fragment was poorly secreted from COS cells. According to Hoch et al. (1994), the amount of the small fragment secreted by COS cells is only ~1/100 of that of their 95-kD fragment. In our experiments, COS cells secrete ~20 times more of c45_{A4B8} than c95_{A4B8}. This ~2,000-fold difference in secretion between similar constructs in rat and chick raises the possibility that the small agrin fragment in rat may not be folded correctly and hence be degraded, which would explain the failure to detect activity. Similarly, no activity was detected for rat constructs that contained the last EGF-like repeat and the G3 domain. Because Hoch et al. (1994) did not provide data on the concentrations of agrin fragments that were tested in the AChR aggregation assay, it is impossible to assess whether their experimental conditions would have allowed detection of activity of fragments with high EC₅₀ values.

Possible Mechanisms of Agrin-induced AChR Aggregation

AChR aggregation induced by agrin isolated from the electric organ of *Torpedo californica* is inhibited by heparin and several other polyanions (Wallace, 1990). The main fragment of active agrin found in such extracts has a M_r of 95 kD. We show that a 45 kD, COOH-terminal fragment of agrin_{A4B8} still binds to heparin, indicating that domains G2, the fourth EGF-like repeat, and G3 are sufficient for this binding. Since the agrin fragment c21_{B8} has lost this heparin-binding site, domains G2 and/or the fourth EGF-like repeat are required for heparin-binding. In laminin, the heparin-binding site has been mapped to the elastase fragment E3, which consists of the last two G domains of the terminal globule of the α -chains (Ott et al., 1982; Skubitz et al., 1988, 1991). In analogy, we suggest that the G2 domain and not the fourth EGF-like repeat of agrin is required to bind heparin.

Heparin bound to agrin could either interfere with sites that are necessary for agrin to interact with its signal-transducing receptor, or prevent binding of agrin to molecules supporting its AChR-aggregating activity. Our finding that the EC₅₀ of c21_{B8} is ~100-fold higher than that of c45_{A4B8} suggests the latter possibility to be more likely. Since heparan sulfate also inhibits agrin- and nerve-induced AChR aggregation (Hirano and Kidokoro, 1989; Wallace, 1990), heparan sulfate proteoglycans that accumulate at both nerve- and agrin-induced AChR aggregates (Anderson and Fambrough, 1983; Wallace, 1989) are possible candidates for proteins that may bind agrin.

Another candidate is the recently identified α -dystroglycan, a peripheral membrane protein of the dystrophin-glycoprotein complex. A 100 kD, COOH-terminal fragment of rat agrin binds to α -dystroglycan with high affinity and its binding is inhibited by laminin and by low concentrations of heparin (Campanelli et al., 1994; Gee et al., 1994; Sugiyama et al., 1994). Likewise, laminin binding to α -dystroglycan is inhibited by heparin (Ervasti and Campbell, 1993). The α -dystroglycan-binding site in laminin has been mapped to fragment E3 and it has been suggested that domains responsible for binding to heparin and α -dystroglycan are identical (Gee et al., 1993). We show that in agrin the

G2 domain and/or the last EGF-like repeat are required for heparin-binding and we also propose that the binding sites for heparin and α -dystroglycan overlap.

The following observation supports this hypothesis. Agrin purified from electric organ of *Torpedo* consists of two major proteolytic fragments (M_r 95 kD and 70 kD) with identical NH₂-terminal sequences (Nitkin et al., 1987; Smith et al., 1992). The 70-kD fragment probably still contains domain G2, but lacks the last EGF-like repeat and G3. Confirming our results that G3 is required for AChR aggregation, the 70 kD fragment is inactive (Nitkin et al., 1987), but nevertheless it still binds to α -dystroglycan (Ma et al., 1993).

If c21_{B8} lacks the binding site to α -dystroglycan, the 100-fold higher EC₅₀ of this fragment compared to c45_{A4B8} suggests that α -dystroglycan serves as a helper protein to augment agrin's AChR-aggregating activity. Our data on the binding of heparin and its inhibitory effect on AChR aggregation indicate that the so far described binding of agrin to α -dystroglycan is not an absolute requisite for agrin to exert its AChR-aggregating activity. On the other hand, other components of the dystrophin-glycoprotein complex may serve as the signal-transducing receptor. Indeed, the findings that components of the dystrophin-glycoprotein complex are concentrated at agrin-induced AChR clusters in vitro (Campanelli et al., 1994; Gee et al., 1994; Sugiyama et al., 1994) as well as at the NMJ (Ohlendieck et al., 1991) suggest that they may contribute to the formation of postsynaptic structures. The possibility that α -dystroglycan may serve as helper protein for agrin's AChR-aggregating activity would fit well with findings for other differentiation factors, such as transforming growth factor- β (López-Casillas et al., 1991, 1993; Wang et al., 1991) and basic fibroblast growth factor (Rapraeger et al., 1991) where proteoglycans serve as cell surface receptors to present the ligands to their signaling receptors.

We thank B. Schumacher for excellent technical assistance, Dr. W. B. Adams for the help to set-up the computerized imaging system and for many fruitful discussions. We are grateful to Drs. H.-R. Brenner, A. Linstedt, and J. G. Nicholls for critically reading the manuscript.

This work was supported by a grant 31-33697.92 of the Swiss National Science Foundation.

Received for publication 26 August 1994 and in revised form 26 October 1994.

References

- Anderson, M. J., and D. M. Fambrough. 1983. Aggregates of acetylcholine receptors are associated with plaques of a basal lamina heparan sulfate proteoglycan on the surface of skeletal muscle cells. *J. Cell Biol.* 97:1396-1411.
- Blau, H. M., C.-P. Chiu, and C. Webster. 1983. Cytoplasmic activation of human nuclear genes in stable heterocaryons. *Cell.* 32:1171-1180.
- Bourdon, M. A., T. Krusius, S. Campbell, N. B. Schwartz, and E. Ruoslahti. 1987. Identification and synthesis of a recognition signal for the attachment of glycosaminoglycans to proteins. *Proc. Natl. Acad. Sci. USA.* 84:3194-3198.
- Bowe, M. A., K. A. Deyst, J. D. Leszyk, and J. R. Fallon. 1994. Identification and purification of an agrin receptor from *Torpedo* postsynaptic membranes: a heteromeric complex related to the dystroglycans. *Neuron.* 12:1173-1180.
- Broadie, K., and M. Bate. 1993. Innervation directs receptor synthesis and localization in *Drosophila* embryo synaptogenesis. *Nature (Lond.).* 361:350-353.
- Campanelli, J. T., W. Hoch, F. Rupp, T. Kreiner, and R. H. Scheller. 1991. Agrin mediates cell contact-induced acetylcholine receptor clustering. *Cell.* 67:909-916.
- Campanelli, J. T., S. L. Roberds, K. P. Campbell, and R. H. Scheller. 1994. A role for dystrophin-associated glycoproteins and utrophin in agrin-induced AChR clustering. *Cell.* 77:663-674.
- Cohen, M. W., and E. W. Godfrey. 1992. Early appearance of and neuronal

- contribution to agrin-like molecules at embryonic frog nerve-muscle synapses formed in culture. *J. Neurosci.* 12:2982-2992.
- Cullen, B. R. 1987. Use of eukaryotic expression technology in the functional analysis of cloned genes. *Methods Enzymol.* 152:684-704.
- Dahm, L. M., and L. T. Landmesser. 1991. The regulation of synaptogenesis during normal development and following activity blockade. *J. Neurosci.* 11:238-255.
- Ervasti, J. M., and K. P. Campbell. 1993. A role for the dystrophin-glycoprotein complex as a transmembrane linker between laminin and actin. *J. Cell Biol.* 122:809-823.
- Ferns, M., W. Hoch, J. T. Campanelli, F. Rupp, Z. W. Hall, and R. H. Scheller. 1992. RNA splicing regulates agrin-mediated acetylcholine receptor clustering activity on cultured myotubes. *Neuron.* 8:1079-1086.
- Ferns, M., J. T. Campanelli, W. Hoch, R. H. Scheller, and Z. W. Hall. 1993. The ability of agrin to cluster AChRs depends on alternative splicing and cell surface proteoglycans. *Neuron.* 11:491-502.
- Fischbach, G. D. 1972. Synapse formation between dissociated nerve and muscle cells in low density cultures. *Dev. Biol.* 28:407-419.
- Frank, E., and G. D. Fischbach. 1979. Early events in neuromuscular junction formation in vitro. Induction of acetylcholine receptor clusters in the post-synaptic membrane and morphology of newly formed nerve-muscle synapses. *J. Cell Biol.* 83:143-158.
- Gee, S., F. Blacher, P. Douville, P. Provost, P. Yurchenko, and S. Carbonetto. 1993. Laminin-binding protein 120 from brain is closely related to the dystrophin associated glycoprotein, dystroglycan, and binds with high affinity the major heparin binding domain of laminin. *J. Biol. Chem.* 268:14972-14980.
- Gee, S., F. Montaro, M. Lindebaum, and S. Carbonetto. 1994. The dystrophin associated glycoprotein, dystroglycan- α , is a functional agrin receptor. *Cell.* 77:675-686.
- Gluzman, Y. 1981. SV40-transformed simian cells support the replication of early SV40 mutants. *Cell.* 23:175-182.
- Godfrey, E. W., R. M. Nitkin, B. G. Wallace, L. L. Rubin, and U. J. McMahan. 1984. Components of *Torpedo* electric organ and muscle that cause aggregation of acetylcholine receptors on cultured muscle cells. *J. Cell Biol.* 99:615-627.
- Godfrey, E. W. 1991. Comparison of agrin-like proteins from the extracellular matrix of chicken kidney and muscle with neural agrin, a synapse organizing protein. *Exp. Cell Res.* 195:99-109.
- Gorman, C. M., D. R. Gies, and G. McCray. 1990. Transient production of proteins using an adenovirus transformed cell line. *DNA Protein Eng. Tech.* 2:3-10.
- Graham, F. L., J. Smiley, W. C. Russell, and R. Nairu. 1977. Characteristics of human cell line transformed by DNA from human adenovirus type 5. *J. Gen. Virol.* 36:59-77.
- Hagen, S. G., A. F. Michael, and R. J. Butkowski. 1993. Immunochemical and biochemical evidence for distinct basement membrane heparan sulfate proteoglycans. *J. Biol. Chem.* 268:7261-7269.
- Hirano, Y., and Y. Kidokoro. 1989. Heparin and heparan sulfate partially inhibit induction of acetylcholine receptors accumulation by nerve in *Xenopus* culture. *J. Neurosci.* 9:1555-1561.
- Hoch, W., M. Ferns, J. T. Campanelli, Z. W. Hall, and R. H. Scheller. 1993. Developmental regulation of highly active alternatively spliced forms of agrin. *Neuron.* 11:479-490.
- Hoch, W., J. T. Campanelli, S. Harrison, and R. H. Scheller. 1994. Structural domains of agrin required for clustering of nicotinic acetylcholine receptors. *EMBO (Eur. Mol. Biol. Organ.) J.* 13:2814-2821.
- Ibraghimov-Beskrovnyaya O., J. M. Ervasti, C. J. Leveille, C. A. Slaughter, S. W. Sernett, and K. P. Campbell. 1992. Primary structure of dystrophin-associated glycoproteins linking dystrophin to the extracellular matrix. *Nature (Lond.)* 355:696-702.
- Laemmli, U. K. 1970. Cleavage of structural proteins during the assembly of the head of bacteriophage T4. *Nature (Lond.)* 227:680-685.
- Liu, D. W. C., and M. Westerfield. 1992. Clustering of muscle acetylcholine receptors requires motoneurons in life embryos, but not in cell culture. *J. Neurosci.* 12:1859-1866.
- López-Casillas, F., S. Cheifetz, J. Doodey, J. L. Andres, W. S. Lane, and J. Massagué. 1991. Structure and expression of the membrane proteoglycan betaglycan, a component of the TGF- β receptor system. *Cell.* 67:785-795.
- López-Casillas, J. L. Wrana, and J. Massagué. 1993. Betaglycan presents ligand to the TGF- β signaling receptor. *Cell.* 73:1435-1444.
- Lowry, O. H., N. J. Rosebrough, A. L. Farr, and R. J. Randall. 1951. Protein measurement with the folin phenol reagent. *J. Biol. Chem.* 193:265-275.
- Ma, J. M., A. Nastuk, B. A. McKechnie, and J. R. Fallon. 1993. The agrin receptor: localization in the postsynaptic membrane, interaction with agrin, and relationship to the acetylcholine receptor. *J. Biol. Chem.* 268:25108-25117.
- Ma, E., R. Morgan, and E. W. Godfrey. 1994. Distribution of agrin mRNAs in the chick embryo nervous system. *J. Neurosci.* 14:2943-2952.
- Magill-Solc, C., and U. J. McMahan. 1988. Motor neurons contain agrin-like molecules. *J. Cell Biol.* 107:1825-1833.
- Magill-Solc, C., and U. J. McMahan. 1990. Synthesis and transport of agrin like molecules in motor neurons. *J. Exp. Biol.* 153:1-10.
- Matsumura, K., and K. P. Campbell. 1994. Dystrophin-glycoprotein complex: its role in the molecular pathogenesis of muscular dystrophies. *Muscle & Nerve.* 17:2-15.
- McMahan, U. J. 1990. The agrin hypothesis. In Cold Spring Harbor Symposium on Quantitative Biology. Vol. LV. Cold Spring Harbor Laboratory Press, Cold Spring Harbor, NY. 407-418.
- McMahan, U. J., S. E. Horton, M. J. Werle, S. L. Honig, S. Kröger, M. A. Ruegg, and G. Escher. 1992. Agrin isoforms and their role in synaptogenesis. *Curr. Opin. Cell Biol.* 4:869-874.
- Morrisey, J. H. 1981. Silver stains for proteins in polyacrylamide gels: a modified procedure with enhanced uniform sensitivity. *Anal. Biochem.* 117:307-310.
- Nastuk, M. A., E. Lieth, J. Ma, C. A. Cardasis, E. B. Moynihan, B. A. McKechnie, and J. R. Fallon. 1991. The putative agrin receptor binds ligands in a calcium-dependent manner and aggregates during agrin-induced acetylcholine receptor clustering. *Neuron.* 7:807-818.
- Nitkin, R. M., M. A. Smith, C. Magill, J. R. Fallon, Y.-M. M. Yao, B. G. Wallace, and U. J. McMahan. 1987. Identification of agrin, a synaptic organizing protein from *Torpedo* electric organ. *J. Cell Biol.* 105:2471-2478.
- Ohlendieck, K., J. M. Ervasti, K. Matsumura, S. D. Kahl, C. J. Leveille, and K. P. Campbell. 1991. Dystrophin-related protein is localized to neuromuscular junction of adult skeletal muscle. *Neuron.* 7:499-508.
- Ott, U., E. Odermatt, J. Engel, H. Furthmayr, and R. Timpl. 1982. Protease resistance and conformation of laminin. *Eur. J. Biochem.* 123:63-72.
- Pathy, L., and K. Nikolics. 1993. Function of agrin and agrin related proteins. *Trends Neurosci.* 16:76-81.
- Puck, T. T., S. J. Ciecura, and A. Robinson. 1958. Genetics of somatic mammalian cells. III. Long term cultivation of euploid cells from human and animal species. *J. Exp. Med.* 108:945-955.
- Rapraeger, A. C., A. Krufka, and B. B. Olwin. 1991. Requirement of heparan sulphate for bFGF-mediated fibroblast growth and myoblast differentiation. *Science (Wash. DC)* 252:1705-1707.
- Reist, N. E., C. Magill, and U. J. McMahan. 1987. Agrin-like molecules at synaptic sites in normal, denervated, and damaged skeletal muscles. *J. Cell Biol.* 105:2457-2469.
- Reist, N. E., M. J. Werle, and U. J. McMahan. 1992. Agrin released by motor neurons induces the aggregation of acetylcholine receptors at neuromuscular junctions. *Neuron.* 8:865-868.
- Ruegg, M. A., E. T. Stoeckli, T. B. Kuhn, M. Heller, R. Zuellig, and P. Sonderegger. 1989. Purification of axonin-1, a protein that is secreted from axons during neurogenesis. *EMBO (Eur. Mol. Biol. Organ.) J.* 8:55-63.
- Ruegg, M. A., K. W. K. Tsim, S. E. Horton, S. Kröger, G. Escher, E. M. Gensch, and U. J. McMahan. 1992. The agrin gene codes for a family of basal lamina proteins that differ in function and distribution. *Neuron.* 8:691-699.
- Rupp, F., D. G. Payan, C. Magill-Solc, D. M. Cowan, and R. H. Scheller. 1991. Structure and expression of a rat agrin. *Neuron.* 6:811-823.
- Rupp, F., T. H. Ozcelik, M. Linial, K. Peterson, U. Franke, and R. H. Scheller. 1992. Structure and chromosomal location of the mammalian agrin gene. *J. Neurosci.* 12:3535-3544.
- Sealock, R., and S. C. Froehner. 1994. Dystrophin-associated proteins and synapse formation: is α -dystroglycan the agrin receptor? *Cell.* 77:617-619.
- Skubitz, A. P. N., J. B. McCarthy, A. S. Charonis, and L. T. Furcht. 1988. Localization of three distinct heparin-binding domains of laminin by monoclonal antibodies. *J. Biol. Chem.* 263:4861-4868.
- Skubitz, A. P. N., P. C. Letourneau, E. Wayner, and L. T. Furcht. 1991. Synthetic peptides from the carboxy-terminal globular domain of the A chain of laminin: their ability to promote cell adhesion and neurite outgrowth, and interact with heparin and β 1 integrin subunit. *J. Cell Biol.* 115:1137-1148.
- Smith, M. A., and D. K. O'Dowd. 1994. Cell-specific regulation of agrin RNA splicing in the chick ciliary ganglion. *Neuron.* 12:795-804.
- Smith, M. A., C. Magill-Solc, F. Rupp, Y.-M. M. Yao, J. W. Schilling, I. Snow, and U. J. McMahan. 1992. Isolation and characterization of an agrin homologue in the marine ray. *Mol. Cell Neurosci.* 3:406-417.
- Sugiyama, J., D. C. Bowen, and Z. W. Hall. 1994. Dystroglycan binds nerve and muscle agrin. *Neuron.* 13:103-115.
- Thomas, W. S., D. K. O'Dowd, and M. A. Smith. 1993. Developmental expression and alternative splicing of chick agrin mRNA. *Dev. Biol.* 158:523-535.
- Tsim, K. W. K., M. A. Ruegg, G. Escher, S. Kröger, and U. J. McMahan. 1992. cDNA that encodes active agrin. *Neuron.* 8:677-689.
- Wallace, B. G. 1988. Regulation of agrin-induced acetylcholine receptor aggregation by Ca²⁺ and phorbol ester. *J. Cell Biol.* 107:267-278.
- Wallace, B. G. 1989. Agrin-induced specializations contain cytoplasmic, membrane, and extracellular matrix-associated components of the postsynaptic apparatus. *J. Neurosci.* 9:1294-1302.
- Wallace, B. G. 1990. Inhibition of agrin-induced acetylcholine receptor aggregation by heparin, heparan sulphate, and other polyanions. *J. Neurosci.* 10:3576-3582.
- Wallace, B. G. 1994. Staurosporine inhibits agrin-induced acetylcholine receptor phosphorylation and aggregation. *J. Cell Biol.* 125:661-668.
- Wallace, B. G., Z. Qu, and R. L. Haganir. 1991. Agrin induces phosphorylation of the nicotinic acetylcholine receptor. *Neuron.* 6:869-878.
- Wang, X.-F., H. Y. Lin, E. Ng-Eaton, J. Downward, H. F. Lodish, and R. A.-S. Weinberg. 1991. Expression cloning and characterization of the TGF- β type III receptor. *Cell.* 67:797-805.
- Yaffe, D., and O. Saxel. 1977. Serial passaging and differentiation of myogenic cells isolated from dystrophic mouse muscle. *Nature (Lond.)* 270:725-727.