

The discovery of SycO reveals a new function for Type Three Secretion Effector Chaperones

Inauguraldissertation

zur

Erlangung der Würde eines Doktors der Philosophie vorgelegt der
Philosophisch-Naturwissenschaftlichen Fakultät
der Universität Basel

von

Michel Letzelter

aus Frankreich

Basel, 2006



Genehmigt von der Philosophisch-Naturwissenschaftlichen Fakultät auf Antrag von :

Prof. Dr. G. R. Cornelis

Prof. Dr. C. Dehio

Prof. Dr. U. Jenal

Basel, den 19.12.2006

Prof. Dr. H-P Hauri, Dekan.

Abstract :

The Type Three Secretion (T3S) system is a device used by many Gram-negative pathogens that allows bacteria to deliver effector proteins straight into the eukaryotic cell cytosol. These effectors interfere with various signaling pathways to subvert the host cell functions. The secretion machinery of the T3S system consist of a basal body spanning the bacterial inner and outer membrane followed by a stiff hollow needle outside the bacterium. The fully assembled secretion apparatus constitute a continuous hollow conduit that connects the bacteria to the eukaryotic target cell. After cell contact, virulence proteins -called effectors- are injected directly into the cytosol of the host cell via the T3S apparatus. Several effectors of the T3S system require the assistance of specific cytosolic chaperones to be efficiently exported. There are three classes of T3S chaperones. Effector proteins are assisted by Class I chaperones. Although Class I chaperones are well characterized, their main function is still a matter of controversy.

In this thesis, we demonstrate that *orf155* encodes a specific chaperone for the effector YopO that we called SycO. We showed that SycO enhances YopO secretion *in vitro* and is required for translocation of YopO into infected cells. By pulldown assay we demonstrated that residues 20 to 77 of YopO are required and sufficient for SycO binding. Using crosslinking experiments and size exclusion chromatography analysis, we determined the stoichiometry of purified SycO and YopO-SycO complexes. SycO alone forms dimers in solution and the YopO-SycO complex has a 1:2 stoichiometry. These results suggested that SycO is a typical chaperone of the Class I.

YopO is a serine/threonine kinase that interacts with Rho and Rac and disrupts the cytoskeleton of the target cells. YopO has been shown to localize at the cell plasma-membrane. By transfection of YopO-EGFP hybrid proteins into HEK293T cells, we demonstrated that the chaperone-binding domain (CBD) coincides with the membrane localization domain of YopO. Nevertheless, the CBD was not needed for the kinase activity of YopO. By ultracentrifugation, we also showed that the CBD causes YopO aggregation in the bacteria, when SycO does not cover it. Further, we show that the CBD of YopE and YopT also caused aggregation in the bacteria in the absence of SycE and SycT respectively. YopE, YopT and T3S effectors in other systems also act at the membrane of the eukaryotic host cell.

We propose a new hypothesis concerning the role of T3S chaperones. The sub-cellular localization domain of effectors is aggregation-prone and creates the need for a chaperone inside bacteria. We propose that masking such aggregation-prone localization domains may be a general function for type III effector chaperones.

Table of contents:

<u>Table of contents:</u>	1
I. Introduction	2
The type III secretion system :	3
Chaperonins and other chaperones:	6
Heat shock proteins (or chaperonins):	7
The SecB chaperone:	8
The periplasmic chaperone PapD:.....	10
Discovery of the T3S chaperones:	12
Characterization of T3S chaperones:	14
Classes of T3S chaperones:	14
Common traits of T3S chaperones:	14
Genetical environment of T3S chaperones:	14
Structure of T3S chaperones and complexes :	16
<i>Class I chaperones : Chaperones of the effectors</i>	16
<i>Class II chaperones : Chaperones of the translocators</i>	18
<i>Class III chaperones : Chaperones of the T3S apparatus subunits</i>	20
About chaperone classes.....	22
Multiple functions of T3S chaperones:	24
Class I : Chaperones of the effectors.....	25
Class II : Chaperones of the translocators.....	30
Class III : Chaperones of the T3S apparatus subunits.....	33
Final word:.....	34
II. Aim of the Thesis	35
III. Research Summary	37
IV. Results	39
V. Supplementary Material	41
<i>In silico</i> study of SycO:	42
Stoichiometry analysis of the YopO-SycO complex by crosslinking:	44
<i>In silico</i> study of YopO and YopE chaperone binding domain:.....	46
Protein purification and analysis:.....	47
VI. Unpublished Results	52
Stoichiometry analysis of the YopO-SycO complex by analytical size exclusion chromatography:	53
<i>In vitro</i> binding and solubilization of YopO by SycO:	54
Deletion of <i>sycO</i> by allelic exchange :	56
Analysis of the <i>sycO</i> mutant phenotype by <i>in vitro</i> secretion:	57
Secretion of Yop -Cya hybrid proteins:	57
Stability of YopO _{flag} and YopO _{20-77 flag} in Yersinia MRS40 and <i>sycO</i> :	60
Cellular localization of YopP-EGFP and YopN-EGFP:	61
YopT ₁₂₄ -EGFP kinetic of expression after transfection:	61
Intrabacterial solubility of YopH in the presence or in the absence of SycH:.....	64
VII. General Discussion and Conclusions	65
VIII. Outlooks	72
IX. References	74
X. Acknowledgments:	83

I. Introduction

The type III secretion system :

Bacterial interactions and cross-talk with animals or plants occurs in many different ways. The bacterial-host relation can be symbiotic, commensal or pathogenic. This communication is often mediated by bacterial secreted proteins acting on specific host cell targets. The outcome is the modification of the host cell behavior and response regarding the bacterial presence.

One of the devices developed by Gram-negative bacteria to communicate with the eukaryotic host cells is the type three secretion (T3S) system. Since the discovery of this secretion pathway in the 1990's, the recent sequencing of many bacterial genome revealed T3S to be vastly distributed in Gram-negative bacteria (Fig. 1). T3S systems are genetically encoded on genomic (pathogenicity) islands or on virulence plasmids acquired by horizontal transfer. These investigations also showed that this system is broadly involved in pathogenic relationships (Fig. 1) (Troisfontaines and Cornelis, 2005); (Mota *et al.*, 2005).

The secretion machinery of the T3S system called injectisome (or needle complex), is related to the bacterial flagellum. As they share many structural similarities, they are thought to have evolved from a common ancestor (Gophna *et al.*, 2003). The secretion apparatus consist of a basal body: two rings, spanning the bacterial inner and outer membrane, linked by a rod. From this membrane embedded structure protrudes a stiff hollow needle outside the bacterium (Fig. 2). In *Yersinia*, needles are tipped by a protein called LcrV which serves the assembly of a translocation pore in the eukaryotic cell membrane (Mueller *et al.*, 2005). The fully assembled injectisome constitute a continuous hollow conduit connecting the bacteria to the eukaryotic cell. After cell contact, the T3S apparatus injects virulence proteins, called effectors, directly into the cytosol of the host cell. Effectors are translocated in one step, from the bacterial cytosol across the inner membrane, the periplasm, the outer membrane, the lipopolysaccharide layer and the eukaryotic cell membrane (Fig. 3). Inside the eukaryotic cell the effectors manipulate the host cell response to the advantage of the bacterial pathogen, or of both organisms for symbionts. In animals, the activity of some effectors allows bacteria to invade non-phagocytic cells, others interfere with different signaling pathways, disturb the cytoskeleton dynamics, modify the pro-inflammatory response, induce apoptosis, or modulate intracellular trafficking. The set of translocated effectors varies between bacteria, according to their life style (symbiont or pathogen, intra- or extra-cellular) and their host. In *Yersinia*, six effectors are injected into the target cell. YopE, YopO, YopT are targeting small Rho-GTPases, disturbing cytoskeleton dynamics. YopH disrupts focal adhesions. YopP/YopJ counteracts the pro-inflammatory response and induces apoptosis in macrophages. Finally YopM appears to be translocated into the nucleus of the infected cells, but its function remains unclear (Mota and Cornelis, 2005).

Effectors travel unfolded through the injectisome, from the bacterium straight into the eukaryotic host cell cytosol (Blocker *et al.*, 2001) ; (Feldman *et al.*, 2002). The whole translocation process

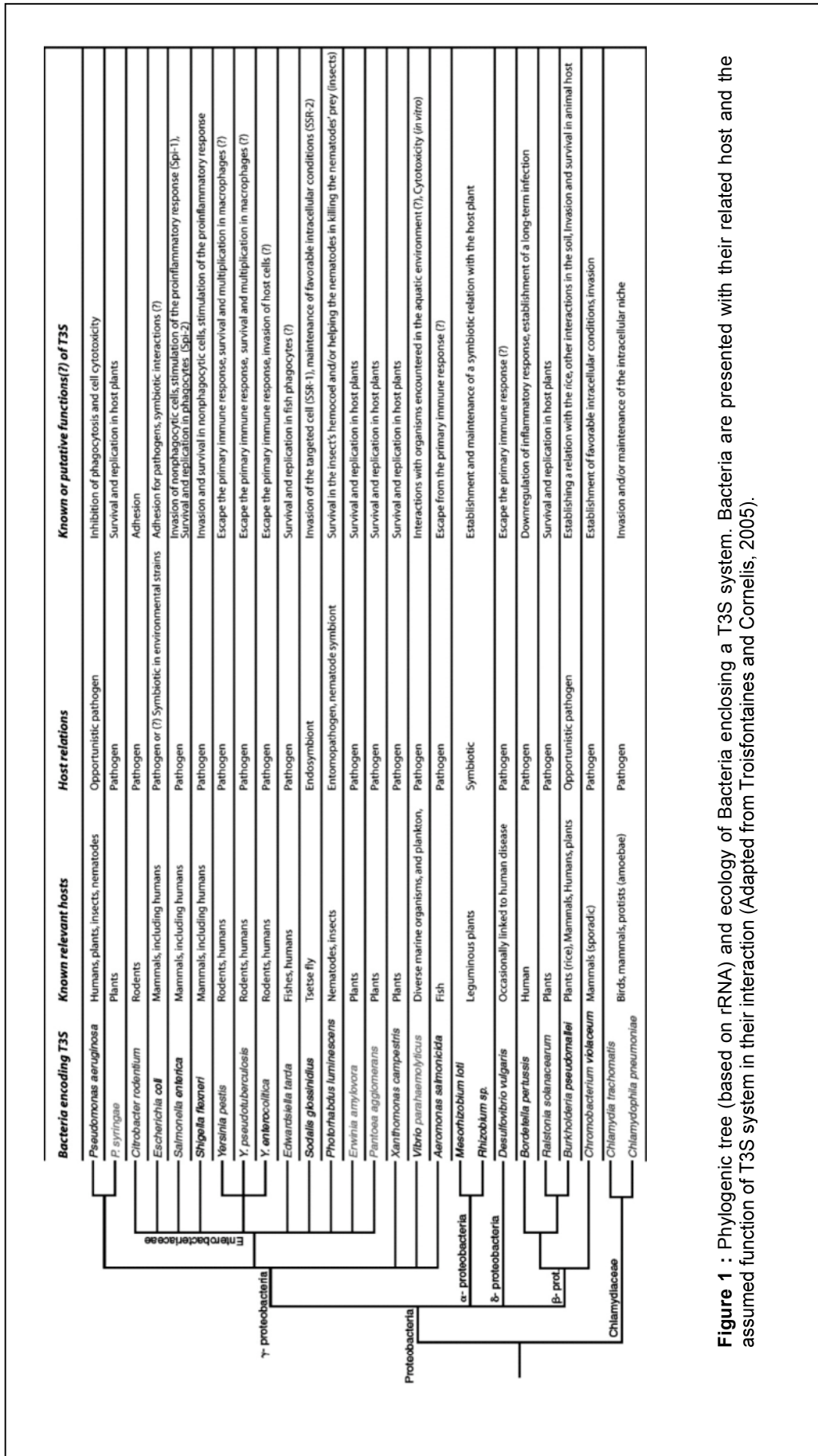

Figure 1 : Phylogenetic tree (based on rRNA) and ecology of Bacteria enclosing a T3S system. Bacteria are presented with their related host and the assumed function of T3S system in their interaction (Adapted from Troisfontaines and Cornelis, 2005).

is energized by an ATPase (YscN) present at the entrance of the channel, in the basal body (Woestyn *et al.*, 1994); (Muller *et al.*, 2006). The recognition of the T3S effectors is mediated by a N-terminal signal sequence present in the first 15 residues of the proteins (Sory *et al.*, 1995); (Lloyd *et al.*, 2001). In order to be operational in the assembly and fit for the export process, some of the T3S substrates require the assistance of small, specific proteins called T3S chaperones.

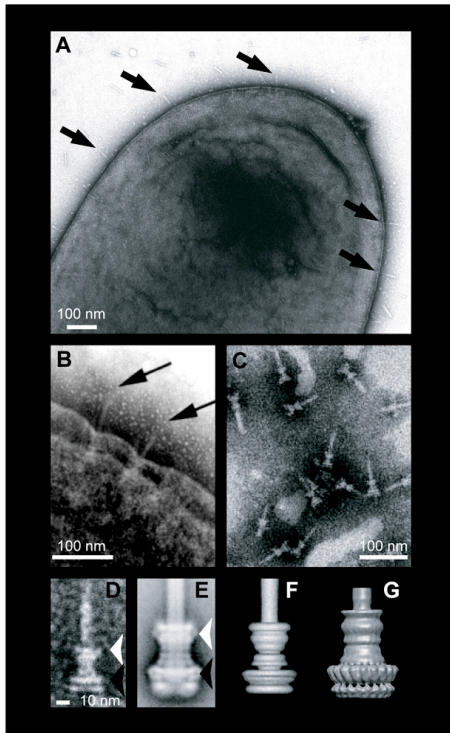

Figure 2 : Structure of the T3S apparatus :

T3S needles protrude at the surface of the bacteria (Black arrows, Fig. 2A and 2B). Needle complexes can be extracted from the bacteria and isolated. Electronic microscopy analysis of these complexes allowed structural determination of the core of the basal body, constituted of an outer ring (white arrow) and a inner ring (black arrow) (Fig. 2D, 2E). The three last pictures (Fig. 2E, 2F and 2G) are generated by averaging isolated needle complexes (e.g: Fig 2D). Radial symmetry can be implemented leading to Fig. 2G. (Journet and Cornelis *unpublished*; (Kubori *et al.*, 1998); (Tamano *et al.*, 2000); (Blocker *et al.*, 2001) ; (Marlovits *et al.*, 2004)).

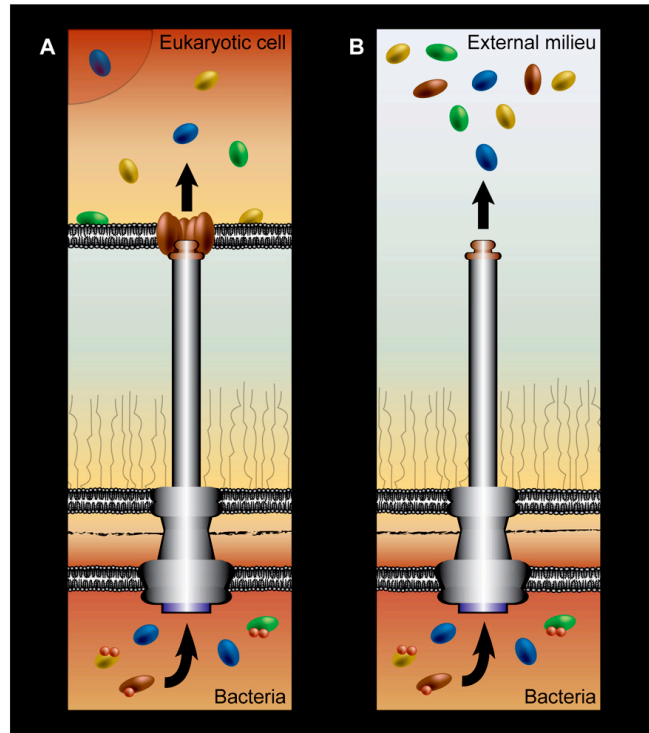

Figure 3: the Type three secretion system :

In vivo, the T3S system allows translocation of effector proteins in one step into the eukaryotic cell from the bacterial cytosol (Fig. 3A). The T3S apparatus (*in gray*) spans the two bacterial membranes and connects the host cell via a pore complex (*in brown*) inserted in the eukaryotic plasma membrane. Effector proteins (*in blue, yellow, or green*) can be injected directly into the eukaryotic cytosol. Translocation is triggered by contact with the host cell. This stimulus can be artificially substituted *in vitro* (e.g. Low calcium concentration in *Yersinia*, Congo Red in *Shigella*, high salt concentration in *Salmonella*). Effectors, translocators and some apparatus subunits are then released in the external milieu (Fig 3B). Some substrates of the T3S require the assistance of T3S chaperones (in red) to be exported.

Chaperonins and other chaperones:

The common definition of a chaperone is an adult person who accompanies one or more young, unmarried individuals during social occasions, in order to prevent inappropriate social interactions or illegal behavior. Even though the biological definition of chaperones applies to proteins, the concept is identical : Chaperones are proteins interacting transiently with one or several substrate, in order to prevent incorrect or premature intra- or inter-molecular interactions. Chaperones are not involved in the final function of their substrate.

The concept of chaperone appeared with the discovery and the characterization of the “heat shock proteins” (Hsp) by: Horwich AL, Neupert W and Hartl FU. In prokaryotes like *E. coli*, many of these proteins are highly expressed under stress conditions, for example high temperature. For this reason, the term “heat shock protein” has been used for many of them. According to their guiding role regarding protein folding and protein-protein interactions, they were called chaperones (or chaperonins). Chaperones associate with newly synthesized proteins that cannot fold by themselves (Fig. 4). There are many different families of chaperones in prokaryotes and in eukaryotes. Each family acts to aid protein folding in a different way.

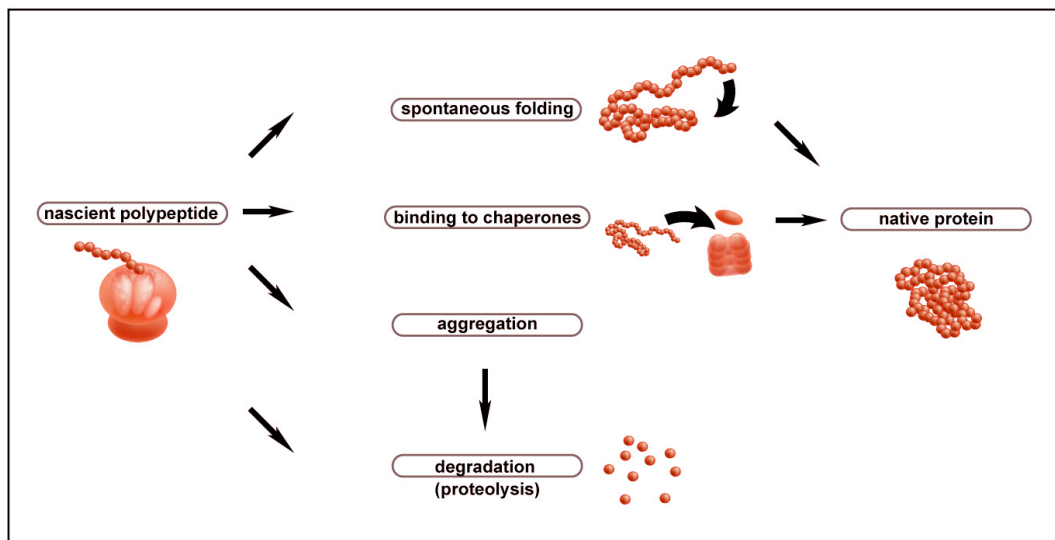

Figure 4 : General outline of protein folding into a cell :

A newly synthesized protein, still associated with ribosome or already released, faces several competing pathways. To achieve proper folding, they can undergo spontaneous folding, or associate with chaperones. It is likely that in the absence of chaperones, aggregation or other forms of misfolding would be the major pathways for many proteins.

Heat shock proteins (or chaperonins):

Hsp60 (called GroEL/GroES complex in *E. coli*) is the best characterized large (~ 1 MDa) chaperone complex (Fig. 5A). GroEL is a double 14mer ring, with a hydrophobic patch at each two openings. GroES is a single-ring heptamer that binds to GroEL. GroEL/GroES may not be able to undo previous aggregation, but it does compete against other proteins in the pathway of misfolding and aggregation. Non-folded polypeptide is accepted within one of the GroEL complex chamber and associates to the cavity walls via hydrophobic interactions (Figure 5B). The cavity is so large that it can accommodate a native folded GFP of 54-kDa in its lumen. GroES caps this structure triggering conformational changes that dislocate the hydrophobic surface away from the cavity walls and release the polypeptide into the sequestered space, triggering folding. This phase is ended by ATP hydrolysis; the affinity of GroEL for GroES is weakened preparing the complex for the release of the folded polypeptide. The entrance of a polypeptide in the opposite chamber triggers allosteric changes. These cause the dissociation of GroES from GroEL and the release of the substrate into solution (Fenton and Horwich, 2003). Hsp70 (DnaK in *E. coli*) is perhaps the best characterized small (~ 70 kDa) chaperonin. The Hsp70 proteins are helped by Hsp40 proteins (DnaJ in *E. coli*), which increase the ATP consumption rate and activity of the Hsp70s. Increased expression of Hsp70 proteins in a cell results in a decreased tendency towards apoptosis. Although a precise mechanism has yet to be determined, it is known that Hsp70's have a high-affinity for unfolded proteins when bound to ADP, and a low-affinity when bound to ATP. It is thought that many Hsp70s crowd around an unfolded substrate, stabilizing it and preventing its aggregation until it is properly folded. Then the Hsp70s lose affinity and diffuse away (Mayer and Bukau, 2005).

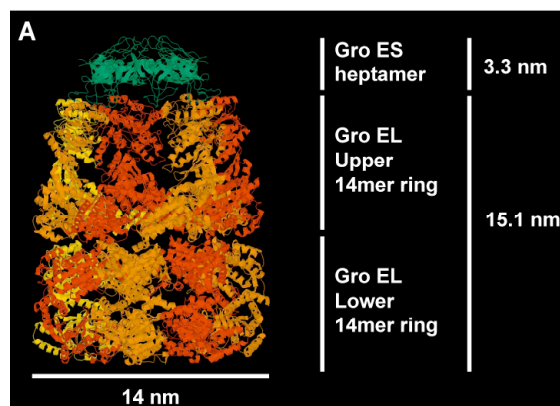

Figure 5A : GroEL structure. GroEL is a large double 14mer ring (Fig. 5A). Subunits are colored in red, orange or yellow (the four subunits at the back of the view are not visible). A GroES heptamer (in green) closes the GroEL cavity, capping the top of the complex.

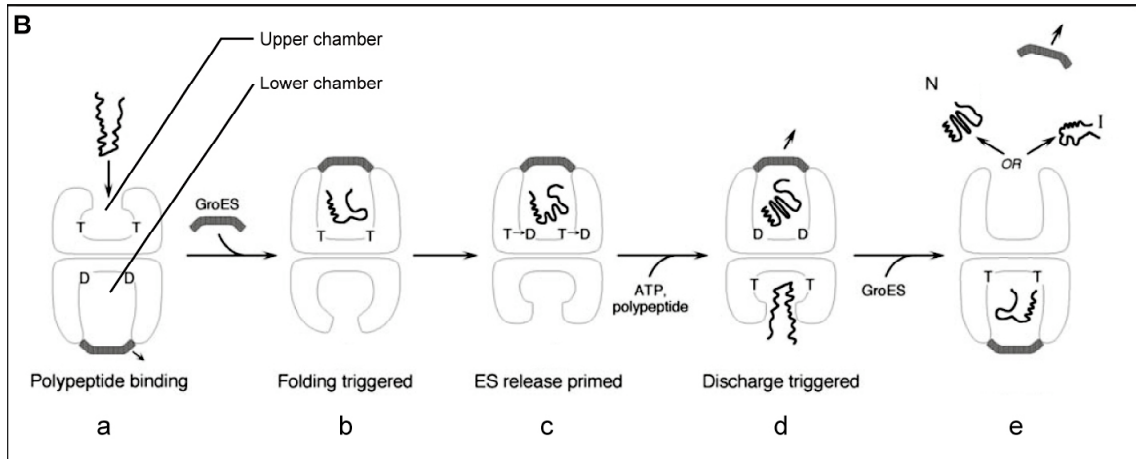

Figure 5B : The GroEL–GroES reaction pathway. (a) A non-native polypeptide (*solid wavy line*) binds to an asymmetric GroEL–GroES complex, the most likely acceptor state *in vivo*. It associates with the cavity walls of the open upper chamber, specifically with exposed hydrophobic side-chains of the apical domains. (b) GroES (*in shaded gray*) binds to the same ring as the non-native polypeptide, in the presence of ATP. Then, conformational changes liberate the polypeptide into the sequestered space, triggering folding. Folding proceeds in the upper chamber. This phase is ended by ATP hydrolysis (c). The affinity of GroEL for GroES is weakened preparing the upper ring complex for the release of its ligands. (d) When ATP and another non-native polypeptide molecule bind into the lower chamber, allosterical changes trigger dissociation of the ligands from the opposite (upper) chamber, discharging the substrate into solution. (e) The released substrate either has reached the native state (N) or one committed to it (Ic) or is still in a non-native state (I) that can bind to another GroEL molecule for a further attempt at folding.

The SecB chaperone:

The SecB chaperone is a small (17 kDa) cytosolic protein of the Sec pathway. In Gram-negative bacteria, periplasmic and outer membrane proteins are synthesized in the cytosol as precursor proteins (preproteins) that contain a N-terminal signal sequence. The Sec pathway translocates these preproteins across the cytoplasmic membrane (Fig. 6B) (Driessen, 2001). Once a major portion of the nascent preprotein has emerged from the ribosome (~150 aa), it is recognized by SecB homotetramers (Fig. 6A). The nascent polypeptide associates through hydrophobic and electrostatic interactions within a deep cleft at the surface of the chaperone multimer. In this way, SecB maintains the preprotein in a translocation-competent state, by preventing intra- or intermolecular interactions of the chaperone-covered domains. The complex is targeted to SecA, the peripheral ATPase subunit of the translocase. SecA initiates the translocation of the preprotein through the SecYEG translocon and SecB is then released.

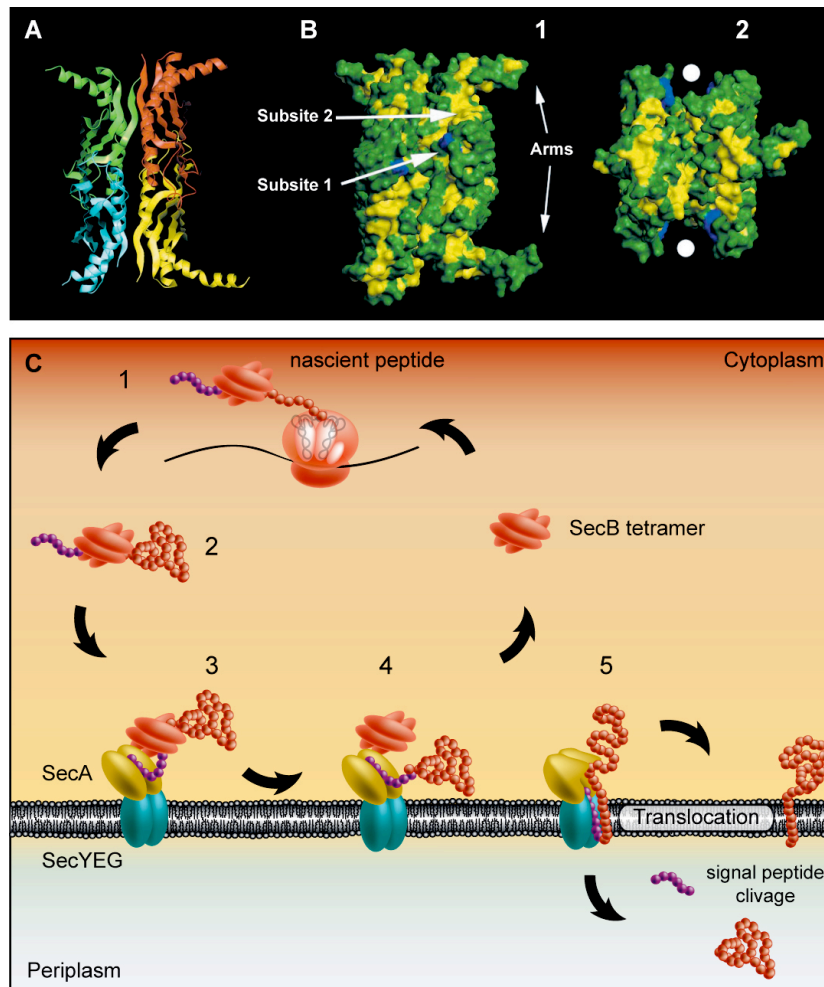

Figure 6 : The SecB chaperone, structure and mechanism :

A. Ribbon drawing of the SecB tetramer (based on the coordinates deposited to the Protein Data Bank as 1FX3). Each subunit in the tetramer is shown in a different color (1).

B. The proposed peptide-binding sites on SecB (according to Xu, Z. *et al.*, 2000). The solvent-accessible surface of SecB is colored based on the polarity of the underlying amino acids: all non-charged polar and charged side-chains, green; all hydrophobic side chains (except tryptophan), yellow; all backbone atoms, white. The conserved tryptophan residue is shown in blue. The drawing in (2) is the same orientation as in (1) and is rotated by 90° towards the horizontal axis to show the peptide-binding channels on each side of the tetramer. The channels are indicated with a white dot.

C. A possible mechanism of SecB-mediated targeting of preproteins to the translocase (adapted from Driessen, A.J. 2000). Cytosolic SecB binds targeting to the mature domain of a nascent preprotein (1), and stabilizes its unfolded state (2). The SecB–preprotein complex is targeted to the SecYEG-bound SecA (3). Targeting requires the high-affinity binding of SecB to the carboxyl terminus of SecA. Binding of the signal sequence to SecA tightens the SecB–SecA interaction and elicits the release of the preprotein from SecB-bound state with the concomitant transfer to SecA (4). Upon the binding of ATP by SecA, the preprotein translocation is initiated and SecB is released from the ternary complex (5).

The periplasmic chaperone PapD:

PapD is a 28.5kDa protein involved in the P pilus (Type 1 pilus) biogenesis. P pili are members of a large family of surface organelles involved in bacterial adhesion (Sauer *et al.*, 2000). P pili are composed of six structural proteins that interact to form a composite fiber with two subassemblies: a pilus rod formed by PapA subunits, and a thin fibrillum comprised primarily of PapE subunits arranged in an open helical configuration. The pilus subunits are synthesized in the cytoplasm of the bacteria and exported into the periplasm through the Sec pathway. There the nascent subunits associate with the PapD chaperone in stable complexes by donor strand complementation (Fig. 7A). The chaperone remains bound to the folded subunit, stabilizing and capping its interactive surfaces, preventing premature polymerization, or aggregation in the periplasm. Chaperone-subunit complexes are specifically targeted to the usher (Fig. 7B).

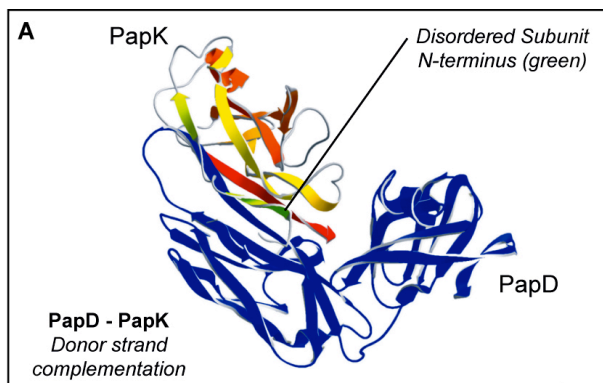

Figure 7A : Structure of the PapD chaperone in complex with PapK.

The chaperone PapD (in blue) binds other pilus subunits (here PapK in rainbow colors) by donor strand complementation. The chaperone completes the Ig fold of the subunit by giving its G1 strand. This interaction allows subunit folding and prevents subunits aggregation and premature polymerization.

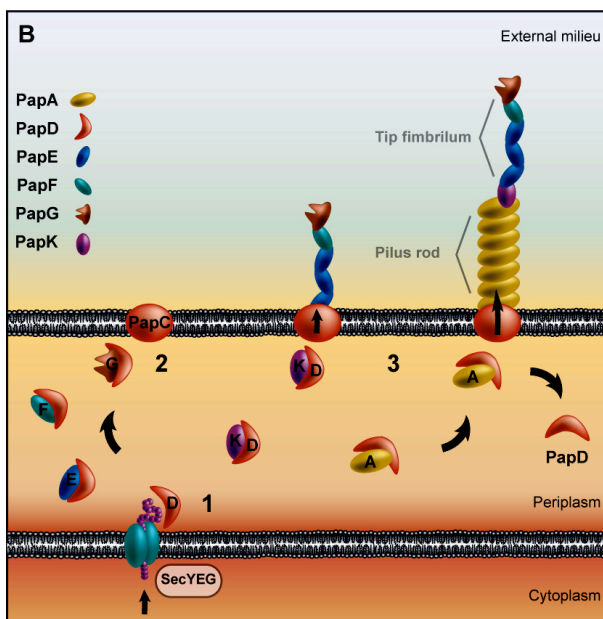

Figure 7B : The PapD chaperone and the P pilus biogenesis.

The Pap subunits of the pilus are translocated into the periplasm via the Sec pathway. The PapD chaperone associate with the nascent subunits in the periplasm (1). The chaperone-subunit complexes are then targeted to the outer membrane pore called the usher (PapC) (2). There, the N-terminus of an incoming subunit displaces the G1 strand of the chaperone in the most recently assembled chaperone subunit complex at the usher gate, leading to polymerization (3). The chaperone-adhesin complex (PapD-PapG) has a higher affinity to the usher, initiating the pilus assembly.

The usher is composed of PapC subunits and forms an outer membrane protein pore large enough to allow the passage of pilus subunits. In the *fim* and *pap* systems, it has been shown that the chaperone-adhesin complex binds with a higher affinity to the usher. This process is thought set a hierarchy to initiate the pilus assembly. Formation of a chaperone-adhesin-usher ternary complex induces a conformational change in the usher to an assembly-competent form that is maintained throughout pilus assembly. The usher facilitates chaperone uncapping to expose the interactive surfaces on the subunits that drive their assembly into the pilus.

Discovery of the T3S chaperones:

In the early days of the T3S characterisation, Forsberg A. and Wolf-Watz H. identified a small open reading frame (orf) upstream from the effector gene *yopE*. This orf, conserved in all three pathogenic *Yersinia* species (*Y.pestis*, *Y.pseudotuberculosis* and *Y.enterocolitica*), encoded a small protein of 130 amino acids. Insertion mutants were generated to knock out this gene. They were tested for their ability to secrete proteins in the external milieu (*in vitro* type three secretion in absence of calcium) and their virulence in mouse was evaluated. YopE was secreted to a lower extent in the insertion mutant than in the wild type. As well, the virulence in mouse was abolished (Forsberg and Wolf-Watz, 1990). As the secretion of the YopE protein by the mutant bacteria was decreased, the authors concluded that the gene encoded upstream *yopE* could encode a regulator. They subsequently called this gene: *yerA*, for *yopE* regulating gene A.

In 1993, Wattiau and Cornelis studied the counterpart of *yerA* in *Y.enterocolitica* : *sycE*. They demonstrated that if SycE has an influence on the production of YopE, it was at the post-transcriptional level. Indeed using a *yopE-lacZ* reporter gene assay, the authors showed that the level of *yopE* transcription was not affected when *sycE* was mutated (Wattiau and Cornelis, 1993). Apparently the lack of SycE affected more the secretion of YopE than its production in the cell. By overlay, they demonstrated the direct binding of the SycE protein to YopE in a specific manner. With these observations, the authors raised a new concept in the T3S. Accordingly, by binding YopE, SycE could help to target the complex to the secretion apparatus, prevent YopE folding and protect YopE from aggregation or proteolytic degradation. This strongly reminds the function of more general chaperones like SecB or PapD. The authors subsequently named the protein SycE for Specific YopE chaperone instead of YerA.

In addition to the new concept, this work also revealed some characteristics of the T3S effector chaperone. The authors determined that SycE is cytosolic and that it binds to the N-terminal part (98 first amino acids) of the effector. They also determined the apparent molecular mass of purified SycE by size exclusion chromatography: slightly above 30 kDa, suggesting a dimeric organization.

As the influence of SycE is limited to YopE, some other specific chaperones should have been found for other secreted Yop proteins. Indeed, these first assumptions, and the notion of T3S chaperone were reinforced in 1994 by the following discovery and the study of similar proteins. Wattiau *et al.* presented the characterization of SycH and SycD playing an identical role with YopH, and YopB and D (Wattiau *et al.*, 1994).

Meanwhile, Ménard *et al.* revealed the existence of an equivalent protein in *Shigella*. IpgC a small protein of 17kDa is required for bacterial entry into epithelial cells. Further investigations showed that IpgC could bind independently to the translocators IpaB or IpaC. IpgC was required

to stabilize IpaB and to prevent proteolytic degradation of IpaC (Menard *et al.*, 1994). The functional analogy between these T3S proteins and other chaperones was then well established.

On this background started the intensive study of the T3S chaperones. Nowadays, even though their structure and the way they interact with their substrate are well characterized, the main function of T3S chaperones remains a matter of controversy.

Characterization of T3S chaperones:

Classes of T3S chaperones:

According to the nature of the substrate they bind, chaperones have been sorted in three major classes (Parsot *et al.*, 2003). Class I chaperones are committed to one (Class IA) or more (Class IB) effectors proteins. Class II chaperones are dedicated to the translocators and Class III chaperones to the apparatus subunits of the T3S (Table 1). The organization in three classes based on chaperones substrate may appear arbitrary. However, as presented in this chapter, recent structural data show that the different chaperone classes correlates with different chaperone structures.

Common traits of T3S chaperones:

Even though their primary sequence is not conserved, T3S chaperones share a number of characteristic properties. They have a small size; their MW is ranging from 14 to 19 kDa. They have an acidic pI, between 4 and 5 (with few exceptions). T3S chaperones are cytosolic proteins; they are not exported. Except a few exceptions in the Class IB all T3S chaperones have substrate specificity (one or two substrates only). Class I chaperones arrange in dimers and present a typical C-terminal amphipathic α -helix.

Genetical environment of T3S chaperones:

T3S chaperones genes are generally included in the set of virulence genes on pathogenicity islands, or virulence plasmids. Usually, they are encoded adjacently to their cognate effector gene, however this is not an absolute rule. One could imagine that the close co-expression could be important in the process of binding between the two partners, and for the protective role of the chaperone. But, some chaperone genes are located far away from the gene encoding their substrate. In *Y.pseudotuberculosis*, the consequence of an inversion event brought *sycH* ~20kb away from *yopH* on the 70kb virulence plasmid. In addition more recent studies revealed that some of the T3S chaperones are able to bind and assist two or more different substrates (e.g. Spa15) (Page *et al.*, 2002), sometimes not even encoded on the same pathogenicity island (e.g. InvB) (Ehrbar *et al.*, 2003).

Table 1 : Representative T3S Chaperones of the different classes:

Class IA :						
Organism	Chaperone	Size (aa)	pI	Substrate	Crystal structure	Membrane localization of the Effector
<i>EPEC</i>	CesF	127	4.2	EspF	No	(Mitochondrial)
<i>Salmonella</i>	SicP(SPI-I)	116	3.9	SptP	Yes (in complex)	Yes
<i>Salmonella</i>	SigE(SPI-I)	113	3.9	SopB (SigD)	Yes	Yes
<i>Salmonella</i>	SscB (SPI-II)	144	5.1	SseF	No	Yes
<i>Shigella</i>	IpgE	120	4.0	IpgD	No	Not shown
<i>Shigella</i>	IpgA	129	4.8	IcsB	No	Not shown
<i>Yersinia</i>	SycE	130	4.5	YopE	Yes (in complex)	Yes
<i>Yersinia</i>	SycH	143	4.8	YopH	Yes (in complex)	(Focal adhesion)
<i>Yersinia</i>	SycN	123	5.1	YopN	Yes (in complex)	Not shown
<i>Yersinia</i>	SycO	155	4.7	YopO	No	Yes
<i>Yersinia</i>	SycT	130	4.4	YopT	Yes	Yes
<i>Yersinia</i>	YscB	137	9.3	YopN	Yes (in complex)	Not shown
Class IB :						
<i>EPEC</i>	CesT	156	4.3	Tir, Map	Yes	Yes (Tir), Mitochondrial membrane (Map)
<i>Salmonella</i>	InvB	135	4.4	SopA, SopE, SopE2, SipA (SspA)	Yes (SipA complex)	Yes (SopE, SopE2, SipA)
<i>Shigella</i>	Spa15	133	4.2	IpaA, IpgB1, OspC3, OspB	Yes	Yes (IpaA)
Class II :						
Organism	Chaperone	Size (aa)	pI	Substrate	Crystal structure	
<i>EPEC</i>	CesD	151	7.4	EspB, EspD	No	
<i>Pseudomonas</i>	PcrH	167	4.6	PopB, PopD	No	
<i>Salmonella</i>	SicA (SPI-I)	165	4.6	SipB, SipC	No	
<i>Salmonella</i>	SscA (SPI-II)	157	8.0	SseC, SseD	No	
<i>Shigella</i>	IpgC	155	4.4	IpaB, IpaC	No	
<i>Yersinia</i>	SycD	168	4.5	YopB, YopD	No	
Class III :						
Organism	Chaperone	Size (aa)	pI	Substrate	Crystal structure	
<i>EPEC</i>	CesA	107	9.5	EspA	Yes (in complex)	
<i>Pseudomonas</i> (?)	PscE	67	6.1	PscF	No	
<i>Yersinia</i> (?)	YscE	66	6.7	YscF	Yes	

Structure of T3S chaperones and complexes :

The structure of many different chaperones has been solved but not in all Classes. The Class I chaperones was intensively studied with about 10 structures resolved. In the Class III, only a few chaperones were crystallized, and their structure appeared to be completely different from the Class I folding. Finally, very little is known about Class II chaperones, with no crystallographic data available so far.

Class I chaperones : Chaperones of the effectors

The primary sequence of T3S chaperone is very variable. However, in Class I the secondary structure is surprisingly well conserved, composed of three α -helices and five β -strands with the following topology: $\alpha_1\beta_1\beta_2\beta_3\alpha_2\beta_4\beta_5\alpha_3$ (Fig. 8) (Birtalan and Ghosh, 2001); (Stebbins and Galan, 2001); (Luo *et al.*, 2001); (Birtalan *et al.*, 2002); (van Eerde *et al.*, 2004); (Buttner *et al.*, 2005). At the three-dimensional level, the folding of the Class I chaperone is conserved through the different T3S systems (Fig. 9).

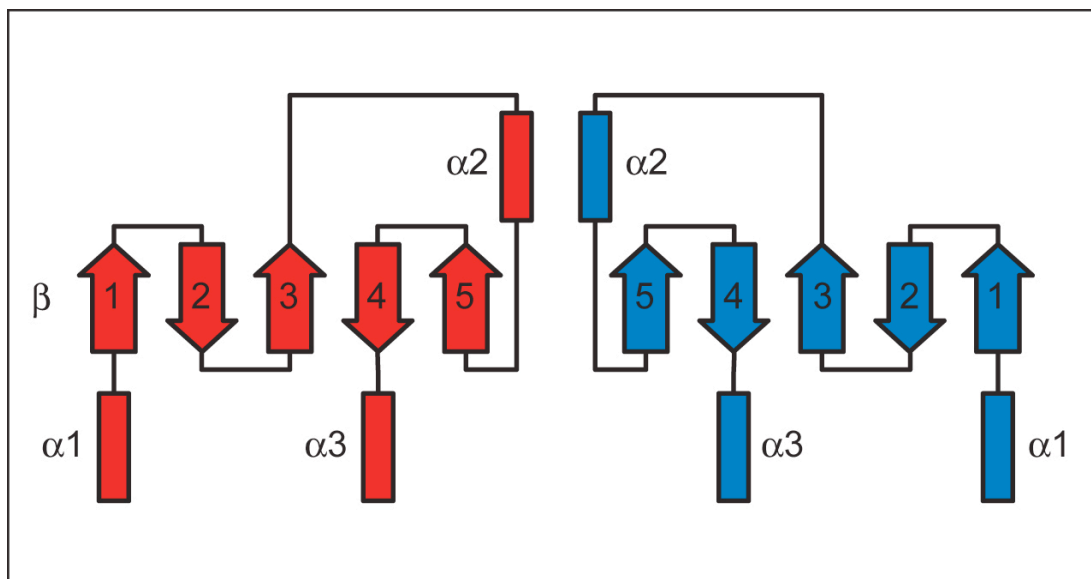

Figure 8 : Class I chaperones have a conserved secondary structure.

The topology of Class I chaperone is conserved. The secondary structure is composed of three α -helices (rectangles) and five β -strands (arrows). Class I chaperones associates in dimers mainly via the α_2 helices.

Class I chaperones associate in dimer via the central α -helix (α_2) and the adjacent β -strands. This interaction is mainly mediated by hydrophobic residues. So far this organization by pair seems to be conserved among the Class I chaperones. Even in the case of Spa15, where the

orientation of the dimer subunits is tilted from 30°, the overall arrangement is similar. Complexes are homodimeric, but a heterodimeric complex, SycN-YscB the chaperones of YopN, has also been described (Jackson *et al.*, 1998); (Day and Plano, 1998). However, the folding and the heterodimer arrangement is canonical (Schubot *et al.*, 2005).

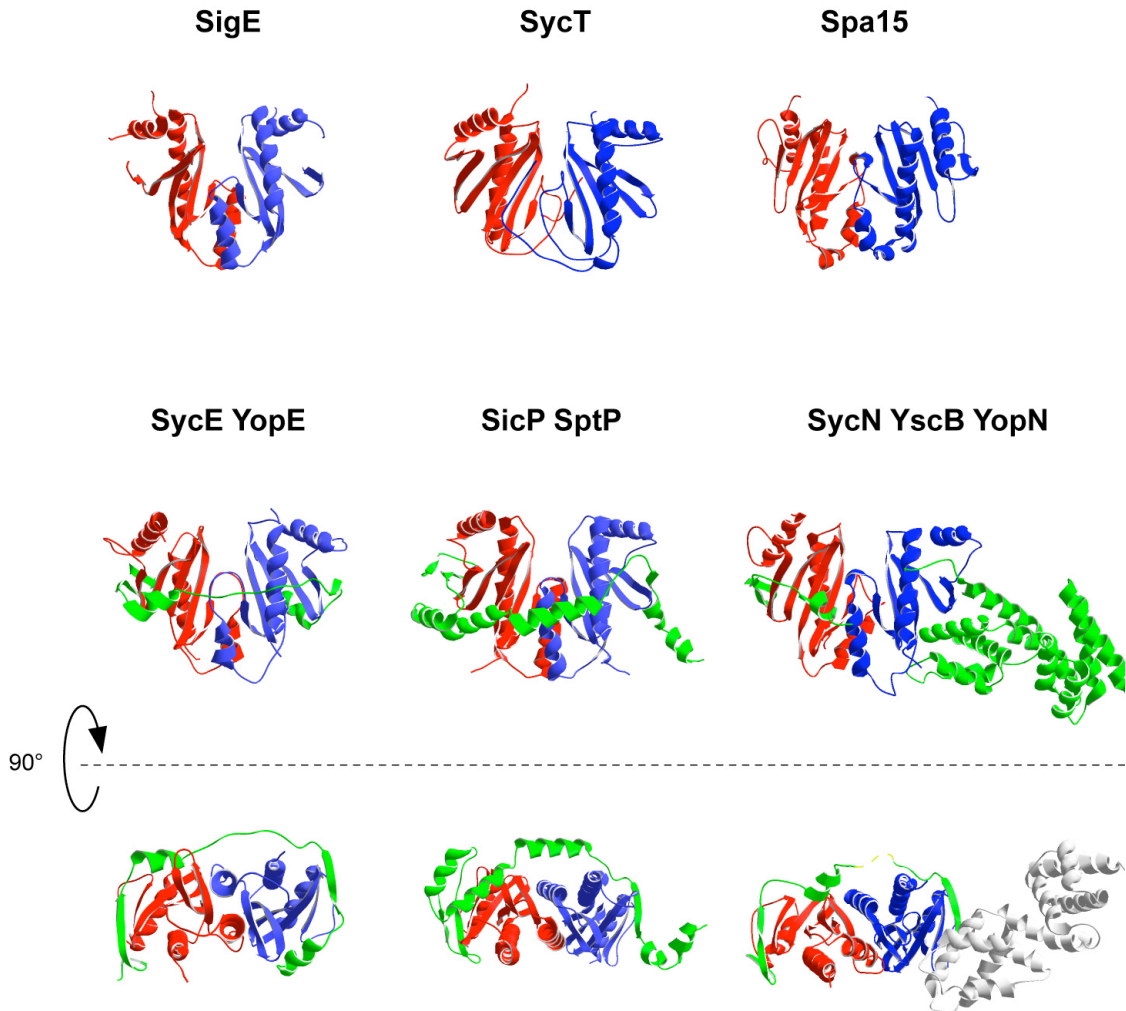

Figure 9 : Three dimensional structure of Class I chaperones.

Overall structure of Class I chaperones, each monomer is represented in red or blue. Associated chaperones binding domains or substrates are shown in green. A rotation towards the horizontal axis provides a bottom view and reveals the horse shoe like configuration of the chaperone binding domain round the dimer (part of YopN has been shaded in gray to distinguish its CBD around the SycN-YscB dimer). Structures are from the PDB, references: SigE 1K3S, SycT 2BSJ, Spa15 1RY9, SycE-YopE 1L2W, SicP-SptP 1JYO, SycN-YscB-YopN 1XKP, InvB-SipA 2FM8.

InvB SipA



Class I chaperones are known to bind their cognate effector in N-term, roughly within the 100 first amino-acids, downstream from the N-terminal secretion signal (Wattiau and Cornelis, 1993); (Woestyn *et al.*, 1996); (Fu and Galan, 1998); (Jackson *et al.*, 1998); (Lee and Galan, 2003); (Buttner *et al.*, 2005); (Lilic *et al.*, 2006); (Letzelter *et al.*, 2006). These interaction domains, called Chaperone Binding Domains (CBDs), have been delineated using various methods: pull-downs, limited proteolysis, or have been deduced from structural data. In association with the chaperones, those domains are poorly folded (Fig. 9) (Stebbins and Galan, 2001); (Birtalan *et al.*, 2002); (Schubot *et al.*, 2005); (Lilic *et al.*, 2006). Mostly extended, with few short α -helical or β -strand structure, they wrap around the chaperone dimer in a horseshoe-like conformation. Crystal structures of chaperones, bound together with the CBD of their cognate effector, revealed the nature of the interactions leading to the substrate recognition. Hydrophobic patches and charges exposed at the surface of Class I dimers mediate the binding to the effector via hydrophobic interactions (Stebbins and Galan, 2001); (Birtalan *et al.*, 2002); (Schubot *et al.*, 2005); (Lilic *et al.*, 2006). Many hydrogen bonds can also occur at the surface of the dimer and their distribution is variable from one chaperone to another. The distribution of the hydrophobic patches, and charges at the surface of the dimer constitute the determinants of the binding specificity to the CBD. The crystal structure of SipA-InvB complex by Lilic *et al.*, revealed the existence of a conserved binding motif in the N-terminal part of the effectors. This domain, called β -motif by the authors, binds one of the hydrophobic patches described earlier by Birtalan *et al.* (Birtalan *et al.*, 2002). This patch was renamed there as: "binding pocket". The interaction between those two domains (β -motif - binding pocket) appears to be crucial in order to have a stable chaperone-substrate complex (Lilic *et al.*, 2006).

Class II chaperones : Chaperones of the translocators

The structure and the organization of the translocator chaperones is still unknown. Only a few data have been collected and no crystal structure has been resolved so far. Nevertheless Pallen *et al.* noticed the presence of tetratricopeptide repeats (TPRs) in the Class II chaperones (Pallen *et al.*, 2003). These motifs discovered in eukaryotes are protein-protein interaction modules consisting in a degenerated 34 residues repeat often arranged in tandem. Structurally, they fold in a continuum of adjacent α -helices, forming a peptide binding groove. Usually involved in protein-protein interaction, they are found in chaperone complexes involving Hsp70 and Hsp90. There, proteins like STI1, Cyp40 and Tom70 use TPRs to bind to the heat shock proteins. The structure of Class II chaperones would then differ from the common α - β folding of the Class I. A three dimensional modeling of SycD in complex with part of the amphipatic helix of YopD (residues 280 to 292) has been performed to illustrate YopD fitting in the binding groove (Pallen *et al.*, 2003). Studies by Edqvist *et al.* allowed to identify two different interaction

surface on the putative all α -helical structure of SycD, one interacting with YopB, one with YopD (Fig. 10) (Edqvist *et al.*, 2006). All these results and models would fit with the fact that SycD can bind individually to YopB or YopD. Moreover, as YopB and YopD have multiple chaperone interaction sites, the chaperone structure and the binding mode could be different from the one observed for the Class I chaperones. Accordingly, Schmid *et al.* showed by circular dichroism the α -helical nature of SycD (Schmid *et al.*, 2006). They also demonstrated by gel filtration and crosslinking that purified SycD could dimerize, like the Class I chaperones. The resolution of Class II chaperones structure would be helpful to bring some light on the situation.

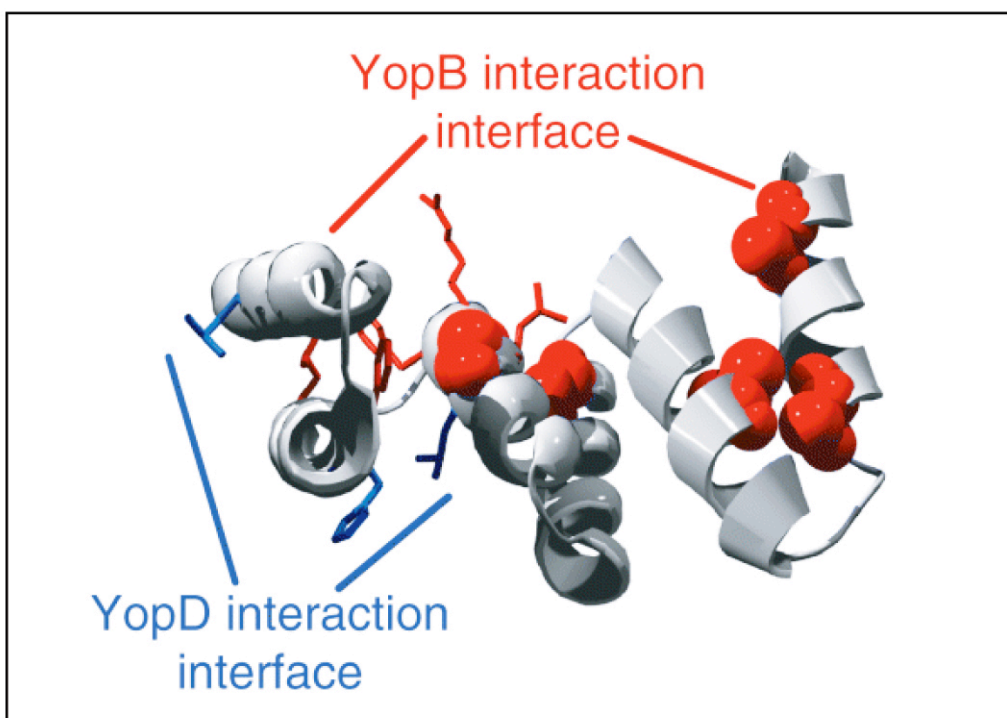

Figure 10 : Three dimensional model of the Class II chaperones SycD.

Model of SycD/LcrH structure based on the study of tetratricopeptide repeats (Edqvist *et al.* 2006). The structure is all α -helical. The residues with phenotypes affecting binding or secretion of substrates are highlighted in the structural model. Those with extensive side chains are depicted in stick format, while those with small side chains that project towards the concave surface of the theoretical structure are shown in space-filling format. In this structural model, residues on the outside of the molecule with phenotypes affecting binding or secretion of YopD are highlighted in blue, while residues in the binding groove with phenotypes affecting binding or secretion of YopB are highlighted in red. The two groups of residues clearly fall on alternate faces of the protein in the structural model.

Class III chaperones : Chaperones of the T3S apparatus subunits

For a long time the only data available about Class III chaperones were coming from the flagellar field. As mentioned already, flagellum and T3S are evolutionarily linked and their basal body share strong structural similarities. Flagellar subunits are also secreted via a T3S pathway. Proteins like FlgN interacting with hook associated proteins (FlgK and FlgL), or FliT preventing the oligomerization of the filament cap subunits (FliD) can be considered as chaperones (Fraser *et al.*, 1999). FliS the chaperone associated with the filament subunits (FliC) was proposed to prevent intracellular polymerisation (Auvray *et al.*, 2001); (Evdokimov *et al.*, 2003). FliS has a compact all α -helical structure, different from the Class I chaperones and the Class II chaperones (Evdokimov *et al.*, 2003). FliS was shown to form a dimer, alone or in complex with FliC (Auvray *et al.*, 2001). However according to another study (Muskotal *et al.*, 2006), and the crystal structure resolved by Evdokimov *et al.*, FliS is monomeric and binds FliC in a 1:1 ratio. The C-terminal binding domain of FliC (residues 479-518) wraps around the chaperone (Fig. 11), with slightly stretched, but still significant secondary structure. Hydrophobic interactions are also the key of the association between the two proteins.

Beside the flagellar protein, only one Class III chaperone structure has been determined: CesA has been crystallized with its substrate EspA, the T3S filament subunit of enteropathogenic *E. Coli* (EPEC) (Yip *et al.*, 2005). CesA adopts an elongated all α -helical structure, with an overall hairpin shape (Fig. 11). The inner residues facing this structure are mainly non polar, generating a hydrophobic groove allowing EspA binding. Two long α -helices, N-terminal (31-59) and C-terminal (148-190) constitute the chaperone binding site of the filament subunit. This four helices structure of the CesA-EspA complex, is quite peculiar compared to the FliS-FliC complex.

No more identified Class III chaperone has been crystallized so far. However, the structure of other T3S components is already determined and can be compared to the structures of the CesA-EspA complex. EspA interacts with its chaperone via two antiparallel α -helices (Fig. 11). Comparable antiparallel α -helices are found in the structure of the needle subunits of *Burkholderia* and *Shigella* (Fig. 12). No Class III chaperone has been identified so far for these compounds. However, the needle subunits of *Pseudomonas* (PscF) or *Yersinia* (YscF) are interacting with other proteins in the cytosol of the bacteria, PscE and YscE respectively, and are significant chaperone candidates (Quinaud *et al.*, 2005); Sorg and Cornelis, unpublished). Interestingly, the structure of YscE and CesA are fairly similar (Fig. 12).

Identification and characterization of other Class III chaperones as well as future crystallographic studies will allow to determine whether Class III chaperones encloses proteins with heterogeneous structures (E.g. FliS, CesA) or if the structural differences state between the flagellar chaperones and the T3S apparatus chaperones. New insight on this family of proteins will maybe lead to a new classification.

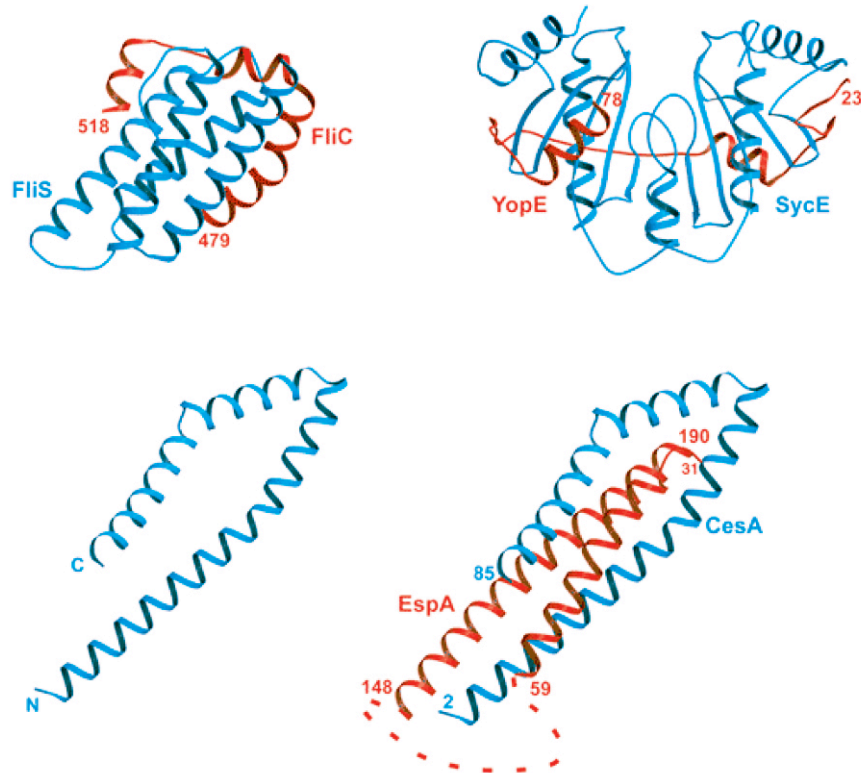

Figure 11 : Three dimensional structure of the Class III chaperones FliS And CesaA:

The structure of the Class III chaperones with their substrate (FliS-FliC and CesaA-EspA) is compared to the structure of YopE bound to SycE (Class I chaperone). The structure of the Class III chaperones is all α -helical. Chaperones are in blue and substrates are in red. YopE and FliC are binding their chaperones in an extended conformation. In a different way, CesaA binds the N-terminal and C-terminal α -helices of EspA.

About chaperone classes...

The sorting of chaperones into three classes has been established by Parsot *et al.* (Parsot *et al.*, 2003). This proposition, is based on the kind of substrate chaperone are associated (I Effectors, II Translocators, III Apparatus subunits) and can appear arbitrary. Initially, characteristics like molecular weight, pI, genetical location, suggested all T3S chaperones to be similar. Crystallographic data, showed that T3S chaperones present a structural diversity between the three classes. The Class I is from far the best characterized with over 10 structures resolved. Although the primary sequence varies a lot from one Class I chaperone to another, the three dimensional structure of the proteins within this class is remarkably well conserved. This structure made of three α -helices and five β -strands is completely different from the all α -helical structure of the Class III. Indeed, chaperones of the different classes appear to be from different structural families.

Only a few chaperones from the Class III were crystallized so far. The chaperones of the flagellum were initially considered as elements of the Class III. FliS was the first one to be crystallized with its substrate FliC (the flagellar filament subunit) (Evdokimov *et al.*, 2003). The flagellum and the T3S system derive probably from a common ancestor. But the similarities between the two systems are limited to the basal body. Therefore the link between FliS, the chaperone of the filament subunit -a distal element of the structure- and the Class III is arguable and would explain such a singular structure. The structure of EPEC T3S filament subunit EspA in complex with the chaperone CesA brought new informations (Yip *et al.*, 2005). As for FliS, CesA presented an all α -helical structure. However, the difference between the two chaperone structures is important, and could reflect the difference between two different systems (Flagellum vs. T3S system). Accordingly the structure of YscE (Phan *et al.*, 2005) a chaperone candidate of YscF (the T3S needle subunit), is also different from the one from FliS, but the overall shape is quite close to the one of CesA (Fig. 12). Structures of the chaperones within the Class III could be similar, like chaperones structure within the Class I. This would lead to the exclusion of the flagellum chaperones from the Class III. Another possibility would be that Class III chaperones regroup a heterogeneous set of chaperones. Additional data are still missing to consider the diversity of the Class III.

No crystallographic study has been made so far on Class II chaperones. The few data collected from Pallen *et al.* propose a model in which the chaperones of the translocators would also have an all α -helical structure (Pallen *et al.*, 2003). This structure based on tetra-tricopeptide repeats would differ from the one observed in the Class III and the Class I. Therefore, the Class III, the Class I and probably the Class II proteins are from different structural families. Future resolution of other T3S elements will help to confirm or redefine the Classes of T3S chaperones according to their structure.

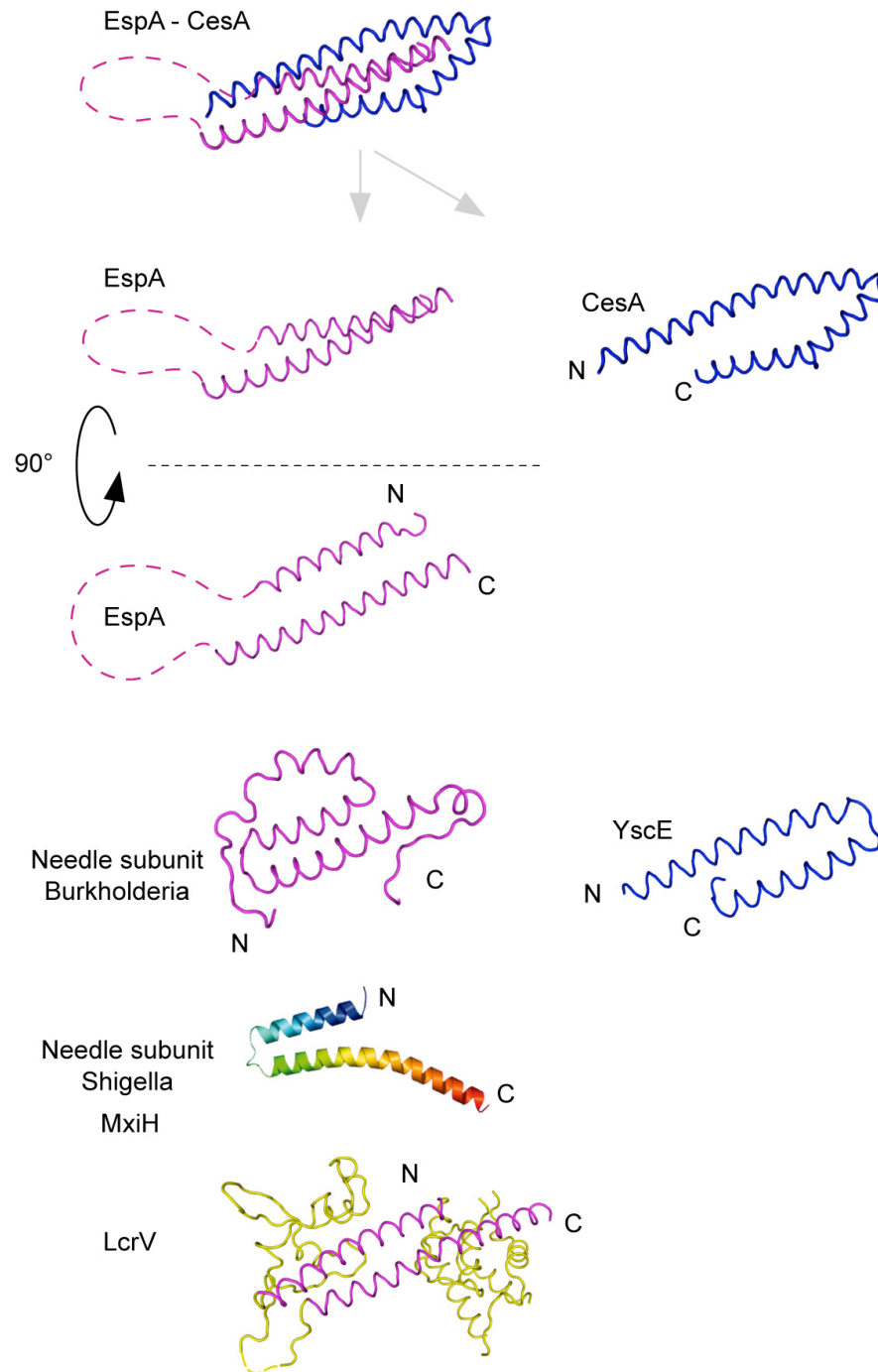

Figure 12 : The structure of the Cesa-EspA complex is presented with several T3S apparatus subunits and the putative chaperone YscE.

EspA is shown after rotation toward the horizontal axis. The antiparallel α -helices composed by the N-terminal and C-terminal of EspA are involved in the binding to the chaperone Cesa. These antiparallel helices have some structural equivalents in the needle subunits of *Burkholderia*, *Shigella* and in the *Yersinia* needle tip protein LcrV. The chaperone Cesa has a similar structure to the chaperone candidate YscE of *Yersinia*. Structures are from the PDB, references: 1XOU (EspA-Cesa); 1ZWO (YscE); 2G0U (Needle subunit *Burkholderia*); 1R6F (LcrV).

Multiple functions of T3S chaperones:

T3S chaperones protect their substrate from premature intra- or inter-molecular interactions in the bacteria, as chaperone are supposed to do. However, the role of T3S chaperones is not restricted to this task and their influence on the system is far more complex. Some roles proposed would derive directly from the chaperoning action; like storage and stabilization of their partner, or acting as anti-folding factors, in order to maintain the substrate in a secretion competent state. In addition, they seem to be involved at many different levels in the T3S process, displaying versatile functions. From their central position in the T3S mechanism, chaperones appear to have an effect on the hierarchy of secretion, on the regulation of the secretion, on the secretion pathway specificity... T3S chaperones can be sorted in three classes according to the nature of their structure and their properties. The three classes will be described separately.

Class I : Chaperones of the effectors

Storage and stabilization :

Many data have shown that chaperones help to stabilize their substrate. For instance, the effectors YopE (SycE) (Frithz-Lindsten *et al.*, 1995), SptP (SicP) (Fu and Galan, 1998), Tir (CesT) (Abe *et al.*, 1999), and IpgD (IpgE) (Niebuhr *et al.*, 2000), are better expressed, or have an extended life time in the bacterial cytosol when bound to their chaperone (under brackets). However, this effect is not universal for Class I chaperones. Spa15, a multivalent chaperone of *Shigella*, is required for the stability of IpgB1, but not for the one of IpaA, another of its substrates (Page *et al.*, 2002). Also, the intrabacterial stability of YopH is not affected by the absence of SycH. The effector cannot be secreted by *sycH* deficient mutant bacteria and accumulates in the cytosol (Wattiau *et al.*, 1994). Other studies showed that although the secretion of YopE was reduced in a *sycE* mutant, the intracellular concentration was approximately equivalent to the wild-type level (Wattiau and Cornelis, 1993). In this situation, even if the stability is decreased, the pool available inside the bacterial cell seems to be similar.

Chaperones could also stabilize their substrate by preventing their aggregation. Without their cognate chaperone, effectors like YopE (Birtalan *et al.*, 2002), YopO, YopT (Letzelter *et al.*, 2006), SipA (Lilic *et al.*, 2006) have a clear tendency to aggregate. In absence of their chaperone, presynthesized proteins aggregate in the bacterial cytosol through their CBD. This aggregated state is incompatible with export. By preventing aggregation to occur, chaperones keep their substrate soluble and fit for export. Indeed, stored proteins require their chaperone to be exported. In *Shigella*, presynthesized IpaA can be secreted only in presence of its chaperone (Page *et al.*, 2002). In *Yersinia*, the translocation of YopE after protein synthesis inhibition is also chaperone dependent (Lloyd *et al.*, 2001).

Secretion and translocation : Chaperones as targeting factors :

Chaperone knockouts usually fail to export their substrate efficiently. *In vitro*, some effectors lacking their cognate chaperone are less secreted. Moreover, during cell infection, they are not translocated in the eukaryotic cell. To explain the export deficiency in chaperone mutants, other hypotheses than the consequence of CBD aggregation in the bacteria have been proposed. For instance, chaperones would facilitate the recognition of the substrate by the T3S apparatus and play a targeting role (Fig. 13). The effector YopE with a frameshifted secretion signal, is exported by the wild-type, but not by the mutant lacking the SycE chaperone (Lloyd *et al.*,

2001); (Cheng *et al.*, 1997). Without the export signal, targeting of the effector to the T3S apparatus would be mediated by the chaperone. Recently, Akeda and Galan showed that InvC, the *Salmonella* SPI-1 ATPase is involved in substrate recognition. A direct interaction between effector-chaperones complex and the ATPase of the T3S system has been demonstrated (Akeda and Galan, 2005). The N-terminal part of the effector, or the chaperone alone was shown to bind InvC. Thus, chaperones could participate in the targeting, by binding and presenting the substrate to the T3S ATPase (Fig. 13).

Structural analysis of effector-chaperones complexes also suggested a role in substrate delivery to the T3S. By binding immediately downstream from the export signal, chaperones could keep the N-terminal signal exposed, preventing its folding within the structure. A “three-dimensional secretion signal” has been proposed (Birtalan *et al.*, 2002), but the structure of new chaperone-effector complexes (Schubot *et al.*, 2005); (Lilic *et al.*, 2006) revealed quite some diversity in the effector chaperone binding domain path around the chaperone dimer. This observation weakened the idea of a conserved overall structure constituting a three-dimensional secretion signal (Lilic *et al.*, 2006).

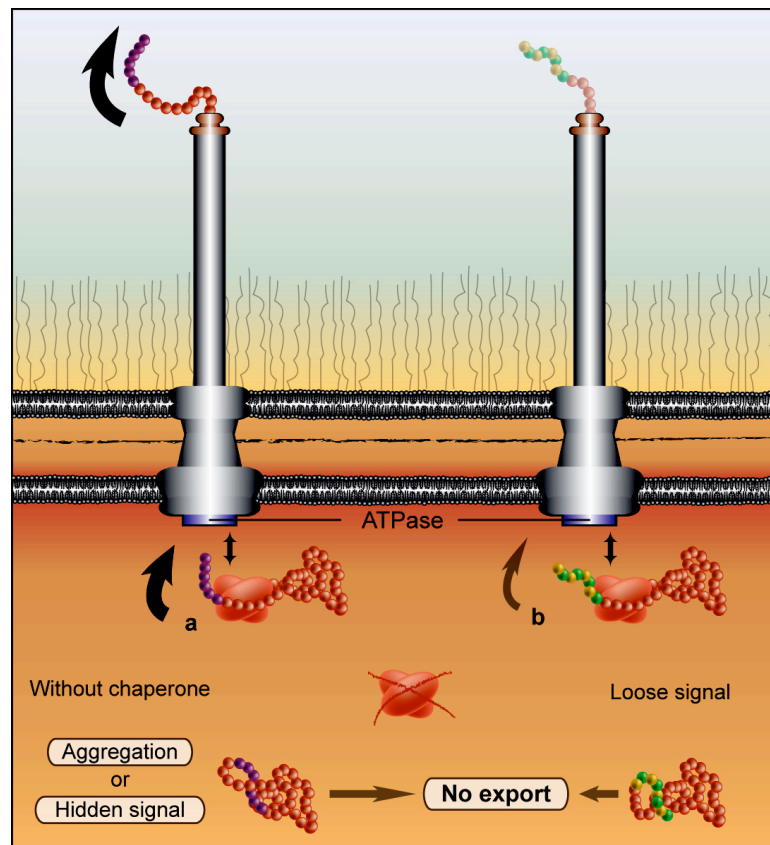

Figure 13 : Targeting functions of the Class I Chaperones.

- Chaperones prevent the folding of the secretion signal within the structure, or the aggregation of effectors. The secretion signal is maintained exposed and the effector soluble.
- Chaperones present effectors with a defect in their secretion signal to the secretion apparatus. Chaperones-effector complexes interact with the ATPase and mediate the recognition.

Another implication of the chaperones in targeting has been proposed by Lee and Galan (Lee and Galan, 2004). In absence of their chaperone binding domains, SptP_{Δ35-61} and SopE_{Δ39-77} are secreted via the flagellum apparatus, but not via the T3S machinery anymore. The SptP₁₋₃₅ - PhoA fusion can also be secreted by the flagellum. The authors proposed that the N-terminal part of the effector would contain an ancestral secretion signal common to both apparatus. The presence of the chaperone binding domain and the binding of the chaperone would confer the T3S pathway specificity to the effector protein. However, monitoring internalization of *Salmonella* into cells, SopE_{Δ39-77} cannot complement a SopE loss-of-function mutation, indicating that even though it was secreted, it cannot be translocated into host cells via the flagellar apparatus. Similar investigations were performed by Ehrbar *et al.*, testing different SopE mutants with poly-alanine replacement in the chaperone binding domain (Ehrbar *et al.*, 2006). Mutants able to bind the InvB chaperone are secreted in a T3S dependent manner and can be delivered into host cells via the T3S apparatus. Mutants unable to bind InvB are secreted through the flagellum, but not translocated.

The chaperone pathway specificity observed in *Salmonella* is probably not applicable to all the T3S. In *Yersinia*, the effector YopO is secreted with or without its chaperone binding domain, in a T3S dependent manner (Letzelter *et al.*, 2006). Moreover, YopE or YopO lacking their chaperone binding domain are maybe not delivered into host cells when expressed in a wild-type bacteria, but can be translocated by multi- effector deficient bacteria, excluding any flagellar pathway (Boyd *et al.*, 2000), (Letzelter *et al.*, 2006). Therefore the signal for T3S targeting does not involve the chaperone binding domain and the chaperone. Effector and chaperone would have co-evolved, to optimize the recognition and the uptake by the T3S apparatus. The determinant of the T3S signal would still be present in the N-terminal signal sequence, however the presence of the chaperone would support the effector uptake. Indeed, in this background, effectors like YopE₁₅-Cya, YopE_{Δ17-77} or YopO_{Δ20-77}-Cya with a signal sequence, but without their chaperone binding domain are still translocated (Boyd *et al.*, 2000), (Letzelter *et al.*, 2006). However they cannot compete against the other Yops in an optimized process like the wild type T3S. Subsequently, Class I chaperone have been proposed to play a derivative of targeting function, by helping to compete against other substrates and optimizing their delivery.

Antifolding, unfolding factors :

Given the size of the inner diameter of the T3S needle, proteins cannot be exported in a folded way (Blocker *et al.*, 2001); (Feldman *et al.*, 2002). After the resolution of the SicP-SptP complex structure, Stebbins and Galan proposed that chaperone could keep their substrate unfolded in a

secretion competent state (Stebbins and Galan, 2001). The resolution of new complexes with full length substrate like YscB-SycN-YopN (Schubot *et al.*, 2005), or InvB-SipA (Lilic *et al.*, 2006) revealed that Class I chaperones only maintain a discrete N-terminal CBD unfolded. Other experiment evaluating the catalytic activity of YopE (Birtalan *et al.*, 2002), YopH (Neumayer *et al.*, 2004), YopO (Letzelter *et al.*, 2006) bound to their chaperone revealed a standard enzymatic activity, implying a correct folding of the enzymatic core. By maintaining the N-terminal CBD unfolded, chaperones could facilitate the unfolding of the protein prior export by the T3S, initializing the process mediated by the ATPase (Akeda and Galan, 2005).

Control, regulation and hierarchy of secretion :

In *Yersinia*, LcrQ/YscM1 is a regulator that exerts a negative feedback on the virulence genes (Rimpilainen *et al.*, 1992); (Stainier *et al.*, 1997). LcrQ/YscM1 binds the Class I chaperone SycH (Cambronne *et al.*, 2000); (Phan *et al.*, 2004). When the T3S apparatus is active, LcrQ/YscM1 is exported and its depletion in the bacteria lead to an “up-regulation” of the virulence genes (Fig. 14). The over-expression of SycH has the same effect as the depletion of YscM in the bacteria: the production of several T3S proteins is increased (Cambronne *et al.*, 2000). Since the export of LcrQ/YscM1 is SycH dependent, the Class I chaperone is involved in a way in this regulation process.

Another study proposed that LcrQ/YscM1 could control the secretion activity directly at the level of the T3S apparatus (Wulff-Strobel *et al.*, 2002). Before activation of the T3S system, the LcrQ/YscM1–SycH complex would interact with a hypothetical site on the apparatus. There the LcrQ/YscM1–SycH complex is hypothesized to exert its down-regulation feedback. Upon activation LcrQ/YscM1 would be first secreted. The release of LcrQ/YscM1 would leave SycH free to associate with YopH. The presence of SycH directly on the apparatus would then prioritize the secretion of YopH on the other Yops. SycH would then be involved in the regulation process by setting a hierarchy in substrate secretion. No additional data came so far to support this hypothesis.

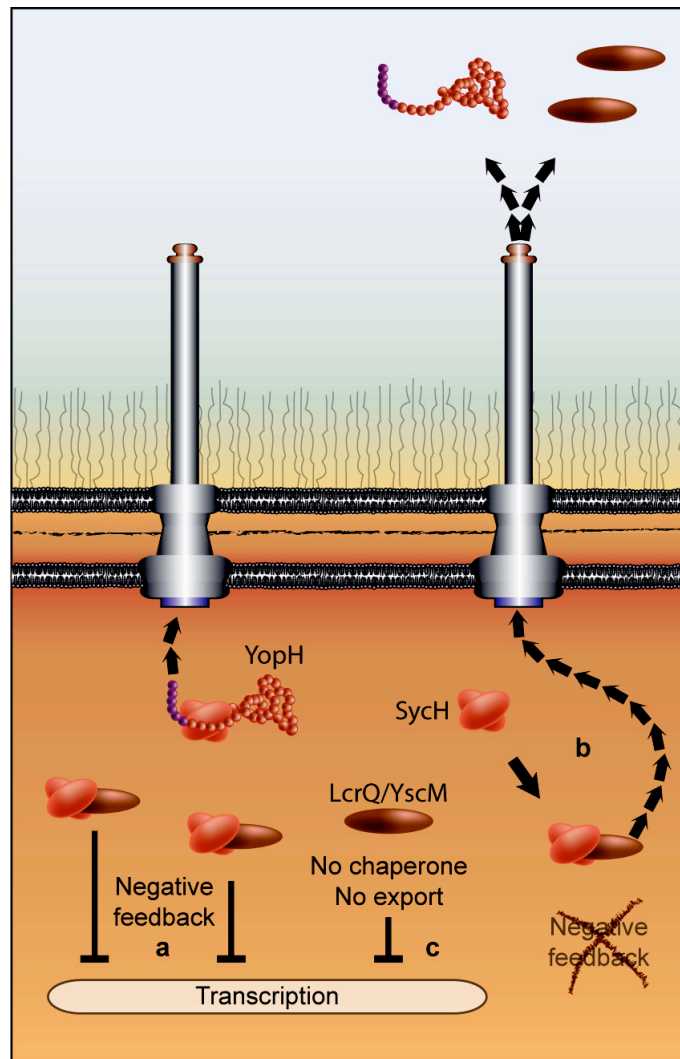

Figure 14 : Chaperones involved in the control of the export activity.

The Class I chaperone SycH can bind its cognate effector YopH, as well as the LcrQ/YscM. LcrQ/YscM exert a negative feedback on the transcription of virulence proteins (a). When secretion is active, LcrQ/YscM is exported releasing the negative feedback inside the cell (b). The secretion of LcrQ/YscM is strictly SycH dependent, involving the chaperone in the process (c).

Class II : Chaperones of the translocators

Storage and stabilisation:

In *Shigella*, the translocators IpaB and IpaC associate in a complex once exported into the extra-cellular milieu (Menard *et al.*, 1994). Each of them binds the Class II chaperone IpgC individually. Both are degraded in the absence of IpgC in the bacterium. IpaB alone is unstable due to two hydrophobic domains in the C-terminal part. Binding of the chaperone stabilizes this substrate. On the other hand, IpaC is stably expressed in *E.coli*. Their common degradation in *ipgC* mutants is due to the premature association of IpaB and IpaC in the cytosol. IpgC prevents this event, allowing the storage of the two proteins (Menard *et al.*, 1994). This observation is common to several T3S systems. In *Salmonella*, SicA stabilizes and prevents the association of the translocators SipB and SipC (Tucker and Galan, 2000), as well as PcrH with PopB and D in *Pseudomonas* (Schoehn *et al.*, 2003). In *Yersinia*, SycD fulfils the same function binding YopB and D (Wattiau *et al.*, 1994); (Neyt and Cornelis, 1999b). In addition, YopB is toxic when expressed without SycD in *E.coli* (Neyt and Cornelis, 1999b). The protective role of the chaperone would serve the protein YopB as well as the bacteria itself.

Control, regulation and hierarchy of secretion:

T3S genes are generally activated by transcriptional regulators from the AraC/XylS family. Upon appropriate stimulus they activate transcription of the virulence genes. This activity can be modulated by some elements of the T3S like chaperones. In *Salmonella*, Darwin and Miller showed that InvF the T3S transcriptional regulator binds the Class II chaperone SicA. Both proteins are required to activate the transcription of the *sicA*, *sigD* and *sopE* promoters of the respective operons (Darwin and Miller, 2001); (Darwin and Miller, 2000). A similar transcriptional regulation involving the Class II chaperone IpgC was found in *Shigella* (Mavris *et al.*, 2002). MxiE and IpgC, the respective counterparts of InvF and SicA, are involved in transcription of the *virA* and *ipaH* genes. These genes are induced only when the secretion is active. The Mxi-IpgC interaction sets a type of hierarchy in the secretion process. First, IpaB and IpaC, the substrates of IpgC, are secreted. Next, free IpgC can bind MxiE and activate transcription of the *virA* and *ipaH* genes (Fig. 15). Then, the second set of effector proteins (VirA and IpaH) can be secreted. MixE alone is not able to activate the transcription and requires IpgC as a co-factor. However, no direct interaction has been shown between the two proteins.

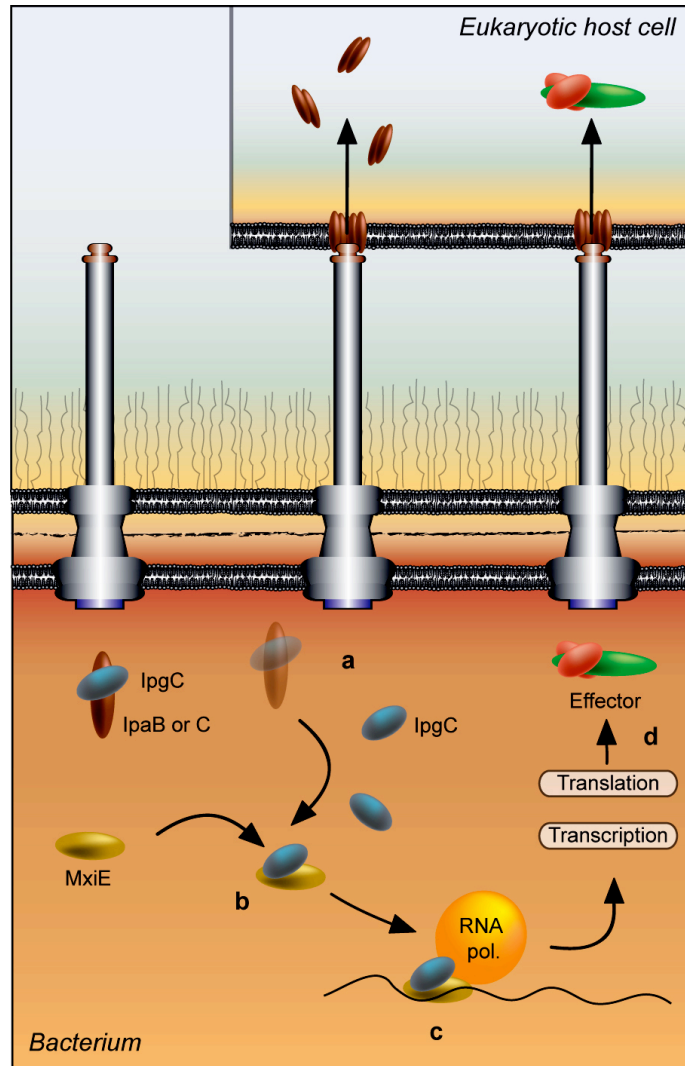

Figure 15 : Regulation properties of the Class II chaperones.

In the cytosol, the Class II chaperone IpgC is associated with the translocators IpaB and IpaC. Once IpaB and C are exported IpgC is released (a). Free IpgC can bind and activate the transcriptional activator MxiE (b) initiating the transcription of the VirA and IpaH genes (c). A second set of effector is then synthesized and can be exported (d).

A recent study identified an additional partner for the secretion control in *Shigella*. OspD1 and its chaperone Spa15 would play an anti-activator role, preventing the interaction of MxiE with IpgC (Parsot *et al.*, 2005). When the T3S system is inactive, IpaB and IpaC are associated independently with IpgC, which prevents premature interactions between the two translocators and titrates IpgC. OspD1 is associated with Spa15, which stabilizes OspD1 and probably maintains it in a secretion competent state. MxiE is associated with the Spa15–OspD1 complex, which both stabilizes MxiE and prevents it from being activated by IpgC. Upon T3S activation, export of IpaB and IpaC liberates IpgC. However, this is not sufficient to activate MxiE as long as OspD1 is present in the cytoplasm. If the TTS apparatus remains active, transit of OspD1 occurs, releasing MxiE. Then, MxiE can interact with IpgC and activate transcription. Thus, two chaperones IpgC (Class II) and Spa15 (Class I) are involved in this regulation process.

In *Yersinia*, three out five genes of the translocator operon have an impact on the bacterial growth in low calcium condition at 37°C. They were subsequently considered to encode regulators (Bergman *et al.*, 1991). The chaperone SycD is one of them and was initially called LcrH for “Low calcium response H”. The deletion of *sycD*, or one its substrates gene *yopD*, results in the same phenotype: the exported virulence proteins are constitutively produced. The YopD-SycD complex was then identified as the regulator of the virulence gene expression (Anderson *et al.*, 2002); (Francis *et al.*, 2001). Mutants unable to constitute a stable complex lose their regulatory properties, they constitutively produce the virulence proteins. Thus, it was proposed that the complex establishes the negative regulatory loop, rather than the chaperone or the YopD translocator alone (Francis *et al.*, 2001). This SycD-YopD complex has also been shown to bind and contribute to the degradation of the *yopQ* mRNA, suggesting a post-transcriptional regulation mechanism (Anderson *et al.*, 2002).

Class III : Chaperones of the T3S apparatus subunits

Storage and stabilisation:

Chaperones of the Class III are also involved in production and storage of their substrate. FliS is a small acidic and cytoplasmic protein of the flagellum apparatus. It is required for the export of FliC, the filament subunit of the flagellum (also called flagellin). *In vitro*, flagellar filaments can grow from seeds (short pieces of flagellum) by addition of purified FliC. This polymerisation is prevented by the presence of the chaperone FliS (Auvray *et al.*, 2001); (Evdokimov *et al.*, 2003).

In T3S, several proteins have a similar behavior. Purified EspA (the subunit of the EPEC filaments) forms filamentous polymers spontaneously. CesA forms a complex when co-expressed with EspA. No filamentous structure appears in these conditions, suggesting that the binding of CesA to EspA prevents polymerization. In *Pseudomonas aeruginosa*, PscE prevents the polymerization of PscF, the needle subunit of T3S apparatus (Quinaud *et al.*, 2005). However PscG, a third protein takes place in the PscE-PscF complex. But so far, the precise role of this protein is not known. The *Yersinia* homologues YscE, YscF and YscG act in a identical way (Sorg and Cornelis unpublished).

LcrV, the protein forming the tip structure at the end of the T3S needle is functionally related to EspA. The EspA filaments polymerize at the tip of the EspF needles. Although the *Yersinia* tip is not a filamentous structure, LcrV forms a multimeric complex at the tip of the needle (Mueller *et al.*, 2005). LcrV is known to associate with LcrG, which could be a chaperone for LcrV. The idea that LcrG prevents the oligomerization of LcrV has not been investigated.

Final word:

One recurrent role of T3S chaperones is the stabilization of the substrate, allowing its storage into the bacteria. According to their nature and their structure, T3S apparatus subunits require the assistance of Class III chaperones into the cytosol in order neither to aggregate nor to polymerize. As well, Class II chaperones protect the hydrophobic domains and the mutual interaction of the translocators inside the bacteria. Other associated chaperone functions, such as regulation, could have evolved later. For effectors the situation is a bit different as some do have and need a chaperone and some other do not. Why?

The role of Class I chaperones could be to prevent aggregation of the effector, to present the secretion signal to the apparatus or to keep it exposed... Actually to keep effectors in a secretion competent state. So far, no chaperone binding domain has been shown to be part for the catalytic core of its effector. So why a domain disturbing storage and secretion would still be kept in a system, as well as an additional chaperone to prevent its negative side effects? Effector can also be somehow targeted to the host cell without CBD and chaperone, when not in "competition" with all the other effectors. Additionally, some effectors are working without chaperone. Thus, could the CBD be required to fulfill a function, creating the need for a chaperone?

II. Aim of the Thesis

Aim of the thesis :

In all pathogenic *Yersinia* (*Y.enterocolitica*, *Y.pseudotuberculosis*, and *Y.pestis*), the open reading frame ORF155 is located upstream of *yopO* and *yopP*. The putative product of this ORF is small (17 kDa), has an acidic pI (4.5) and has a hydrophobic moment plot that resembles the one of the Syc chaperones (Iriarte and Cornelis, 1999a). Therefore, it has the characteristics of a T3S chaperone.

The aim of my thesis was to determine whether the product of ORF155 is a chaperone for YopO and/or for YopP. Since the role of chaperones is still elusive, we investigated its exact function.

III. Research Summary

Research summary :

Several substrates of the T3S system require the assistance of small cytosolic chaperones to be efficiently exported. There are three classes of T3S chaperones. Effector proteins are assisted by Class I chaperones. Although Class I chaperones are well characterized, their main function is still a matter of controversy.

In this thesis, we demonstrate that *orf155* encodes a specific chaperone for the effector YopO that we called SycO. We showed that SycO enhances YopO secretion *in vitro* and is required for translocation of YopO into infected cells. By pulldown assay we demonstrated that residues 20 to 77 of YopO are required and sufficient for SycO binding. Using crosslinking experiments and size exclusion chromatography analysis, we determined the stoichiometry of purified SycO and YopO-SycO complex. SycO alone forms dimers in solution and the YopO-SycO complex has a 1:2 stoichiometry. These results suggested that SycO is a typical chaperone of the Class I.

YopO is a serine/threonine kinase that interacts with Rho and Rac and disrupts the cytoskeleton of the target cells. YopO has been shown to localize at the cell plasma-membrane. By transfection of YopO-EGFP hybrid proteins into HEK293T cells, we demonstrated that the chaperone binding domain (CBD) coincides with the membrane localization domain of YopO. Nevertheless, the CBD was not needed for the kinase activity of YopO. By ultracentrifugation, we also showed that the CBD causes YopO aggregation in the bacteria, when SycO does not cover it. Further, we show that the CBD of YopE and YopT also caused aggregation in the bacteria in the absence of SycE and SycT respectively. YopE, YopT and T3S effectors in other systems also act at the membrane of the eukaryotic host cell.

We propose a new hypothesis concerning the role of T3S chaperones. The sub-cellular localization domain of effectors is aggregation-prone and creates the need for a chaperone inside bacteria. We propose that masking such aggregation-prone localization domains may be a general function for type III effector chaperones.

Statement of my work :

Personal contribution to the article "The discovery of SycO highlights a new function for type III effector chaperones", Letzelter *et al.*, 2006 : I generated all the pML constructs and performed the experiments for figure 1a, 2, 3, 4, 5, 6, 7, supplementary material S2. I contributed to the analysis of the data, I designed all the figures and participated in the writing of the manuscript.

IV. Results

The discovery of SycO highlights a new function for type III secretion effector chaperones

Michel Letzelter¹, Isabel Sorg¹, Luís Jaime Mota^{1,3}, Salome Meyer¹, Jacqueline Stalder¹, Mario Feldman^{1,4}, Marina Kuhn¹, Isabelle Callebaut² and Guy R Cornelis^{1,*}

¹Biozentrum der Universität Basel, Basel, Switzerland and
²Département de Biologie Structurale, Institut de Minéralogie et de Physique des Milieux Condensés (CNRS/UMR 7590) Universités Paris 6 & Paris 7, Paris, France

Bacterial injectisomes deliver effector proteins straight into the cytosol of eukaryotic cells (type III secretion, T3S). Many effectors are associated with a specific chaperone that remains inside the bacterium when the effector is delivered. The structure of such chaperones and the way they interact with their substrate is well characterized but their main function remains elusive. Here, we describe and characterize SycO, a new chaperone for the *Yersinia* effector kinase YopO. The chaperone-binding domain (CBD) within YopO coincides with the membrane localization domain (MLD) targeting YopO to the host cell membrane. The CBD/MLD causes intrabacterial YopO insolubility and the binding of SycO prevents this insolubility but not folding and activity of the kinase. Similarly, SycE masks the MLD of YopE and SycT covers an aggregation-prone domain of YopT, presumably corresponding to its MLD. Thus, SycO, SycE and most likely SycT mask, inside the bacterium, a domain needed for proper localization of their cognate effector in the host cell. We propose that covering an MLD might be an essential function of T3S effector chaperones.

The EMBO Journal (2006) 25, 3223–3233. doi:10.1038/sj.emboj.7601202; Published online 22 June 2006

Subject Categories: microbiology & pathogens

Keywords: effectors; targeting; translocation; type III secretion; Yops

Introduction

Type III secretion (T3S) allows pathogenic and symbiotic Gram-negative bacteria to deliver bacterial effector proteins straight into the cytosol of an eukaryotic host cell (Cornelis and Wolf-Watz, 1997). Translocation of the effectors is a very rapid process (Schlumberger *et al.*, 2005) triggered by host cell contact (Pettersson *et al.*, 1996) and achieved in one step

by a sophisticated nanomachine called the injectisome or needle complex (Kubori *et al.*, 1998; Mueller *et al.*, 2005). The assembly and operation of the injectisome involves small (12–18 kDa) chaperones that remain in the bacterial cytosol (Wattiau and Cornelis, 1993; Menard *et al.*, 1994; Feldman and Cornelis, 2003; Parsot *et al.*, 2003; Ghosh, 2004). These chaperones represent a special family of chaperones found only in T3S systems. Some of these chaperones are involved in the assembly of the injectisome (class III) or the translocation pore (class II), whereas others are ancillary to effectors (class I). Class-I chaperones are acidic (pI: 4–5), usually dimeric, proteins, which bind their cognate effector within their first 100 amino acids, just downstream of the short N-terminal secretion signal. They are often, but not always, encoded next to the gene encoding their partner protein. They present a low sequence similarity, but their structure is quite well conserved. Several three-dimensional structures of T3S chaperones have been solved during the last years, showing that they all adopt a similar fold consisting of five β -strands and three α -helices (Birtalan and Ghosh, 2001; Luo *et al.*, 2001; Stebbins and Galan, 2001; Evdokimov *et al.*, 2002; Trame and McKay, 2003; Phan *et al.*, 2004; van Eerde *et al.*, 2004; Buttner *et al.*, 2005; Locher *et al.*, 2005). Structures of chaperones in complex with their effector proteins have shown that the chaperone-binding domain (CBD) of effectors wraps around the homodimers in an extended, horseshoe-like conformation with some secondary structure organization in α -helical structures (Stebbins and Galan, 2001; Birtalan *et al.*, 2002; Phan *et al.*, 2004). Chaperones are removed from effectors, before their translocation into host cells, by the ATPase that is part of the injectisome (Woestyn *et al.*, 1994; Akeda and Galan, 2005). Although some chaperones of T3S effectors have been intensively studied and characterized, their essential function remains a matter of controversy. Some studies suggest that chaperones could be three-dimensional targeting factors or even that they play a role in the setting of a secretion hierarchy (Boyd *et al.*, 2000; Birtalan *et al.*, 2002). Other observations suggest that they are required for the storage of effectors in the bacterial cytosol before secretion (Page *et al.*, 2002) and even that they prevent folding during storage (Stebbins and Galan, 2001; Page *et al.*, 2002).

The Ysc (for Yop Secretion) T3S system allows pathogenic *Yersinia* (*Y. pestis*, *Y. pseudotuberculosis* and *Y. enterocolitica*) to escape the innate immune defenses. It is encoded on a 70-kb virulence plasmid, called pYV in *Y. enterocolitica*, and it injects six effector proteins, called Yops, into the cytosol of macrophages. YopH, YopE, YopT and YopO disturb the cytoskeleton dynamics and inhibit phagocytosis (Cornelis, 2002). Three of these Yops, namely YopE, YopH and YopT, have a dedicated chaperone called SycE (Wattiau and Cornelis, 1993; Birtalan and Ghosh, 2001), SycH (Wattiau *et al.*, 1994; Phan *et al.*, 2004) and SycT (Iriarte and Cornelis, 1998; Buttner *et al.*, 2005; Locher *et al.*, 2005), respectively. No chaperone has been described so far for YopO (called YpkA in *Y. pestis* and

*Corresponding author. Biozentrum, Klingelbergstrasse 50, 4056 Basel, Switzerland. Tel.: +41 61 267 2110; Fax: +41 61 267 2118; E-mail: guy.cornelis@unibas.ch

³Present address: Imperial College London, Centre for Molecular Microbiology and Infection, Flowers Building, Armstrong Road, London SW7 2AZ, UK

⁴Present address: Department of Biological Sciences, University of Alberta, Edmonton, Canada

Received: 11 January 2006; accepted: 29 May 2006; published online: 22 June 2006

Y. pseudotuberculosis), a broad-spectrum serine threonine kinase (Galyov *et al*, 1993) that becomes activated upon contact with actin (Juris *et al*, 2000). It is localized to the plasma membrane of the target cell (Hakansson *et al*, 1996; Dukuzumuremyi *et al*, 2000) and it interacts with Rho and Rac (Barz *et al*, 2000) but its physiological target is still unknown. The gene encoding YopO (YpkA) is part of an operon encoding also the effector YopP (Cornelis *et al*, 1987; Galyov *et al*, 1994; Iriarte and Cornelis, 1999) (YopJ in *Y. pestis* and *Y. pseudotuberculosis*), which interrupts pro-inflammatory signalling cascades and leads macrophages to apoptosis (Mills *et al*, 1997; Zhou *et al*, 2005). The first open reading frame of the operon, *orf155*, encodes a protein that presents all the characteristics of a T3S chaperone (Iriarte and Cornelis, 1999), but its role could not be demonstrated so far (Trulzsch *et al*, 2003).

Here, we demonstrate that *orf155* indeed encodes a chaperone for YopO and we called it SycO. We show that SycO prevents the intrabacterial aggregation of YopO by covering a membrane localization domain (MLD). As many T3S effectors, which have a chaperone, have also been shown to be membrane associated, these observations suggest that covering a MLD could be the primary function of the T3S effector chaperones.

Results

orf155 encodes a protein that has the characteristics of chaperones of effector proteins

In the three pathogenic *Yersinia* species, the operon encoding YopO (YpkA) and YopP (YopJ) contains a small open reading frame (*orf*) encoding a 142- (*Y. pestis* KIM) to 155- (*Y. enterocolitica* E40) residue acidic protein (Galyov *et al*, 1994; Iriarte and Cornelis, 1999) (Supplementary Figure S1). Upstream of residue 133, the three proteins are 98% identical. Programs searching sequence similarities and fold recognition revealed low but significant similarities between Orf155 and various T3S class-I chaperones (Supplementary Figure S1). Based on this, a three-dimensional structure, very similar to that of class-I chaperones, could be derived (Supplementary Figure S1 and Supplementary data 1).

orf155 encodes SycO, the chaperone of YopO

The entire *orf155* was deleted from the pYV plasmid of *Y. enterocolitica* E40(pYV40) giving E40(pML4001) (Δ *orf155* mutant). Yop secretion was triggered by chelating Ca²⁺ ions (Cornelis *et al*, 1987). Under standard induction conditions (4 h), all the Yops were detected in the culture supernatant (not shown). However, when the time allowed for secretion was reduced, there was less YopO (YpkA) in the culture supernatant of mutant bacteria than in the culture supernatant of wild-type (wt) bacteria (Figure 1A). No other Yop, including YopP, encoded downstream of *orf155* and *yopO* was affected, indicating that the mutation was non-polar (data not shown). As known for the other T3S chaperones, SycO itself was not secreted (data not shown).

We then monitored translocation of YopO into macrophages during the infection of a cell culture, using the adenylate cyclase (Cya) reporter method (Sory and Cornelis, 1994). We introduced plasmid pCD10, encoding the first 143 amino acids of YopO fused to Cya, into wt *Y. enterocolitica* E40 as well as into the Δ *orf155* mutant and various control strains

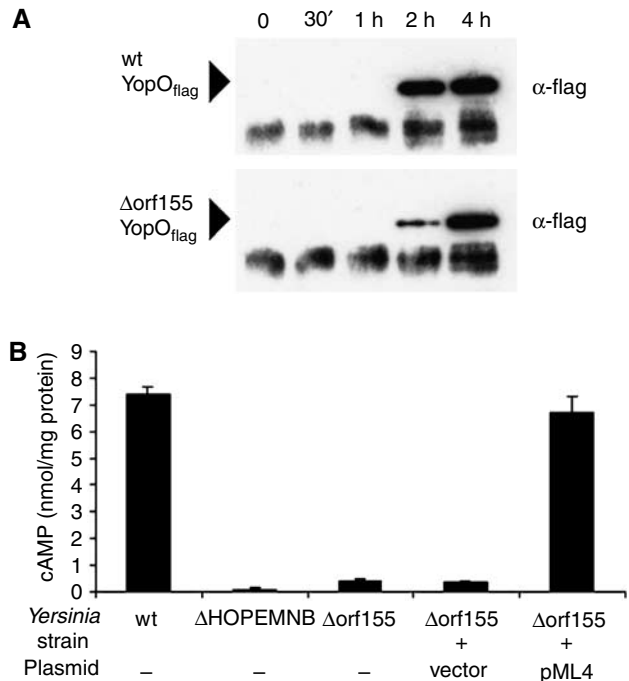

Figure 1 The Δ *orf155* mutant is impaired in secretion and translocation of YopO. (A) Plasmid pISO56 encoding YopO_{flag} was introduced into wt E40(pYV40) bacteria and into Δ *orf155* mutant bacteria E40(pML4001). Yop secretion was induced by incubating at 37°C in a medium deprived of Ca²⁺ ions. Samples of the supernatant were taken at different time points after shift of the culture from 28 to 37°C. YopO_{flag} was detected by immunoblot. Top, wt; bottom, Δ *orf155* mutant. The lower background band shows that an equivalent amount of supernatant has been loaded in each lane. (B) Translocation of the YopO-Cya reporter into infected J774 macrophages. Plasmid pCD10 encoding YopO₁₄₃-Cya was introduced into E40(pYV40) wt bacteria, into Δ *orf155* knockout bacteria E40(pML4001) and into the translocator-deficient E40(pCNK4008) (called Δ HOPEMNB). The low-copy plasmid pML4 encoding *sycO* complemented the Δ *orf155* mutation, whereas the vector alone did not. Cellular levels of cAMP were assayed after infection.

and we infected cultured J774 macrophages. Cells that were infected by wt bacteria accumulated cAMP. In contrast, cells infected with the Δ *orf155* mutant did not produce more cAMP than cells infected with translocation-deficient bacteria Δ HOPEMNB (Figure 1B). Complementation of Δ *orf155* mutant bacteria with plasmid pML4 restored translocation of YopO up to the wt level (Figure 1B). These experiments showed that the product of *orf155* is required for translocation of YopO and hence, given its similarity to Syc chaperones, it was tentatively called SycO.

To ascertain that translocation of YopP was not dependent on SycO, we monitored apoptosis of macrophages infected by wt *Y. enterocolitica* E40(pYV40) and by Δ *orf155* *Y. enterocolitica* E40(pML4001). No difference could be seen between the two infected cultures (data not shown), confirming that SycO is not the chaperone of YopP, as shown earlier (Trulzsch *et al*, 2003).

SycO binds to residues 20–77 of YopO

To confirm that SycO is the chaperone of YopO, we tested whether the two proteins interact and how. The *sycO-yopO* genes were coexpressed in *Escherichia coli* BL21 and SycO was co-purified with YopO_{his} (data not shown) suggesting

that the two proteins form a complex when synthesized together in *E. coli*. To ascertain this observation, a sample of co-purified proteins was loaded on an analytical gel filtration column. YopO and SycO eluted together around fraction 9 (Figure 2A), whereas purified SycO loaded alone eluted around fraction 14 (Figure 2B). To localize the CBD of YopO, three different YopO-Cya hybrid proteins were produced in the multi-effector knockout *Y. enterocolitica* ΔHOPEMT together with GST-SycO. YopO₁₄₃-Cya and YopO₇₇-Cya co-purified with SycO on glutathione Sepharose, whereas YopE₂₀-Cya did not (not shown). These experiments led to

the conclusion that the CBD of SycO is localized within the 77 N-terminal residues of YopO. As SycE binds to residues 15–75 of YopE (Woestyn *et al*, 1996; Birtalan *et al*, 2002) and SycH binds to residues 20–70 of YopH (Woestyn *et al*, 1996), we made the assumption that SycO could also bind immediately after the secretion signal of YopO. To test this hypothesis, we constructed a GST-YopO hybrid, a variant where residues 20–77 of YopO were deleted (GST-YopO_{Δ22–77}) and a hybrid containing only residues 20–77 of YopO (GST-YopO_{20–77}). All three hybrid proteins were expressed in parallel in *Y. enterocolitica* E40. SycO was pulled down together with GST-YopO and with GST-YopO_{20–77} but not with GST-YopO_{Δ20–77} (Figure 2C). This indicated that residues 20–77 of YopO include the core of the CBD.

We then investigated the stoichiometry of the YopO–SycO complex and observed that SycO dimerizes and binds YopO as a dimer (Supplementary data 2), as known for the other class-I chaperones.

We finally compared the CBD of YopO to that of YopE *in silico* and found that they share a similar secondary structure, meaning that the YopO CBD is likely to wrap around the dimer of SycO as the YopE CBD wraps around the dimer of SycE (Supplementary data 3).

Binding of SycO to YopO does not prevent folding of the whole protein

It has been proposed that class-I chaperones could keep the effectors in an unfolded secretion competent state (Stebbins and Galan, 2001). To test this hypothesis for YopO, we monitored the autophosphorylating activity of the purified kinase (Galyov *et al*, 1993), with and without the CBD. As YopO was poorly soluble without its chaperone but was more soluble as a GST fusion or without the CBD, we compared the kinase activity of GST-YopO to that of YopO_{Δ20–77} and YopO-(SycO)₂. As a negative control, we engineered an inactive GST-YopO hybrid with the D267A substitution in the catalytic site (Juris *et al*, 2000). As expected, the kinase activity was dependent on the presence of actin (Juris *et al*, 2000) (Figure 3). Importantly, YopO_{Δ20–77} was at least as active as GST-YopO (Figure 3), showing that the CBD is not needed for the catalytic activity of YopO. In addition, the YopO-(SycO)₂ complex turned out to be as active as GST-YopO, showing that SycO binding does not prevent folding of the whole protein. Interestingly, SycO itself was phosphorylated. This has no physiological relevance, as chaperones are not translocated into host cells (Wattiau *et al*, 1994), but it confirms the broad spectrum activity of YopO (Juris *et al*, 2000).

YopO_{ΔCBD} can be exported by the Ysc T3S system and translocated into host cells

To further investigate the role of SycO, we removed the CBD within YopO and first tested the consequences in terms of secretion triggered by Ca²⁺ chelation. We compared secretion of YopO_{flag} and YopO_{Δ20–77flag} after 3 h of incubation at 37°C in the presence and absence of SycO. As expected, the absence of SycO had a negative effect on secretion of YopO but not on secretion of YopO_{Δ20–77}. Unexpectedly, there was more YopO_{Δ20–77flag} than YopO_{flag} in the supernatant and in the lysate of wt bacteria (Figure 4A). However, it has been shown in *Salmonella* that the chaperone prevents the effectors SptP and SopE to be secreted by the flagellum rather than by the injectisome (Lee and Galan, 2004). To ensure that

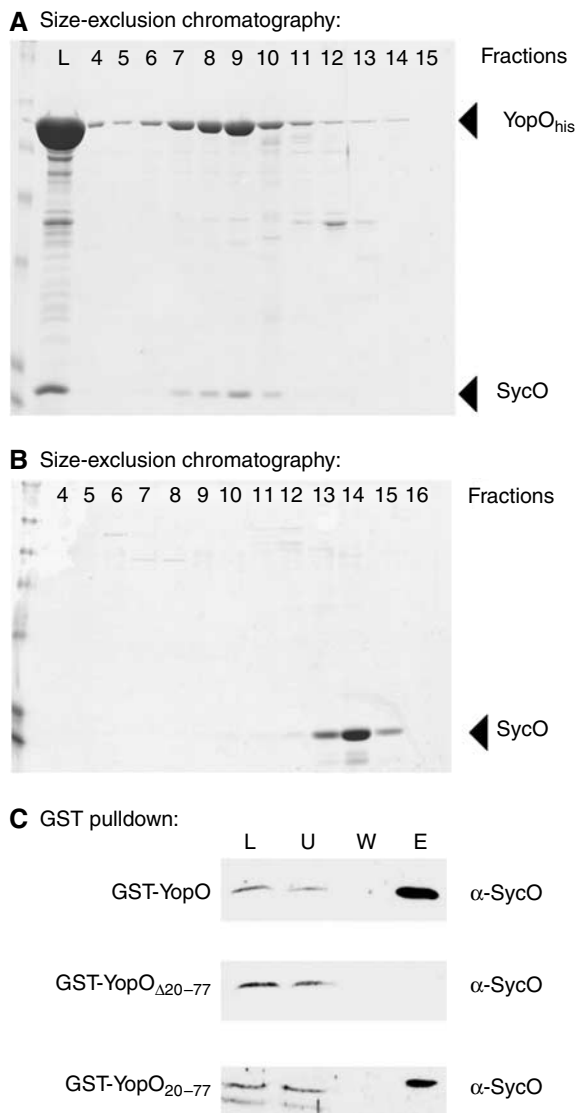

Figure 2 Characterization of the YopO–SycO interaction. (A) YopO_{his} and SycO encoded by pML9 were synthesized in *E. coli* BL21 and co-purified on Ni²⁺ Sepharose. The purified complex (L) was loaded onto a Superdex™ 200 gel filtration column and the eluted fractions (4–15) were analyzed by Coomassie-stained SDS-PAGE. YopO_{his} and SycO eluted together around fraction 9. (B) Purified SycO protein (see Supplementary data 4), loaded on the same column, eluted around fraction 14. (C) Plasmids pML10, pML11 and pML17 encoding GST-YopO, GST-YopO_{Δ20–77} and GST-YopO_{20–77}, respectively, were introduced into *Y. enterocolitica* E40 wt producing SycO from the pYV40 plasmid. GST hybrid proteins were pulled down from crude extracts, analyzed by SDS-PAGE and the presence of SycO was monitored by immunoblotting. L, lysate; U, unbound; W, wash; E, eluted.

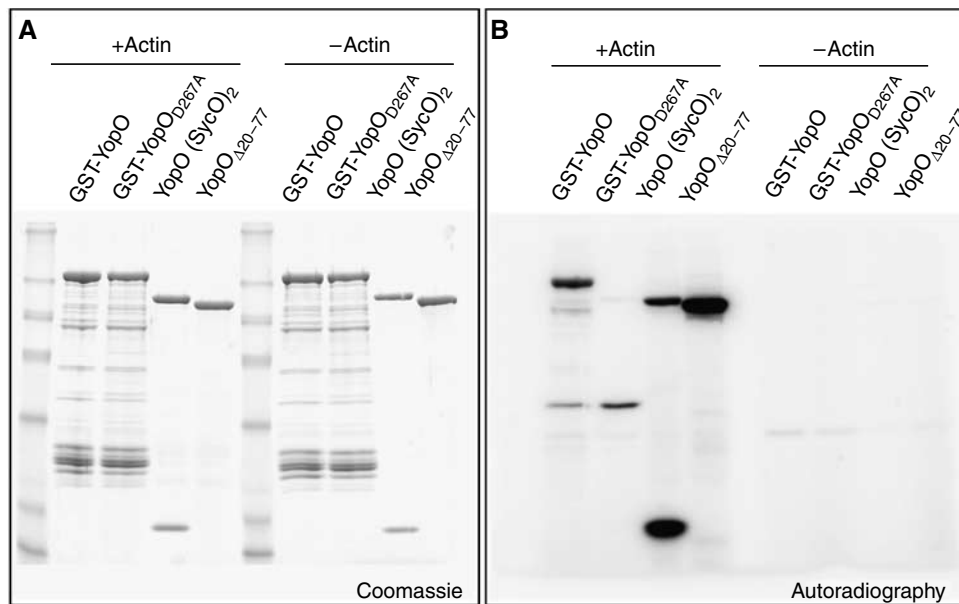

Figure 3 Binding of SycO to YopO does not prevent the catalytic activity of YopO. GST-YopO, GST-YopO_{D267A}, YopO(SycO)₂ and YopO_{Δ20-77}, expressed in *E. coli* BL21 from plasmids pML10, pML12, pML10 + pML15 and pML11 respectively, were semipurified (Supplementary data 4), incubated with [γ -³²P]ATP in the presence and absence of actin and analyzed by Coomassie-stained SDS-PAGE (A) and autoradiography (B).

YopO_{Δ20-77}flag was indeed secreted by the injectisome, we monitored secretion by *Y. enterocolitica* W227(pSW2276) mutated in *yscN*, the gene encoding the ATPase energizing the T3S pathway. As shown in Figure 4A, the protein was not secreted, ruling out secretion by the flagellum. These results show that, in the absence of SycO, YopO is exported better without its CBD. This suggests that the CBD itself creates the need for SycO.

As a protein that is secreted is not necessarily delivered into cells (Figure 1), we removed the CBD from the YopO₁₄₃-Cya reporter protein and monitored translocation. Again, the observations on *in vitro* secretion and translocation were somewhat different. YopO_{143Δ20-77}-Cya was efficiently delivered into cells by ΔHOPEMT bacteria (Figure 4B) but not by wt bacteria (not shown). Thus, for translocation, we can conclude that the presence of the CBD and the chaperone facilitates the delivery of the effector but targeting can occur in their absence.

SycO prevents the intrabacterial aggregation of YopO mediated by the CBD

In order to understand why the presence of the CBD reduces the amount of YopO secreted *in vitro*, we compared the solubility of YopO and YopO_{Δ20-77} in *E. coli*. In the absence of SycO, YopO_{Δ20-77}his was abundant and mostly soluble, whereas YopO_{his} was present in very small amounts and exclusively in the insoluble fraction (Figure 5A). In the presence of SycO, there was more YopO_{his} than in the absence of SycO and most of it was soluble. This suggested that YopO is less soluble than YopO_{Δ20-77} and that SycO helps solubilizing YopO.

To confirm this observation, we purified YopO and YopO_{Δ20-77} and the YopO-(SycO)₂ complex using GST tags that were cleaved off at the last stage. Again, the yield of YopO was much lower than the yield of the two others (not shown). The three preparations as well as SycO alone were

analyzed by size-exclusion chromatography (Figure 5B). Whereas SycO, YopO-(SycO)₂ and YopO_{Δ20-77} were eluted as expected from their size, YopO appeared in the void volume, indicating that it was aggregated. Thus, the CBD creates the need for SycO because it drastically reduces the intrabacterial solubility of YopO.

The SycO-binding domain is a cell membrane targeting domain

The previous experiments demonstrated that SycO is required because of the presence of residues 20–77 in YopO and that these residues are not involved in the catalytic activity. As YopO is targeted to the membrane of the host cell (Hakansson *et al*, 1996; Dukuzumuremyi *et al*, 2000), we tested whether the residues 20–77 would not act as an MLD. To investigate this possibility, the 3' end of different *yopO* constructs was fused to the EGFP gene and HEK293T cells were transfected with the recombinant plasmids. Whereas EGFP was distributed in the cytosol and the nucleus, YopO-EGFP was preferentially localized at the plasma membrane, as expected. Furthermore, cells transfected with plasmid pML1, encoding YopO-EGFP, became rounded (Figure 6), indicating that the YopO-EGFP hybrid protein had kept an activity in the cell. A YopO_{D267A}-EGFP catalytic mutant also localized to the membrane. This showed that the catalytic activity is not required for membrane localization. In contrast, YopO_{Δ20-77}-EGFP did not localize to membranes and cells transfected with pML2, encoding YopO_{Δ20-77}-EGFP, did not round up. We concluded that the CBD was required for the membrane targeting and that this membrane localization was necessary for YopO-EGFP activity (Figure 6). To delineate more accurately the MLD, we fused residues 20–80 and 20–90 of YopO to EGFP and monitored the localization of the hybrid. Residues 20–90, but not 20–80, were sufficient to target EGFP to the membrane. There is thus a good correlation between the CBD (20–77) and the MLD (20–90).

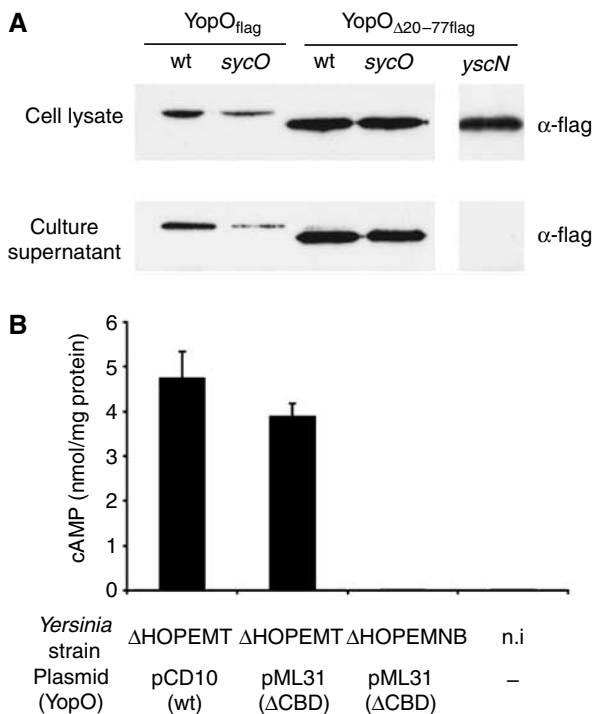

Figure 4 YopO_{Δ20-77} can be secreted and delivered into host cells. (A) Plasmid pISO56 encoding YopO_{flag} or pML16 encoding YopO_{Δ20-77flag} was introduced into wt *Y. enterocolitica* E40(pYV40), ΔSycO *Y. enterocolitica* E40(pML4001) and *yscN* *Y. enterocolitica* E40(pSW2276). Yop secretion was triggered by Ca²⁺ chelation for 3 h and the supernatants were analyzed by Western blotting. (B) Translocation of the YopO_{143Δ20-77}-Cya reporter into infected J774 macrophages. Plasmid pML31 encoding YopO_{143Δ20-77}-Cya (ΔCBD) was introduced into the multi-effector knockout mutant E40(pIML421) (called ΔHOPEMT) and into the translocator-deficient E40(pCNK4008) (called ΔHOPEMNB). Plasmid pCD10 encodes YopO₁₄₃-Cya (wt). Cellular cAMP levels were assayed after infection.

The CBDs of YopE and YopT are also aggregation-prone MLDs

The experiments described above demonstrate that SycO is required to mask the aggregation-prone MLD of YopO inside the bacterium. We wondered whether this hypothesis could apply to other class-I chaperones.

Like the CBD of YopO, residues 50–77 of YopE create the need for SycE (Boyd *et al.*, 2000). Even more, residues 54–75 have been shown to represent an MLD for YopE (Krall *et al.*, 2004). As shown in Figure 7A, YopE₉₀-EGFP expressed in HEK293T cells showed a peri-nuclear localization including the *cis*-Golgi. This does not mean that when YopE is injected by *Yersinia*, it would be associated to the Golgi, but it confirms that the CBD confers some membrane targeting properties to YopE, as shown earlier (Krall *et al.*, 2004). It is thus likely that the CBD causes intrabacterial insolubility. We thus tested the intrabacterial solubility of YopE in the presence and absence of SycE. As shown in Figure 7D, SycE clearly increased the solubility of YopE. This result is in perfect agreement with previous data from Birtalan *et al.* (2002) showing that binding of SycE rescues purified YopE from aggregation.

As YopT, like YopE, targets Rho GTPases (Zumbihl *et al.*, 1999; Black and Bliska, 2000; Von Pawel-Rammingen *et al.*, 2000; Shao *et al.*, 2002) and also associates with host cell

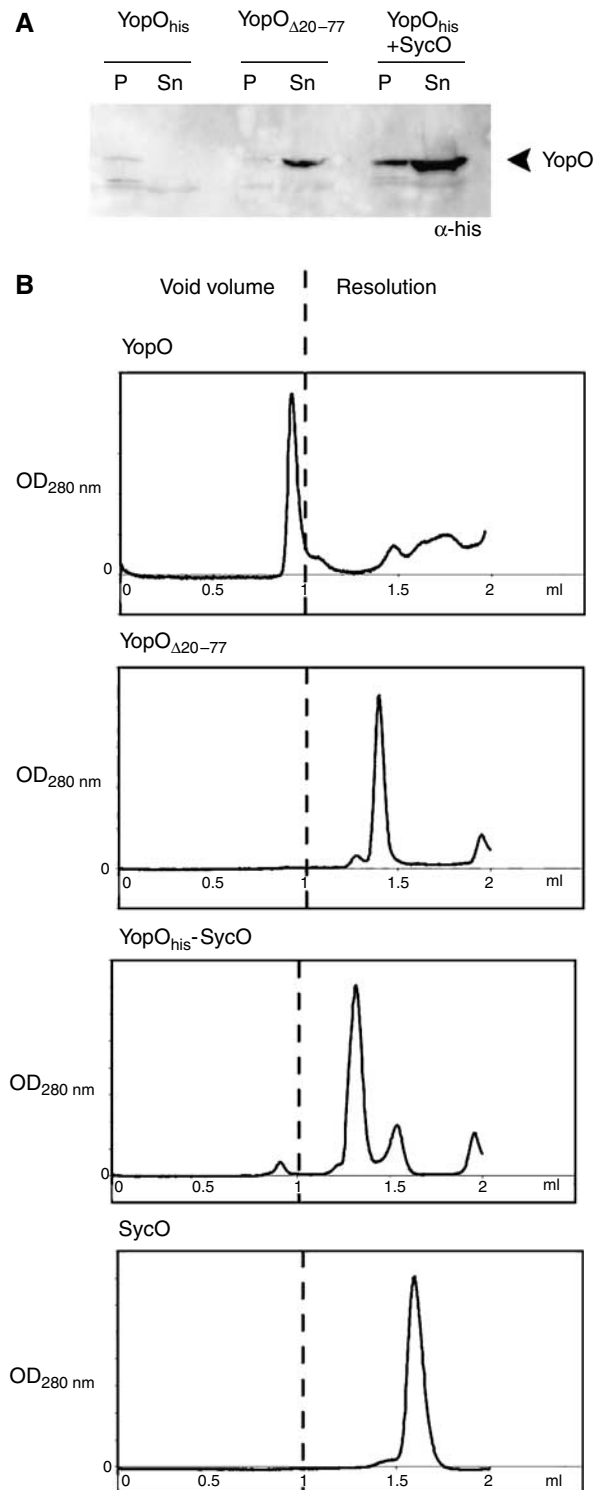

Figure 5 The CBD causes aggregation of YopO. (A) YopO_{his}, YopO_{Δ20-77his} and YopO_{his} + SycO were overexpressed in *E. coli* BL21 from plasmids pML7, pML8 and pML9, respectively. The cleared lysates (see Materials and methods) were centrifuged at 100 000 g to separate soluble (Sn) from insoluble (P) proteins and analyzed by Western blotting. (B) GST-YopO, GST-YopO_{Δ20-77} and GST-YopO(SycO)₂ were synthesized in *E. coli* and purified as described in Supplementary data 4. After removal of the GST tag, the proteins were analyzed on a Superdex™ 200 gel exclusion chromatography. Purified SycO (see Supplementary data 4) was analyzed in parallel.

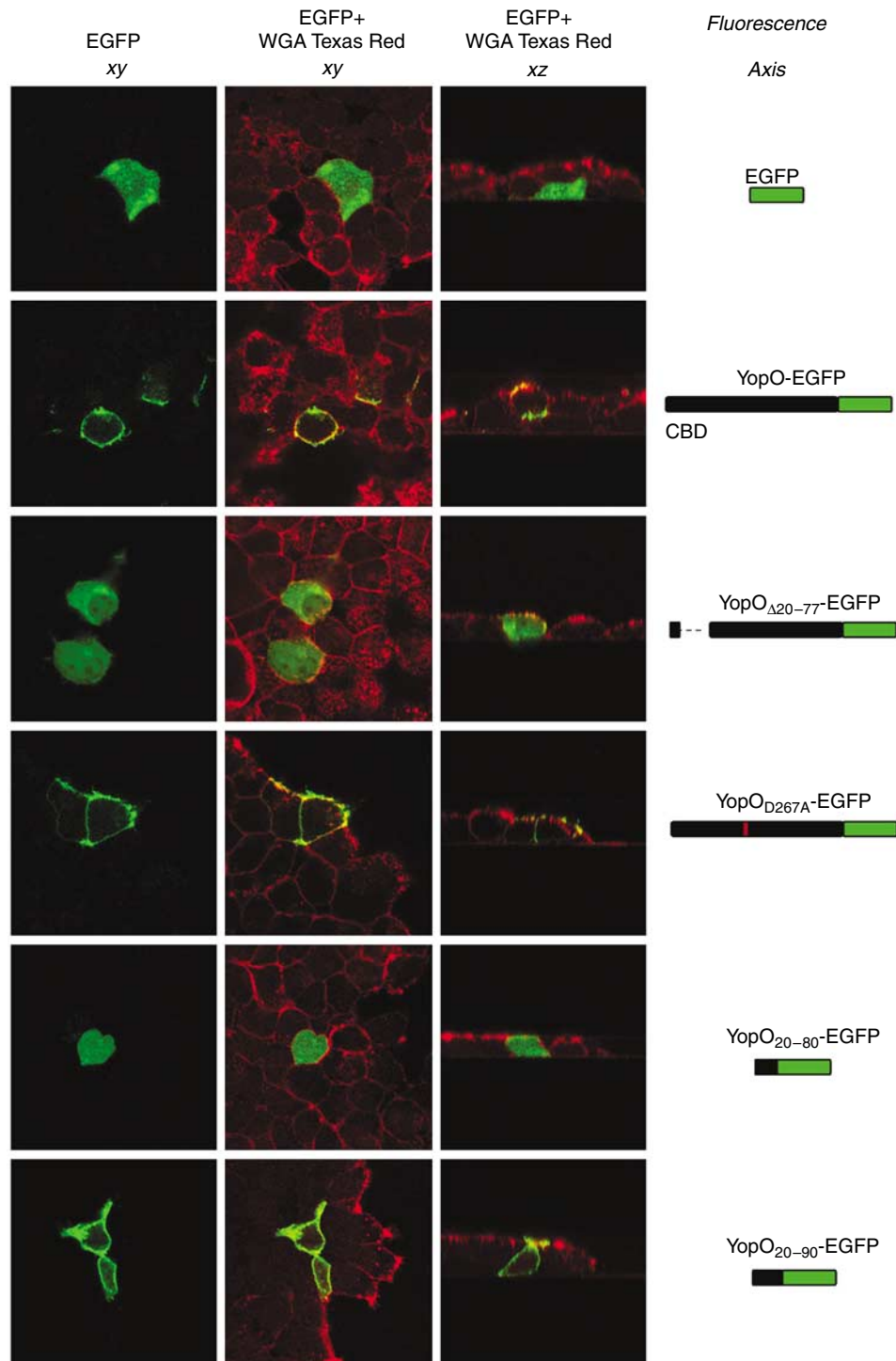

Figure 6 The CBD of YopO is an MLD. The different constructs drawn on the right panel were transfected in HEK293T cells. Cells were grown for 24 h, stained with Texas Red-conjugated wheat germ agglutinin, fixed and analyzed by confocal microscopy. The constructs were encoded by pML1 (YopO-EGFP), pML2 (YopO Δ ₂₀₋₇₇-EGFP), pML3 (YopO_{D267A}-EGFP), pML26 (YopO₂₀₋₈₀-EGFP) and pML27 (YopO₂₀₋₉₀-EGFP).

membranes (Aepfelbacher *et al*, 2003), we would predict that the CBD of YopT is also an MLD. The CBD of YopT has been localized, by limited proteolysis, between residues 52 and 139 (Buttner *et al*, 2005). In order to test whether this CBD would also correspond to the MLD, we fused residues 1–124 of YopT to EGFP and expressed the hybrid in HEK293T cells. YopT₁₂₄-EGFP presented a punctuated distribution evoking either lysosomal association or aggregation (Figure 7B and

C). Using LAMP1 as a lysosomal marker, we observed that YopT₁₂₄-EGFP did not colocalize with lysosomes, suggesting that YopT₁₂₄ was causing the aggregation of EGFP. We then tested whether the SycT chaperone would not influence the intrabacterial solubility of YopT. As shown in Figure 7D, this was indeed the case.

We fused the first 90 amino acids of YopH to EGFP, but no specific distribution was observed. EGFP was homo-

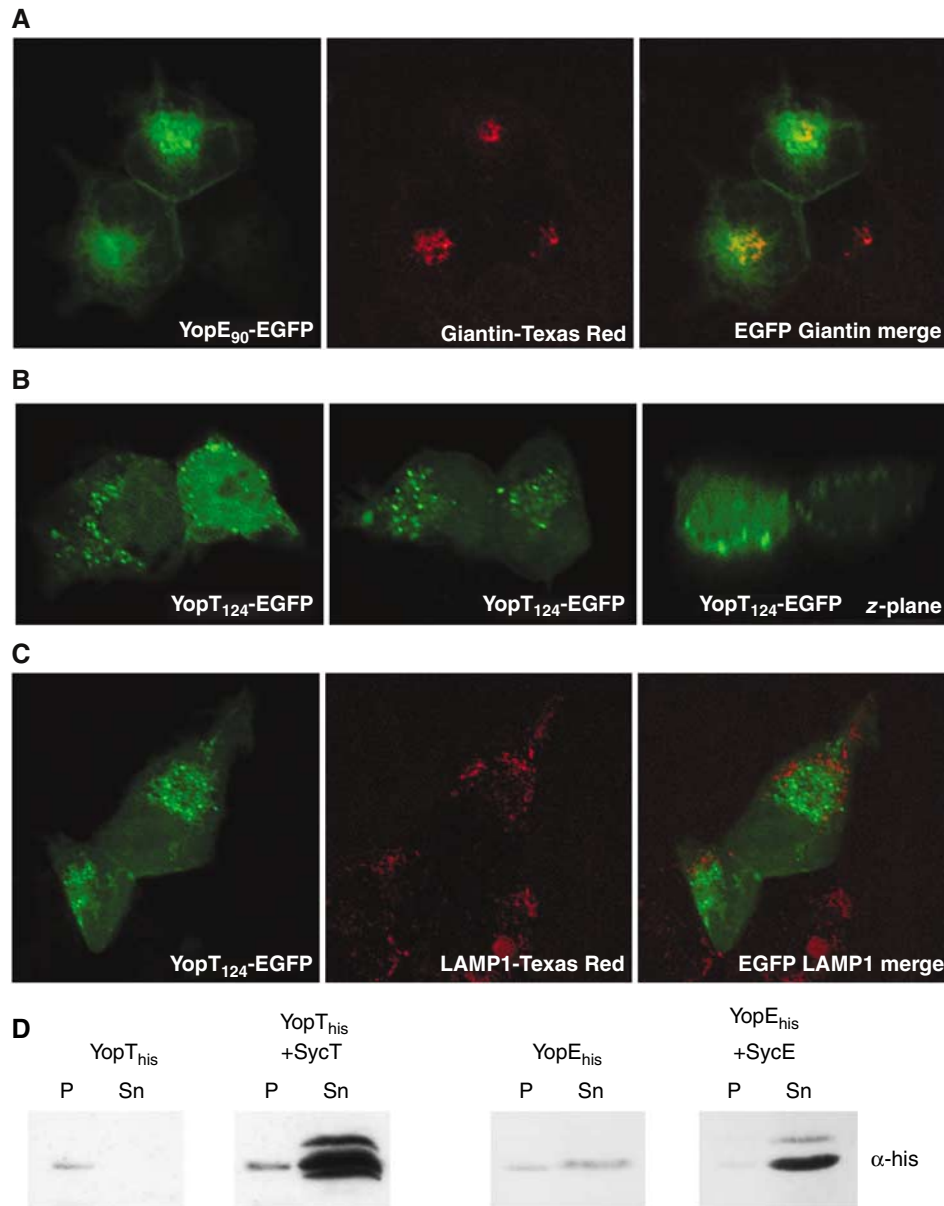

Figure 7 Role of the CBD of YopE and YopT. The fusions YopE₉₀-EGFP (A) and YopT₁₂₄-EGFP (B, C) were expressed in HEK293T cells after transfection of plasmids pSAM10 and pSAM12, respectively. Cells were grown 24 h, fixed, permeabilized and immunolabelled with α -Giantin (A) or α -LAMP1 (C). Pictures were acquired by confocal microscopy. (D) YopE_{his} and YopT_{his} encoded by pML33 and pML34 were expressed in *E. coli* BL21 with or without SycE or SycT encoded by plasmids pSAM13 or pSAM15, respectively. The cleared lysates (see Materials and methods) were centrifuged at 100 000 g to separate soluble (Sn) from insoluble (P) proteins and analyzed by Western blotting.

geneously distributed in the whole cell (data not shown). In addition, there was no clear difference in the solubility of YopH in the presence or absence of SycH.

Finally, we analyzed the cellular localization of YopP, for which no chaperone was described. The hybrid YopP-EGFP transfected into HEK293T cells appeared uniformly distributed to the cytosol (not shown).

In conclusion, we suggest that SycO, SycE and SycT cover an aggregation-prone MLD.

Discussion

In *Yersinia*, the chaperones of effector proteins are SycE (Wattiau and Cornelis, 1993; Birtalan and Ghosh, 2001), SycH (Wattiau *et al*, 1994; Phan *et al*, 2004) and SycT

(Iriarte and Cornelis, 1998; Buttner *et al*, 2005; Locher *et al*, 2005). SycO described in this paper shares all the properties of these Syc proteins and clearly represents a new member of this group. However, its phenotype is somewhat more subtle and this explains why it is discovered more than 10 years later than the others. At first sight, SycO does not appear to be required for *in vitro* secretion of YopO but it is required for translocation of YopO into cells. If chaperones are necessary for export of effector molecules that are stored in the cytoplasm, but not for export of those synthesized while the secretion apparatus is active, as demonstrated by Parsot and co-workers (Page *et al*, 2002) for Spa15, then our results indicate that translocation of YopO into cells is essentially post-translational. In contrast, *in vitro* secretion of YopO, induced by Ca²⁺ chelation, could be also co-translational.

Having shown that SycO is a new member of the group of *Yersinia* effector chaperones, we tried to address its function, taking into consideration the different functions already proposed for the proteins of this group. We observed that binding of SycO to YopO does not prevent the activity of the kinase domain of YopO, implying that the catalytic domain (residues 160–400) and the actin-binding domain (residues 709–729) (Juris *et al*, 2000) are folded. Thus, SycO does not maintain YopO in a completely unfolded secretion-competent state. This observation is in perfect agreement with the observation of Birtalan *et al* (2002) that SycE does not prevent the GAP activity of YopE and with the observation of Akeda and Galan (2005) that SicP does not prevent the tyrosine phosphatase activity of SptP, revising an earlier interpretation of Stebbins and Galan (2001). For SycO, we thus rule out that its function is to maintain YopO in an unfolded state, which also implies that the injectisome can unfold its substrates during export, as was clearly demonstrated for SptP by Akeda and Galan (2005).

However, we observed that SycO keeps YopO soluble in the cytosol of *Yersinia* before export and that it is precisely the SycO-binding domain that makes YopO insoluble. Thus, the presence of the CBD creates the need for the chaperone. As pointed out by Birtalan *et al* (2002), it is unlikely that chaperones exist simply to mask an aggregation-prone effector region whose only function is chaperone binding. We thus looked for a function of this aggregation-prone domain and we found that it was an MLD. A function of SycO is thus to hide the aggregation-prone MLD of YopO while YopO is in the bacterium.

Would this new function apply to other class-I chaperones? Previous data from Krall *et al* (2004) and data presented here show that it also applies to YopE. It probably also applies to YopT because the CBD causes aggregation of transfected hybrid proteins in the host cell. However, it should still be demonstrated that this domain targets YopT to the membrane when YopT is injected rather than transfected. We also tried to extend the hypothesis to YopH, which targets focal adhesions (Persson *et al*, 1999) and another membrane-associated complex (Black *et al*, 2000). We did not observe any membrane localization of transfected YopH₉₀-EGFP and any change in the intrabacterial solubility of YopH with or without SycH. However, for YopH, the situation could be more complex as the CBD already partially overlaps with the phospho-tyrosine recognition domain (Montagna *et al*, 2001). Moreover, different domains of YopH including its CBD have been shown to interact with the Fyn binding protein in macrophages (Yuan *et al*, 2005). Thus, the CBD of YopH might not be a membrane targeting domain, it is nevertheless an intracellular targeting domain. In good agreement with our hypothesis about class-I chaperones, YopM (Benabdillah *et al*, 2004) and YopP, which do not have a chaperone, do not localize to membranes. In *Yersinia*, there is thus a correlation between the presence of a chaperone and an activity of the effector at the membrane of the target cell.

Would this new hypothesis about effector chaperones and MLDs also apply to effectors of other T3S systems? The hypothesis predicts that the effectors that have a chaperone would act at the membrane of the host cell. Among the best-characterized class-I chaperones, we find SicP (Fu and Galan, 1998) and SigE (Darwin *et al*, 2001) from *Salmonella enterica*, CesT from enteropathogenic *E. coli* (Elliott *et al*, 1999) and Spa15 from *Shigella* (Page *et al*, 2002). SptP, the

partner of SicP, is a GAP for Rho (Fu and Galan, 1999) and has been shown to localize at the plasma membrane of infected cells (Cain *et al*, 2004); SigD/SopB, the partner of SigE, is an inositol phosphatase (Norris *et al*, 1998), which was shown to be membrane-associated (Marcus *et al*, 2002; Cain *et al*, 2004); Tir, the partner of CesT, is the membrane-associated intimin receptor (Kenny *et al*, 1997); and finally, Spa15 is, among others, the chaperone of IpaA, which contributes to *Shigella* entry by binding the focal adhesion protein vinculin (Tran Van Nhieu *et al*, 2000). Thus, all these effectors have a chaperone of the SycE family, and are targeted to the membrane. Furthermore, the *Salmonella* effectors SopE, SopE2 and SipA, which all share the InvB chaperone (Bronstein *et al*, 2000; Ehrbar *et al*, 2003), have also been shown to localize at the membrane of infected cells (Cain *et al*, 2004).

Does this new function for class-I chaperones exclude any targeting function? Certainly not, as the CBD and SycO are required for efficient delivery of YopO into cells by wt *Yersinia* bacteria. This situation is reminiscent of YopE. Indeed, YopE deprived of its CBD cannot be delivered by wt bacteria but it can be delivered by mutant bacteria deprived of all the other effectors (Boyd *et al*, 2000). Chaperones bound to the effector thus improve targeting to the secretion apparatus, either by acting as a three-dimensional secretion signal, as suggested for SycE (Birtalan *et al*, 2002), or simply by presenting the secretion signal. The presence of the chaperone could also favor the interaction with the ATPase, and so facilitate the unfolding of the effector (Akeda and Galan, 2005). Our data do not allow to discriminate between these hypotheses.

We thus suggest that the class-I chaperones have two functions: (i) cover an aggregation-prone MLD and (ii) facilitate export. Which one of these two functions would have appeared first? As some effectors seem not to have a chaperone (YopM and YopP in *Yersinia*), we would speculate that the primary function of effector chaperones is to cover an MLD and that targeting of effector chaperone complexes has been gradually optimized by evolution. In support of this view, YopO and YopE deprived of their CBD can be translocated by multi-effector knockout mutant bacteria. CBDs and chaperones thus evolved to serve two different essential functions, one inside the bacterium and one inside the host cell.

Materials and methods

Bacterial strains, plasmids and genetic constructions

Y. enterocolitica E40 (Sory and Cornelis, 1994) and W22703 (Cornelis *et al*, 1986), both from serotype 0:9, were used for T3S experiments. *E. coli* BL21 was used for protein expression and *E. coli* Top10 was used for plasmid amplification and cloning. Plasmids are listed in Table I. Oligonucleotides labelled with * in Table I were used to delete or mutate domains by inverse polymerase chain reaction, using the *Pfu* turbo polymerase (Stratagene). Every construct was sequenced using 3100-Avant genetic analyzer (ABI Prism). Oligonucleotides are listed in Supplementary Table S1.

Induction of type III secretion by low Ca²⁺

This was carried out as described earlier (Agrain *et al*, 2005).

Standard protein purification and analysis protocols

See Supplementary data 3.

Ultracentrifugation of crude extracts

YopO_{his}, YopO_{A20–77his} and SycO coexpressed with YopO_{his} were produced in *E. coli* BL21 from the pET22 vector using plasmids pML7, pML8 and pML9. Bacteria were grown overnight at 37°C,

Table I List of the plasmids used in this work

pYV derivatives			
Plasmids	Characteristics	References	
pYVe227	wt pYV plasmid from <i>Y. enterocolitica</i> W227	Cornelis <i>et al</i> (1986)	
pYV40	wt pYV plasmid from <i>Y. enterocolitica</i> E40	Sory <i>et al</i> (1995)	
pML4001	pYV40: <i>sycO</i>	This study	
pAB406	pYV40: <i>yopO</i> _{Δ65-558}	Mills <i>et al</i> (1997)	
pSW2276	pYV40: <i>yscN</i> _{Δ169-177}	Woestyn <i>et al</i> (1994)	
pIML421 (ΔHOPEMT)	pYV40: <i>yopH</i> _{Δ1-352} , <i>yopO</i> _{Δ65-558} , <i>yopP</i> ₂₃ , <i>yopE</i> ₂₁ , <i>yopM</i> ₂₃ , <i>yopT</i> ₁₃₅	Iriarte and Cornelis (1998)	
pCNK4008 (ΔHOPEMNB)	pYV40: <i>yopH</i> _{Δ1-352} , <i>yopO</i> _{Δ65-558} , <i>yopP</i> ₂₃ , <i>yopE</i> ₂₁ , <i>yopM</i> ₂₃ , <i>yopN</i> ₄₅ , <i>yopB</i> _{Δ89-217}	Neyt and Cornelis (1999)	
Clones			
Plasmids	Characteristics	Derivation and oligonucleotides used	References
pCD10	pTM100:: <i>yopO</i> _{143-cyaA'} (<i>sycE</i> promoter)	Unpublished	
pCD11	pTM100:: <i>yopO</i> _{77-cyaA'} (<i>sycE</i> promoter)	Unpublished	
pISO56	pBBR1 MCS2:: <i>yopO</i> _{flag} (<i>yopE</i> promoter)	Deletion of the <i>MunI/HindIII</i> fragment in pCD10	This study
pMAF60	pBBR1 MCS2:: <i>yopO</i> (<i>yopE</i> promoter)	Flag-tag insertion in pMAF60 *(3688/3710)	This study
pML1	pEGFP(N):: <i>yopO</i>	Cloning of <i>yopO</i> from pYOB2 3118/3119	This study
pML2	pEGFP(N):: <i>yopO</i> _{Δ20-77}	Cloning of <i>yopO</i> 3394/3395	This study
pML3	pEGFP(N):: <i>yopO</i> _{D267A}	Deletion from pML1 *(3396/3397)	This study
pML4	pBBR1 MCS2:: <i>sycO</i>	Mutation on pML1 *(3484/3485)	This study
pML7	pET22:: <i>yopO</i> _{his}	Cloning of <i>sycO</i> 3266/3271	This study
pML8	pET22:: <i>yopO</i> _{Δ20-77 his}	Cloning of <i>yopO</i> 3523/3525	This study
pML9	pET22:: <i>sycO-yopO</i> _{his}	Deletion from pML7 *(3396/3397)	This study
pML10	pGEX-6p-1:: <i>yopO</i>	Cloning of <i>sycO-yopO</i> 3524/3525	This study
pML11	pGEX-6p-1:: <i>yopO</i> _{Δ20-77}	Cloning of <i>yopO</i> 3698/3699	This study
pML12	pGEX-6p-1:: <i>yopO</i> _{D267A}	Deletion from pML10 *(3396/3397)	This study
pML13	pGEX-6p-1:: <i>yopO</i> ₂₀₀	Mutation on pML10 *(3484/3485)	This study
pML14	pBAD:: <i>sycO</i>	Cloning of <i>yopO</i> ₂₀₀ 3523/3908	This study
pML15	pCDF:: <i>sycO</i>	Cloning of <i>sycO</i> 3268/3250	This study
pML16	pBBR1 MCS2:: <i>yopO</i> _{Δ20-77 flag} (<i>yopE</i> promoter)	Cloning of <i>sycO</i> 3268/3271	This study
pML17	pGEX-6p-1:: <i>yopO</i> ₂₀₋₇₇	Deletion from pISO56*(3396/3397)	This study
pML18	pKS:: -250/ <i>sycO</i> / + 250	Cloning of <i>yopO</i> ₂₀₋₇₇ 4015/4028	This study
pML19	pKS:: -250/ <i>ΔsycO</i> / + 250	Cloning of -250/ <i>sycO</i> / + 250 3266/3267	This study
pML26	pEGFP(N):: <i>yopO</i> ₂₀₋₈₀	Deletion of <i>sycO</i> from pML18 *(3272/3273)	This study
pML27	pEGFP(N):: <i>yopO</i> ₂₀₋₉₀	Cloning of <i>yopO</i> ₂₀₋₈₀ 4134/4079	This study
pML31	pBBR1 MCS2:: <i>yopO</i> _{143Δ20-77-cyaA'} (<i>sycE</i> promoter)	Cloning of <i>yopO</i> ₂₀₋₉₀ 4134/4080	This study
pML33	pET22:: <i>yopE</i> _{his}	Deletion from pCD10*(3396/3397)	This study
pML34	pET22:: <i>yopT</i> _{his}	Cloning of <i>yopE</i> 4306/4309	This study
pMSLE20	pTM100:: <i>yopE</i> _{20-cyaA'}	Cloning of <i>yopT</i> 4307/4310	This study
pSAM10	pEGFP(N):: <i>yopE</i> ₁₋₉₀	Sory <i>et al</i> (1995)	This study
pSAM12	pEGFP(N):: <i>yopT</i> ₁₋₁₂₄	Cloning of <i>yopE</i> ₁₋₉₀ 4293/4294	This study
pSAM13	pCDF:: <i>sycE</i>	Cloning of <i>yopT</i> ₁₋₁₂₄ 4297/4298	This study
pSAM15	pCDF:: <i>sycT</i>	Cloning of <i>sycE</i> 4301/4302	This study
pYOB2	pCNR26:: <i>yopO</i> (<i>yopE</i> promoter)	Cloning of <i>sycT</i> 4299/4300	This study
		Cloning of <i>yopO</i> 471/473	This study
Cloning vectors			
Plasmids	Characteristics	References	
pBADmyc-his A	pBAD promoter, high copy	Invitrogen	
pBBR1-MCS2	Medium-low copy	Kovach <i>et al</i> (1995)	
pBluescript II KS (+)		Stratagene	
pCDF-Duet	T7 promoter	Novagen	
pCNR26	<i>yopE</i> promoter	Sarker <i>et al</i> (1998)	
pEGFP-N1	CMV IE promoter	BD Biosciences Clontech	
pET22	T7 promoter, <i>lac</i> operator, high copy	Novagen	
pGEX-6p-1	<i>pTac</i> promoter	Amersham	
pTM100	pACYC184- <i>oriT</i>	Michiels and Cornelis (1991)	
Suicide vectors, mutator			
Plasmids	Characteristics	References	
pKNG101	<i>ori</i> R6K, <i>mob</i> RK2, <i>strAB</i> , <i>sacBR</i>	Kaniga <i>et al</i> (1991)	
pML20	pKNG101:: -250/ <i>ΔsycO</i> / + 250	This study	

Oligonucleotides labelled with * were used to delete or mutate domains by inverse polymerase chain reaction using *Pfu* turbo polymerase (Stratagene).

diluted to an OD₆₀₀ of 0.1 in LB with ampicillin 100 µg ml⁻¹ and incubated at 37°C until they reached an OD₆₀₀ of 0.6. Then, the expression of the proteins was induced by adding 0.125 mM IPTG and the cultures were incubated at room temperature (RT) with shaking for 3 h. Cells were harvested by centrifugation, resuspended in PBS containing Triton X-100 0.1% (v/v), protease inhibitors (Complete mini, Roche) and lysed by using a French press. The lysate was spun for 30 min at 6000 g to eliminate unbroken cells and debris. The supernatant was centrifuged for 1 h 30 min at 100 000 g to separate soluble compounds (supernatant) from insoluble ones (pellet).

Kinase assay

Proteins were purified as described in Supplementary data 4. YopO and YopO_{D267A} were eluted together with GST in order to improve their solubility. The purified YopO-(SycO)₂ complex used for the kinase assay was previously run on gel filtration in order to use only proteins associated in a complex. Kinase assays were performed using 5 µg of purified proteins in the kinase reaction buffer: PBS, 20 mM MgCl₂, 1 mM DTT, 0.5 mM ATP and 2 µCi [γ -³²P]ATP, \pm 0.1 µg of purified G-actin (Pierce). The reaction was incubated at 30°C for 30 min and stopped by addition of SDS-PAGE loading buffer. The kinase reactions were loaded on SDS-PAGE gel. The autoradiography was obtained on Phosphor Screen (Molecular Dynamics).

Adenylate cyclase reporter translocation assay

J774 macrophages were grown in RPMI 1640 medium (Gibco BRL), supplemented with 2 mM L-glutamine (Invitrogen), 1 mM sodium pyruvate (Invitrogen), 0.0004% (v/v) β -mercaptoethanol (Sigma) and 10% (v/v) fetal bovine serum (Invitrogen). Adenylate cyclase reporter translocation assays were carried out as described earlier (Sory and Cornelis, 1994). All experiments were performed in triplicate.

References

Aepfelbacher M, Trasak C, Wilharm G, Wiedemann A, Trulzsch K, Krauss K, Gierschik P, Heesemann J (2003) Characterization of YopT effects on Rho GTPases in *Yersinia enterocolitica*-infected cells. *J Biol Chem* **278**: 33217–33223

Agrain C, Sorg I, Paroz C, Cornelis GR (2005) Secretion of YscP from *Yersinia enterocolitica* is essential to control the length of the injectisome needle but not to change the type III secretion substrate specificity. *Mol Microbiol* **57**: 1415–1427

Akeda Y, Galan JE (2005) Chaperone release and unfolding of substrates in type III secretion. *Nature* **437**: 911–915

Barz C, Abahji TN, Trulzsch K, Heesemann J (2000) The *Yersinia* Ser/Thr protein kinase YpkA/YopO directly interacts with the small GTPases RhoA and Rac-1. *FEBS Lett* **482**: 139–143

Benabdillah R, Mota LJ, Lutzelshwab S, Demoinet E, Cornelis GR (2004) Identification of a nuclear targeting signal in YopM from *Yersinia* spp. *Microb Pathog* **36**: 247–261

Birtalan S, Ghosh P (2001) Structure of the *Yersinia* type III secretory system chaperone SycE. *Nat Struct Biol* **8**: 974–978

Birtalan SC, Phillips RM, Ghosh P (2002) Three-dimensional secretion signals in chaperone-effector complexes of bacterial pathogens. *Mol Cell* **9**: 971–980

Black DS, Bliska JB (2000) The RhoGAP activity of the *Yersinia pseudotuberculosis* cytotoxin YopE is required for antiphagocytic function and virulence. *Mol Microbiol* **37**: 515–527

Black DS, Marie-Cardine A, Schraven B, Bliska JB (2000) The *Yersinia* tyrosine phosphatase YopH targets a novel adhesion-regulated signalling complex in macrophages. *Cell Microbiol* **2**: 401–414

Boyd AP, Lambermont I, Cornelis GR (2000) Competition between the Yops of *Yersinia enterocolitica* for delivery into eukaryotic cells: role of the SycE chaperone binding domain of YopE. *J Bacteriol* **182**: 4811–4821

Bronstein PA, Miao EA, Miller SI (2000) InvB is a type III secretion chaperone specific for SspA. *J Bacteriol* **182**: 6638–6644

Buttner CR, Cornelis GR, Heinz DW, Niemann HH (2005) Crystal structure of *Yersinia enterocolitica* type III secretion chaperone SycT. *Protein Sci* **14**: 1993–2002

Cain RJ, Hayward RD, Koronakis V (2004) The target cell plasma membrane is a critical interface for *Salmonella* cell entry effector-host interplay. *Mol Microbiol* **54**: 887–904

Cornelis G, Sory MP, Laroche Y, Derclaye I (1986) Genetic analysis of the plasmid region controlling virulence in *Yersinia*

Transfection and fluorescence microscopy

HEK293T cells were grown in Dulbecco's modified Eagle's medium (Gibco BRL), supplemented with 10% (v/v) fetal bovine serum (Invitrogen) and 1 mM sodium pyruvate (Invitrogen). Coverslips (Huber & Co) were coated with poly-L-lysine (BD Diagnostic System), and 10⁴ cells well⁻¹ were seeded in 500 µl of media. The next day, cells were transfected following the calcium phosphate procedure. Cells were grown for 24 h, stained with 10 µg ml⁻¹ wheat germ agglutinin Texas Red[®]-X conjugate (Molecular Probes) for 7 min at RT and fixed for 20 min in 3% paraformaldehyde in PBS. For Giantin and LAMP1 staining, cells were permeabilized with 0.1% saponin in PBS containing 3% BSA, incubated during 40 min with α -Giantin (G1/133) or α -LAMP1 (G1/139) (Axxora), washed and incubated for 30 min with a Texas Red[®]-coupled secondary antibody (Molecular Probes). Slides were examined with a Leica TCS SP confocal microscope. Pictures were processed with the Leica confocal software version 2.5.

Supplementary data

Supplementary data are available at *The EMBO Journal* Online.

Acknowledgements

We thank C Dieterich and M-P Sory for pCD10, I Lambermont for pILB3, C Geuijen for pYOB2, M Folcher for assistance in protein purifications, T Rhomberg for assistance in microscopy, H Reichert for the use of a confocal microscope and H-P Hauri for discussions and the α -Giantin and α -LAMP1 antibodies. This work was supported by the Swiss National Science Foundation (grant 32-65393.01).

enterocolitica 0:9 by Mini-Mu insertions and lac gene fusions. *Microb Pathog* **1**: 349–359

Cornelis G, Vanootegem JC, Sluifers C (1987) Transcription of the yop regulon from *Y. enterocolitica* requires *trans* acting pYV and chromosomal genes. *Microb Pathog* **2**: 367–379

Cornelis GR (2002) The *Yersinia* Ysc-Yop 'type III' weaponry. *Nat Rev Mol Cell Biol* **3**: 742–752

Cornelis GR, Wolf-Watz H (1997) The *Yersinia* Yop virulon: a bacterial system for subverting eukaryotic cells. *Mol Microbiol* **23**: 861–867

Darwin KH, Robinson LS, Miller VL (2001) SigE is a chaperone for the *Salmonella enterica* serovar Typhimurium invasion protein SigD. *J Bacteriol* **183**: 1452–1454

Dukuzumuremyi JM, Rosqvist R, Hallberg B, Akerstrom B, Wolf-Watz H, Schesser K (2000) The *Yersinia* protein kinase A is a host factor inducible RhoA/Rac-binding virulence factor. *J Biol Chem* **275**: 35281–35290

Ehrbar K, Friebel A, Miller SI, Hardt WD (2003) Role of the *Salmonella* pathogenicity island 1 (SPI-1) protein InvB in type III secretion of SopE and SopE2, two *Salmonella* effector proteins encoded outside of SPI-1. *J Bacteriol* **185**: 6950–6967

Elliott SJ, Hutcheson SW, Dubois MS, Mellies JL, Wainwright LA, Batchelor M, Frankel G, Knutton S, Kaper JB (1999) Identification of CesT, a chaperone for the type III secretion of Tir in enteropathogenic *Escherichia coli*. *Mol Microbiol* **33**: 1176–1189

Evdokimov AG, Tropea JE, Routzahn KM, Waugh DS (2002) Three-dimensional structure of the type III secretion chaperone SycE from *Yersinia pestis*. *Acta Crystallogr D* **58**: 398–406

Feldman MF, Cornelis GR (2003) The multitalented type III chaperones: all you can do with 15 kDa. *FEMS Microbiol Lett* **219**: 151–158

Fu Y, Galan JE (1998) Identification of a specific chaperone for SptP, a substrate of the centisome 63 type III secretion system of *Salmonella typhimurium*. *J Bacteriol* **180**: 3393–3399

Fu Y, Galan JE (1999) A *Salmonella* protein antagonizes Rac-1 and Cdc42 to mediate host-cell recovery after bacterial invasion. *Nature* **401**: 293–297

Galyov EE, Hakansson S, Forsberg A, Wolf-Watz H (1993) A secreted protein kinase of *Yersinia pseudotuberculosis* is an indispensable virulence determinant. *Nature* **361**: 730–732

- Galyov EE, Hakansson S, Wolf-Watz H (1994) Characterization of the operon encoding the YpkA Ser/Thr protein kinase and the YopJ protein of *Yersinia pseudotuberculosis*. *J Bacteriol* **176**: 4543–4548
- Ghosh P (2004) Process of protein transport by the type III secretion system. *Microbiol Mol Biol Rev* **68**: 771–795
- Hakansson S, Galyov EE, Rosqvist R, Wolf-Watz H (1996) The *Yersinia* YpkA Ser/Thr kinase is translocated and subsequently targeted to the inner surface of the HeLa cell plasma membrane. *Mol Microbiol* **20**: 593–603
- Iriarte M, Cornelis GR (1998) YopT, a new *Yersinia* Yop effector protein, affects the cytoskeleton of host cells. *Mol Microbiol* **29**: 915–929
- Iriarte M, Cornelis GR (1999) The 70-kilobase virulence plasmid of *Yersinia*. In *Pathogenicity Islands and Other Mobile Virulence Elements*, Kaper JB, Hacker J (eds) pp 91–126. Washington, DC: American Society for Microbiology
- Juris SJ, Rudolph AE, Huddler D, Orth K, Dixon JE (2000) A distinctive role for the *Yersinia* protein kinase: actin binding, kinase activation, and cytoskeleton disruption. *Proc Natl Acad Sci USA* **97**: 9431–9436
- Kaniga K, Delor I, Cornelis GR (1991) A wide-host-range suicide vector for improving reverse genetics in gram-negative bacteria: inactivation of the blaA gene of *Yersinia enterocolitica*. *Gene* **109**: 137–141
- Kovach ME, Elzer PH, Hill DS, Robertson GT, Farris MA, Roop II RM, Peterson KM (1995) Four new derivatives of the broad-host-range cloning vector pBBR1MCS, carrying different antibiotic-resistance cassettes. *Gene* **166**: 175–176
- Kenny B, DeVinney R, Stein M, Reinscheid DJ, Frey EA, Finlay BB (1997) Enteropathogenic *E. coli* (EPEC) transfers its receptor for intimate adherence into mammalian cells. *Cell* **91**: 511–520
- Krall R, Zhang Y, Barbieri JT (2004) Intracellular membrane localization of pseudomonas ExoS and *Yersinia* YopE in mammalian cells. *J Biol Chem* **279**: 2747–2753
- Kubori T, Matsushima Y, Nakamura D, Uralil J, Lara-Tejero M, Sukhan A, Galan JE, Aizawa SI (1998) Supramolecular structure of the *Salmonella typhimurium* type III protein secretion system. *Science* **280**: 602–605
- Lee SH, Galan JE (2004) *Salmonella* type III secretion-associated chaperones confer secretion-pathway specificity. *Mol Microbiol* **51**: 483–495
- Locher M, Lehnert B, Krauss K, Heesemann J, Groll M, Willharm G (2005) Crystal structure of the *Yersinia enterocolitica* Type III secretion chaperone SycT. *J Biol Chem* **280**: 31149–31155
- Luo Y, Bertero MG, Frey EA, Pfluetzner RA, Wenk MR, Creagh L, Marcus SL, Lim D, Sicheri F, Kay C, Haynes C, Finlay BB, Strynadka NC (2001) Structural and biochemical characterization of the type III secretion chaperones CesT and SigE. *Nat Struct Biol* **8**: 1031–1036
- Marcus SL, Knodler LA, Finlay BB (2002) *Salmonella enterica* serovar Typhimurium effector SigD/SopB is membrane-associated and ubiquitinated inside host cells. *Cell Microbiol* **4**: 435–446
- Menard R, Sansonetti P, Parsot C, Vasselot T (1994) Extracellular association and cytoplasmic partitioning of the IpaB and IpaC invasins of *S. flexneri*. *Cell* **79**: 515–525
- Michiels T, Cornelis GR (1991) Secretion of hybrid proteins by the *Yersinia* Yop export system. *J Bacteriol* **173**: 1677–1685
- Mills SD, Boland A, Sory MP, van der Smissen P, Kerbouch C, Finlay BB, Cornelis GR (1997) *Yersinia enterocolitica* induces apoptosis in macrophages by a process requiring functional type III secretion and translocation mechanisms and involving YopP, presumably acting as an effector protein. *Proc Natl Acad Sci USA* **94**: 12638–12643
- Montagna LG, Ivanov MI, Bliska JB (2001) Identification of residues in the N-terminal domain of the *Yersinia* tyrosine phosphatase that are critical for substrate recognition. *J Biol Chem* **276**: 5005–5011
- Mueller CA, Broz P, Muller SA, Ringler P, Erne-Brand F, Sorg I, Kuhn M, Engel A, Cornelis GR (2005) The V-antigen of *Yersinia* forms a distinct structure at the tip of injectisome needles. *Science* **310**: 674–676
- Neyt C, Cornelis GR (1999) Insertion of a Yop translocation pore into the macrophage plasma membrane by *Yersinia enterocolitica*: requirement for translocators YopB and YopD, but not LcrG. *Mol Microbiol* **33**: 971–981
- Norris FA, Wilson MP, Wallis TS, Galyov EE, Majerus PW (1998) SopB, a protein required for virulence of *Salmonella dublin*, is an inositol phosphate phosphatase. *Proc Natl Acad Sci USA* **95**: 14057–14059
- Page AL, Sansonetti P, Parsot C (2002) Spa15 of *Shigella flexneri*, a third type of chaperone in the type III secretion pathway. *Mol Microbiol* **43**: 1533–1542
- Parsot C, Hamiaux C, Page AL (2003) The various and varying roles of specific chaperones in type III secretion systems. *Curr Opin Microbiol* **6**: 7–14
- Persson C, Nordfelth R, Andersson K, Forsberg A, Wolf-Watz H, Fallman M (1999) Localization of the *Yersinia* PTPase to focal complexes is an important virulence mechanism. *Mol Microbiol* **33**: 828–838
- Pettersson J, Nordfelth R, Dubinina E, Bergman T, Gustafsson M, Magnusson KE, Wolf-Watz H (1996) Modulation of virulence factor expression by pathogen target cell contact. *Science* **273**: 1231–1233
- Phan J, Tropea JE, Waugh DS (2004) Structure of the *Yersinia pestis* type III secretion chaperone SycH in complex with a stable fragment of YscM2. *Acta Crystallogr D* **60**: 1591–1599
- Sarker MR, Neyt C, Stainier I, Cornelis GR (1998) The *Yersinia* Yop virulon: LcrV is required for extrusion of the translocators YopB and YopD. *J Bacteriol* **180**: 1207–1214
- Schlumberger MC, Muller AJ, Ehrbar K, Winnen B, Duss I, Stecher B, Hardt WD (2005) Real-time imaging of type III secretion: *Salmonella* SipA injection into host cells. *Proc Natl Acad Sci USA* **102**: 12548–12553
- Shao F, Merritt PM, Bao Z, Innes RW, Dixon JE (2002) A yersinia effector and a pseudomonas avirulence protein define a family of cysteine proteases functioning in bacterial pathogenesis. *Cell* **109**: 575–588
- Sory MP, Boland A, Lambermont I, Cornelis GR (1995) Identification of the YopE and YopH domains required for secretion and internalization into the cytosol of macrophages, using the cyaA gene fusion approach. *Proc Natl Acad Sci USA* **92**: 11998–12002
- Sory MP, Cornelis GR (1994) Translocation of a hybrid YopE-adenylate cyclase from *Yersinia enterocolitica* into HeLa cells. *Mol Microbiol* **14**: 583–594
- Stebbins CE, Galan JE (2001) Maintenance of an unfolded polypeptide by a cognate chaperone in bacterial type III secretion. *Nature* **414**: 77–81
- Trame CB, McKay DB (2003) Structure of the *Yersinia enterocolitica* molecular-chaperone protein SycE. *Acta Crystallogr D* **59**: 389–392
- Tran Van Nhieu G, Bourdet-Sicard R, Dumenil G, Blocker A, Sansonetti PJ (2000) Bacterial signals and cell responses during *Shigella* entry into epithelial cells. *Cell Microbiol* **2**: 187–193
- Trulzsch K, Roggenkamp A, Aepfelbacher M, Willharm G, Ruckdeschel K, Heesemann J (2003) Analysis of chaperone-dependent Yop secretion/translocation and effector function using a mini-virulence plasmid of *Yersinia enterocolitica*. *Int J Med Microbiol* **293**: 167–177
- van Eerde A, Hamiaux C, Perez J, Parsot C, Dijkstra BW (2004) Structure of Spa15, a type III secretion chaperone from *Shigella flexneri* with broad specificity. *EMBO Rep* **5**: 477–483
- Von Pawel-Rammingen U, Telepnev MV, Schmidt G, Aktories K, Wolf-Watz H, Rosqvist R (2000) GAP activity of the *Yersinia* YopE cytotoxin specifically targets the Rho pathway: a mechanism for disruption of actin microfilament structure. *Mol Microbiol* **36**: 737–748
- Wattiau P, Bernier B, Deslee P, Michiels T, Cornelis GR (1994) Individual chaperones required for Yop secretion by *Yersinia*. *Proc Natl Acad Sci USA* **91**: 10493–10497
- Wattiau P, Cornelis GR (1993) SycE, a chaperone-like protein of *Yersinia enterocolitica* involved in the secretion of YopE. *Mol Microbiol* **8**: 123–131
- Woestyn S, Allaoui A, Wattiau P, Cornelis GR (1994) YscN, the putative energizer of the *Yersinia* Yop secretion machinery. *J Bacteriol* **176**: 1561–1569
- Woestyn S, Sory MP, Boland A, Lequenne O, Cornelis GR (1996) The cytosolic SycE and SycH chaperones of *Yersinia* protect the region of YopE and YopH involved in translocation across eukaryotic cell membranes. *Mol Microbiol* **20**: 1261–1271
- Zhou H, Monack DM, Kayagaki N, Wertz I, Yin J, Wolf B, Dixit VM (2005) *Yersinia* virulence factor YopJ acts as a deubiquitinase to inhibit NF- κ B activation. *J Exp Med* **202**: 1327–1332
- Zumbihl R, Aepfelbacher M, Andor A, Jacobi CA, Ruckdeschel K, Rouot B, Heesemann J (1999) The cytotoxin YopT of *Yersinia enterocolitica* induces modification and cellular redistribution of the small GTP-binding protein RhoA. *J Biol Chem* **274**: 29289–29293

V. Supplementary Material

In silico study of SycO: (Supplementary material 1)

***orf155* encodes a protein which presents the characteristics of class I chaperones:**

The operon encoding YopO and YopP (Fig S1A) contains *orf155*. A similar *orf* is found in the three pathogenic *Yersinia* species (Fig S1B). Although the size varies from 142 to 155 residues, the proteins are 98 % identical within their 133 first residues. Similarities between Orf155 and other effector chaperones were investigated using PSI-BLAST (Altschul *et al.*, 1997) and fold recognition algorithms 3D-PSSM (Kelley *et al.*, 2000) and FUGUE (Shi *et al.*, 2001). These studies revealed low but significant similarities of the conserved protein sequence with various T3S chaperones, including those of CesT, the chaperone of the enteropathogenic *E. coli* effector Tir (Thomas *et al.*, 2005) and of SicP, the chaperone of *Salmonella* effector SptP (Fu and Galan, 1998). Hydrophobic cluster analysis (Callebaut *et al.*, 1997) allowed to point out two dimensional similarities refining the proposed alignment (Fig S1C and S1D). The model of the three-dimensional structure of the *orf155* gene product, build with the program MODELLER (Sali *et al.*, 1995) on the basis of this alignment using the SicP structure as template, showed an organization of the chaperone core structure very similar to those of several T3S chaperones (Fig S1E, 0.57 Å root mean square deviation (C α atoms)). The model was constructed in a dimeric form, based on the dimer observed in the crystal structure of the SicP/SptP complex. As in SicP, several hydrophobic residues form hydrophobic patches at the surface of the dimer, which could be involved in the interaction with the effector (data not shown). These observations suggested that *orf155* encodes the chaperone of an effector.

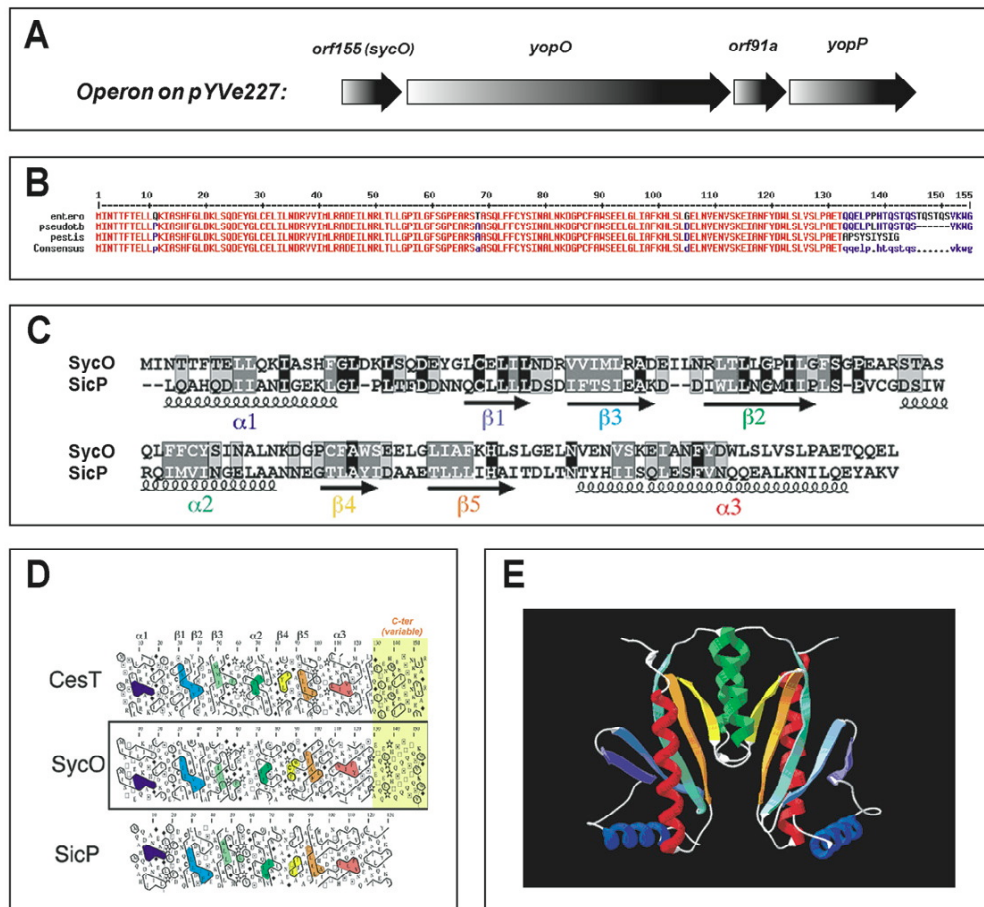

Fig S1: In silico study of *orf155*.

A. The operon encoding YopO and YopP starts with *orf155* in all three *Yersinia* pathogenic *Yersinia* species. **B.** The *orf155* is highly conserved in the three species (entero = *Y. enterocolitica*; pseudob = *Y. pseudotuberculosis*; pestis = *Y. pestis*), which is not the case for *orf91a*. **C.** Alignment of the SycO sequence with that of SicP, the three-dimensional structure of which is known (Stebbins and Galan, 2001). This alignment was deduced from PSI-BLAST and fold recognition methods and was refined using "Hydrophobic Cluster Analysis" (HCA, see below). **D.** Comparison of the 2D HCA plot of the SycO sequence with those of CesT and SicP, highlighting the conservation of a common core of hydrophobic residues. The sequences are shown on duplicated alpha-helical nets, in which hydrophobic residues (VILFMYW) are contoured. These form clusters, which mainly correspond to regular secondary structures. Correspondences to the observed secondary structures (CesT and SicP) are indicated above the plots. Cluster similarities, indicating the conservation of a common hydrophobic core, are shown in color. Note that the C-terminal sequences, following the conserved common cores, are variable from one sequence to another one (or is even absent in SicP). **E.** Model of the three-dimensional structure of the SycO dimer, based on the dimer structure of SicP (Stebbins and Galan, 2001). Colors of regular secondary structures are as in panel D.

Stoichiometry analysis of the YopO-SycO complex by crosslinking: (Supplementary material 2)

SycO is a dimer and binds as a dimer (Fig. S2):

Since the CBD is localized in the N-terminal domain of the protein, a truncated version of YopO was used to determine the stoichiometry of the complex. A GST-YopO₂₀₀ fusion protein was co-expressed with SycO in *E. coli* BL21 and the complex was adsorbed on glutathione sepharose, eluted by proteolytic cleavage of the GST moiety, cross-linked with glutaraldehyde and analyzed by SDS-PAGE and immuno-blotting. Cross-linking led to a shift in the apparent molecular mass of SycO from 17 kDa to 55 kDa suggesting that YopO₂₀₀ was associated with two molecules of SycO (Fig S2A). YopO₂₀₀ (21 kDa) was not detected any more after cross-linking, suggesting that all the proteins reacted in the cross-linking reaction. However, the cross-linked product was not clearly detectable with the α -YopO antibodies, which could result from the fact that most of the YopO epitopes that remain in this truncated protein are hidden by the chaperones. In agreement with this hypothesis, when YopO_{his} full-length was cross-linked with SycO, a high molecular mass complex was detected by the α -YopO antibodies (Fig S2B). The SycO-YopO₂₀₀ complex was also analyzed by size exclusion chromatography and its apparent molecular weight was evaluated around 60-70 kDa (data not shown), suggesting that the stoichiometry of the complex is indeed two SycO chaperones for one YopO. Finally, we analyzed the state of SycO in the absence of YopO. Purified native SycO was crosslinked with glutaraldehyde and its apparent molecular mass appeared to be around 35 kDa, indicating that unbound SycO exists as a dimer (Fig S2C).

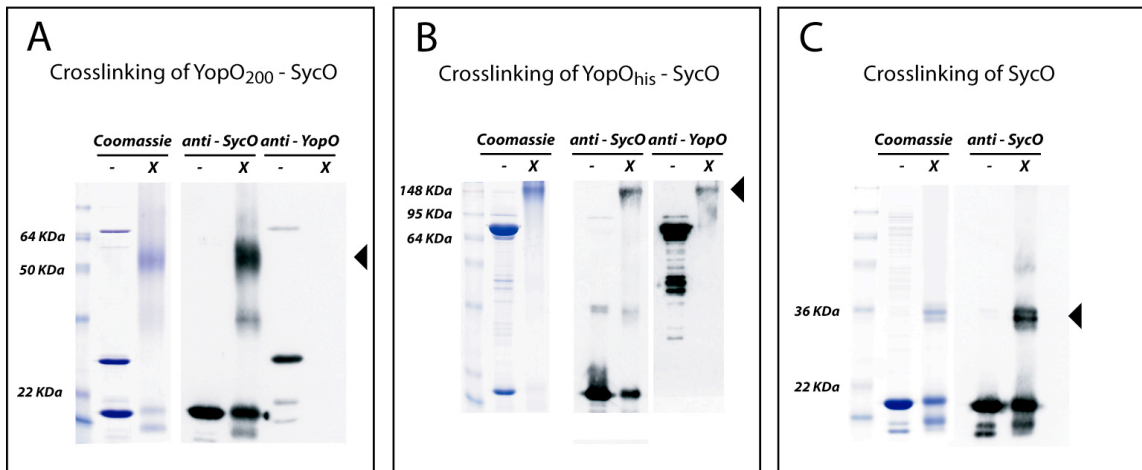

Figure S2 : Stoichiometry of the YopO-SycO complex by crosslinking.

A. The complex between YopO₂₀₀ and SycO, obtained after cleavage of GST-YopO₂₀₀-(SycO)₂ was treated with glutaraldehyde 0.25 % (v/v) for 5 min at room temperature. The reaction was stopped on ice by the addition of 100 mM Tris-HCl pH 8.0. The products were analyzed by Coomassie-stained SDS-PAGE and western blotting. The arrow points to the ca 55-kDa cross-linked product. X = lanes with the cross-linker; - = control lanes.

B. Same experiment as in A with the YopO_{his}-(SycO)₂ complex preparation loaded in lane L of panel A.

C. Purified SycO protein cross-linked as in A and B.

**In silico study of YopO and YopE chaperone binding domain:
(Supplementary online material 3)**

The HCA plots of the YopO and YopE CBDs are shown (see legend of Fig S1 for explanation), highlighting similarities within hydrophobic clusters (shaded grey). Sequence identities are reported in white on a black background. These similarities suggest a common secondary structure organization between the two protein domains. Secondary structures, as observed in the YopE/SycE complex (PDB 1L2W, (Birtalan *et al.*, 2002)), are reported below the YopE sequence. A ribbon representation of the YopE/SycE complex 3D structure is shown at the bottom, with the YopE CBD shown in black.

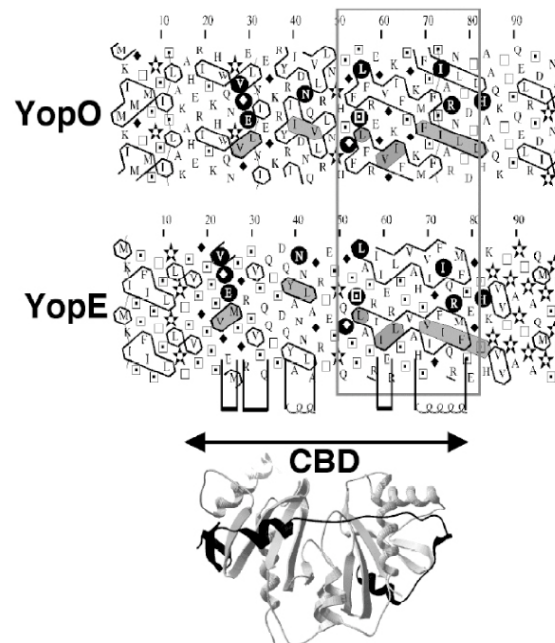

Protein purification and analysis: (Supplementary online material 4)

In order to perform different *in vitro* studies, we prepared several protein purifications. YopO_{his} co-expressed with SycO was purified to study the stoichiometry of the complex by crosslinking and size exclusion chromatography. GST fusions with different versions of YopO were used to investigate the stoichiometry, and to test the kinase activity of YopO with or without its chaperone SycO. Native SycO was also purified for antibody production, stoichiometry analysis and for eventual future crystallization. Purified YopO and SycO were also used to study their solubility *in vitro*.

Purification of the YopO_{his}-(SycO)₂ complex (Fig. 16):

YopO_{his} and SycO were co-produced in *E. coli* BL21 from the pET22-derived plasmid pML9. Bacteria were grown overnight at 37 °C, diluted to an OD₆₀₀ of 0.1 in LB with ampicillin 100 µg ml⁻¹ and incubated at 37 °C until they reached an OD₆₀₀ of 0.6. Then, the expression of the proteins was induced by adding 0.125 mM IPTG and the cultures were incubated at room temperature (RT) with shaking for 3 hours. Cells were harvested by centrifugation, resuspended in PBS containing Triton X100 0.1 % (v/v), proteases inhibitors (Complete mini, Roche) and lysed using a French press. The lysate was spun for 30 min at 6000 g to eliminate unbroken cells and debris. YopO_{his} was purified on Ni²⁺- Sepharose (Amersham). After several washing steps with 100 mM imidazole, YopO_{his} and SycO were eluted with 300 mM imidazole.

Purification of the GST-YopO fusions (Fig. 17):

GST-YopO (pML10), GST-YopO_{Δ20-77} (pML11) and GST-YopO_{D267A} (pML12) were produced in *E. coli* Top10. GST-YopO (pML10) and SycO (pML15) were co-expressed in *E. coli* BL21. Bacteria were cultivated in 100 ml LB medium at 37 °C up to an OD₆₀₀ of 0.6. Expression of the fusion proteins was induced by addition of 0.125 mM IPTG. Cultures were then grown for 3 hours at room temperature (RT). Bacterial pellets were resuspended in Phosphate Buffered Saline (PBS) containing Triton X100 0.1 % (v/v), proteases inhibitors (Complete mini, Roche) and lysed by sonication. Unbroken cells and debris were removed by centrifugation (30 min, 6000g). The supernatant was incubated with Glutathione Sepharose 4B (Amersham) for 2 hours at 4 °C. The matrix was pelleted by centrifugation 500 g for 2 min. The supernatant was discarded and the matrix was washed 4 times with ice-cold PBS.

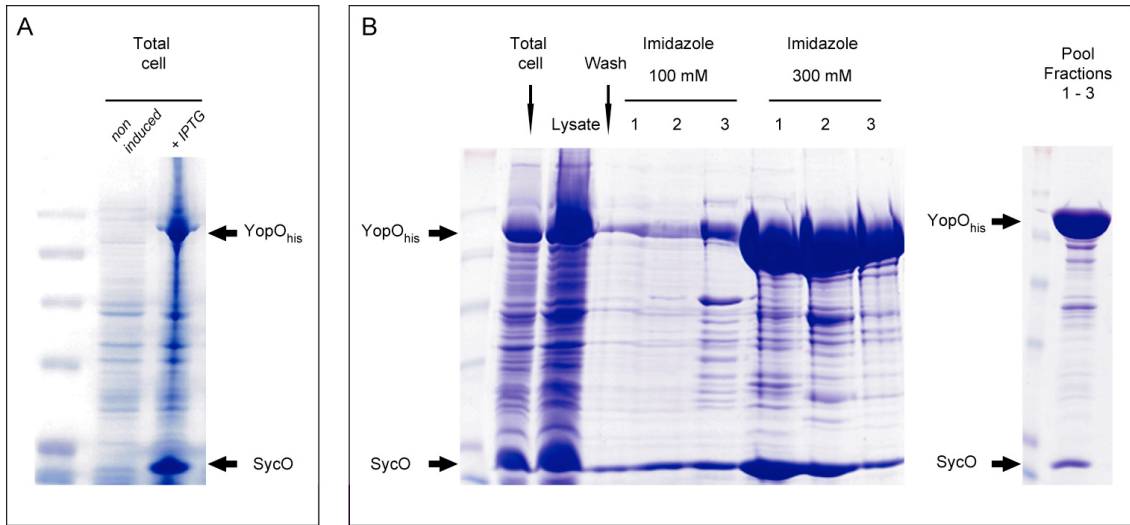

Figure 16 : YopO_{his} – SycO complex purification.

YopO_{his} and *sycO* were co-expressed in *E. coli* BL21 from pML9. Samples of bacteria were analysed by Coomassie stained SDS PAGE (Fig. 16A), before induction (non induced) and after three hours of induction (+IPTG). After lysis cells debris were eliminated by centrifugation and the supernatant was loaded on Nickel Sepharose (His-Trap™). After washing with loading buffer (Wash), two step gradients of imidazole were applied. *YopO_{his}* and *SycO* co-eluted at a concentration of 300 mM imidazole (Fig. 16B). The three fractions were pooled for further experiments.

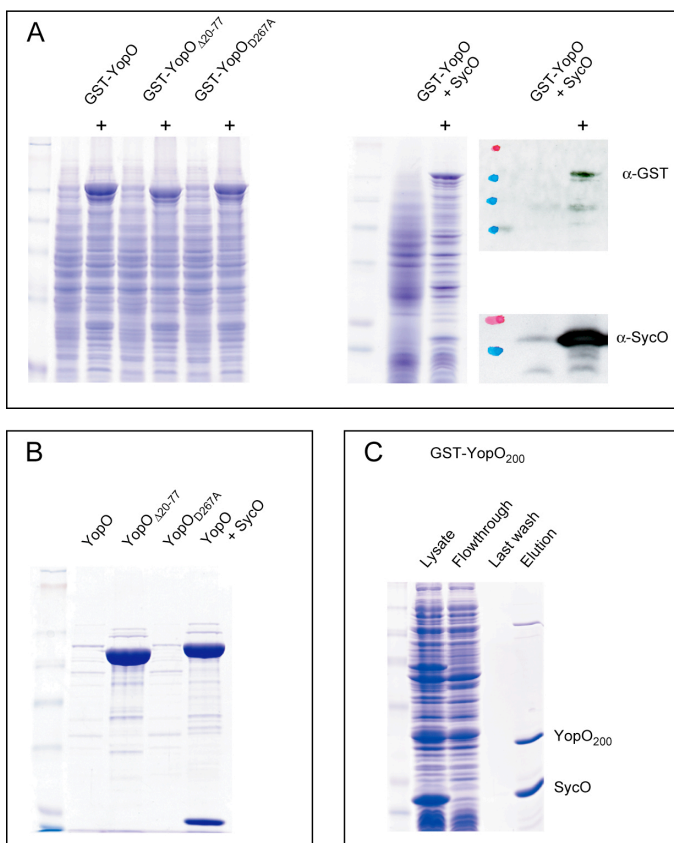

Figure 17: GST fusions purification.

GST-YopO, GST-YopO_{Δ20-77}, GST-YopO_{D267A} were produced in *E. coli* Top10 from pML10, 11, 12 respectively. GST-YopO and SycO were co-produced in *E. coli* BL21 from pML10 and 15. Samples of bacteria were analysed by Coomassie stained SDS PAGE (Fig. 17A), before induction (-) and after three hours of IPTG induction (+). The expression of *sycO* was checked by Western blot analysis. After standard purification procedure (cf. Supplementary material) and Precision protease elution, purified fractions were loaded on SDS PAGE and stained with Coomassie (Fig. 17B). GST-YopO₂₀₀ was co-produced with SycO and purified following the standard procedure (Fig. 17C) (cf. Supplementary material).

YopO, YopO_{Δ20-77}, YopO_{D267A}, and YopO bound to SycO were eluted using Prescission Protease from Amersham (3 h at 4 °C). Matrix was sedimented at 500 g for 2 min, and discarded. The supernatant containing the proteins was checked by SDS PAGE. A major difference in the recovered protein was observed comparing YopO and YopO_{D267A} to the others. According to the previous observations made about the solubility of YopO due to the chaperone binding domain. Repeating the same experience, we hypothesized that YopO could aggregate on the matrix. We then decided to elute YopO and YopO_{D267A}, with the GST moiety to improve a bit the solubility. After the washing steps, GST-YopO and GST-YopO_{D267A} were eluted by addition of PBS with 10 mM reduced glutathione to the matrix and incubated for 30 min at 4 °C.

YopO₂₀₀ was produced from pML13 with SycO (pML15) in *E. coli* BL21. Expression and purification was made following the procedure described above for YopO_{Δ20-77} and YopO co-expressed with SycO.

Purification of SycO (Fig. 18) :

Expression of SycO. *E. coli* Top10 containing pML14 (pBAD::*sycO*) were grown in 25 l LB medium at 37 °C. Expression of *sycO* was induced at an OD₆₀₀ of 0.6 by the addition of 0.2 % (w/v) arabinose and the culture was grown for three additional hours. The expression was checked on Comassie (Fig. 18A).

On the 90 grams of bacteria harvested, 30 grams were lysed using a French press in presence of proteases inhibitors (Complete mini, Roche). Unbroken cells and debris were pelleted by centrifugation during 30 min at 6000 g.

Ammonium sulfate precipitation. The lysate was sequentially precipitated with ammonium sulfate. Two cut offs were performed: 30 % and 45 % (w/v) ammonium sulfate. SycO, precipitated with 30% ammonium sulfate, was dialyzed and further purified by successive chromatography. All purifications and dialyses were done in HEPES buffer : HEPES 50 mM, NaCl 50 mM, DTT 1 mM buffer containing proteases inhibitors (Complete mini, Roche).

DEAE-Sepharose (Amersham): (Fig. 18B). The dialyzed sample from ammonium sulfate precipitation was loaded on DEAE Sepharose. The separation was made applying a gradient of NaCl from 50 mM to 500 mM. Fractions 32 to 38 were pooled and dialyzed overnight in HEPES buffer.

Q-Sepharose (Amersham): (Fig. 18C). The dialyzed 32-38 pool was loaded on Q-sepharose. The separation was made applying a gradient of NaCl from 50 mM to 500 mM. Fractions 52 to 63 were collected in a first pool (Pool 1) and dialyzed. Fractions 64 to 84 (Pool 2) were also

collected and kept frozen at -80°C in 10 % Glycerol after dialysis in Hepes buffer. The Pool 1 was concentrated from 45 ml to 20 ml with a stirred cell Amicon 8050.

Mono Q (Amersham): (Fig. 18D). One ml of the Q-Sepharose pool 1 was loaded on Mono-Q. The separation was made applying a gradient of NaCl from 50 mM to 500 mM. Except the fraction 19, some high molecular weight contaminants were present in almost all the other fractions of interest (20 to 27). Another final step was then tested, by size exclusion chromatography.

Sephacryl S-300 (Amersham): (Fig. 18E). One ml of the Q-Sepharose pool 1 was loaded on Sephacryl S-300 and eluted with Hepes buffer. The final concentration of purified SycO was 1 mg/ml in 15 ml without concentration.

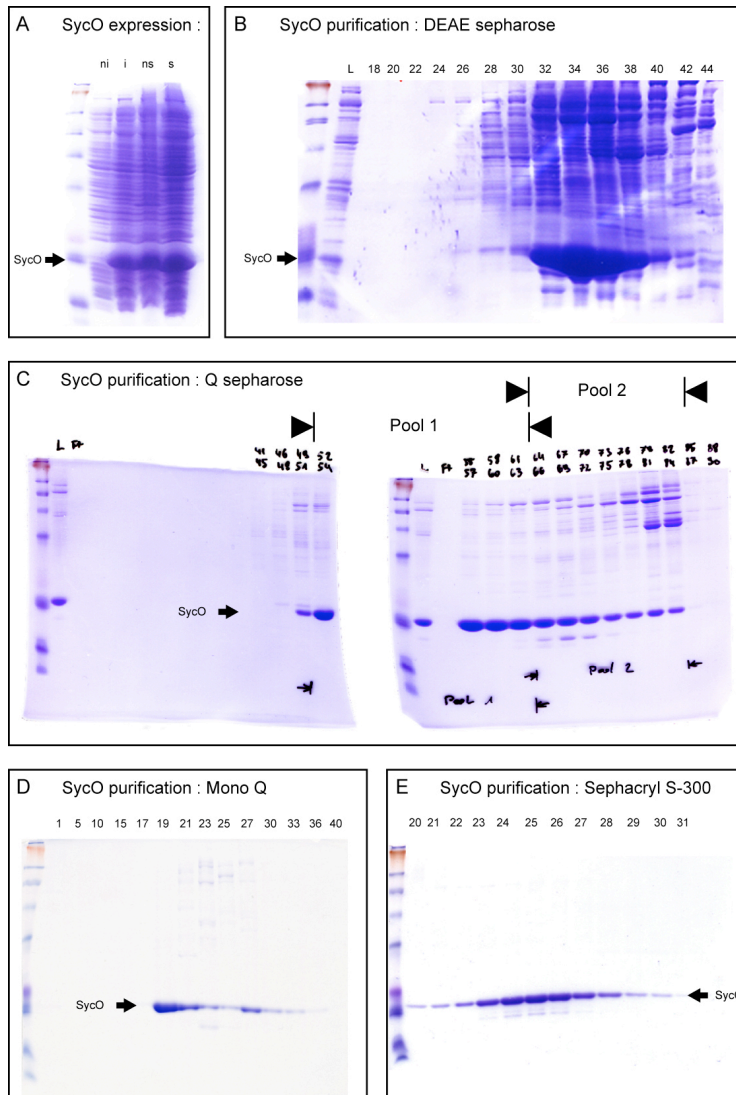

Figure 18 : SycO purification.

SycO was expressed from pML14 in *E. coli* Top10. Samples of bacteria were analysed by Coomassie stained SDS PAGE (Fig. 18A), before induction (ni), three hours after arabinose induction (i). After induction a sample of bacteria was lysed. Soluble (s) and insoluble (ns) fractions were separated and analysed. After ammonium sulfate precipitation and dialysis, proteins were loaded on DEAE sepharose and eluted applying a NaCl gradient (Fig. 18B). The protein separation and the content of the fractions was analysed by Coomassie stained SDS PAGE. Most of the SycO protein was present in fractions 32 to 38. These fractions were pooled, dialysed and loaded on Q sepharose (Fig. 18C). Eluted fractions were loaded on SDS gels and stained by Coomassie. Two pools were collected, from fraction 51 to 63 (Pool 1) and from fraction 64 to 84 (Pool 2). Further purification steps were made of sample issued from the Pool 1 after dialysis. A sample was separated by MonoQ (Fig. 18D) and another by size exclusion chromatography (Fig. 18E).

Antibody production:

A sample containing 1.5 mg of purified SycO was sent to the CER of Marloi (Belgium) for antibody production.

VI. Unpublished Results

Stoichiometry analysis of the YopO - SycO complex by Analytical size exclusion chromatography (Fig. 19) :

The crosslinking data about the complexes stoichiometry published in Letzelter *et al.* were supported by size exclusion chromatography analyses. Purified proteins were loaded on Superdex™ 200 PC 3.2/30 gel filtration column (Amersham). All runs were performed in PBS containing 1 mM DTT. The peaks corresponding to the retention volumes have been integrated and compared to the calibration run of the column (Fig. 19).

YopO alone eluted in the void volume as aggregates. All other proteins : YopO_{his}-SycO complex, YopO_{Δ20-77}, YopO₂₀₀-SycO complex and SycO were eluted according to their apparent molecular mass. YopO has a molecular mass of 81.3 kDa, YopO_{Δ20-77} of 74.8 kDa, YopO₂₀₀ of 22.1 kDa, and SycO of 17.2 kDa. SycO alone in solution eluted with an apparent molecular mass of 31 kDa. The apparent molecular mass of complexes YopO-SycO (120 kDa) or YopO₂₀₀-SycO (62 kDa) fitted with a 1:2 stoichiometry, confirming crosslinking observations. The stoichiometry of the YopO-SycO complex is typical from the Class I chaperone effector complexes.

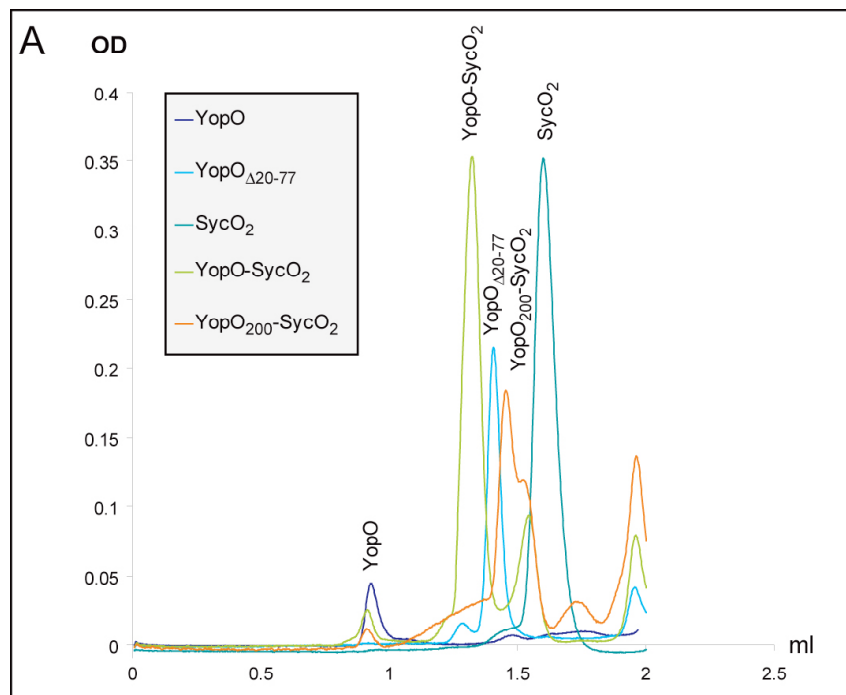

Figure 19A : Stoichiometry analysis by Size exclusion chromatography.

The apparent molecular mass of purified proteins and complexes was determined by gel filtration to analyse their stoichiometry. Purified YopO, YopO_{Δ20-77}, SycO, YopO_{his} or YopO₂₀₀ in complex with SycO were loaded on Superdex 200 PC 3.2/30. Elution profiles are presented in Figure 19A, analysis of the data are presented in Figure 19B (next page).

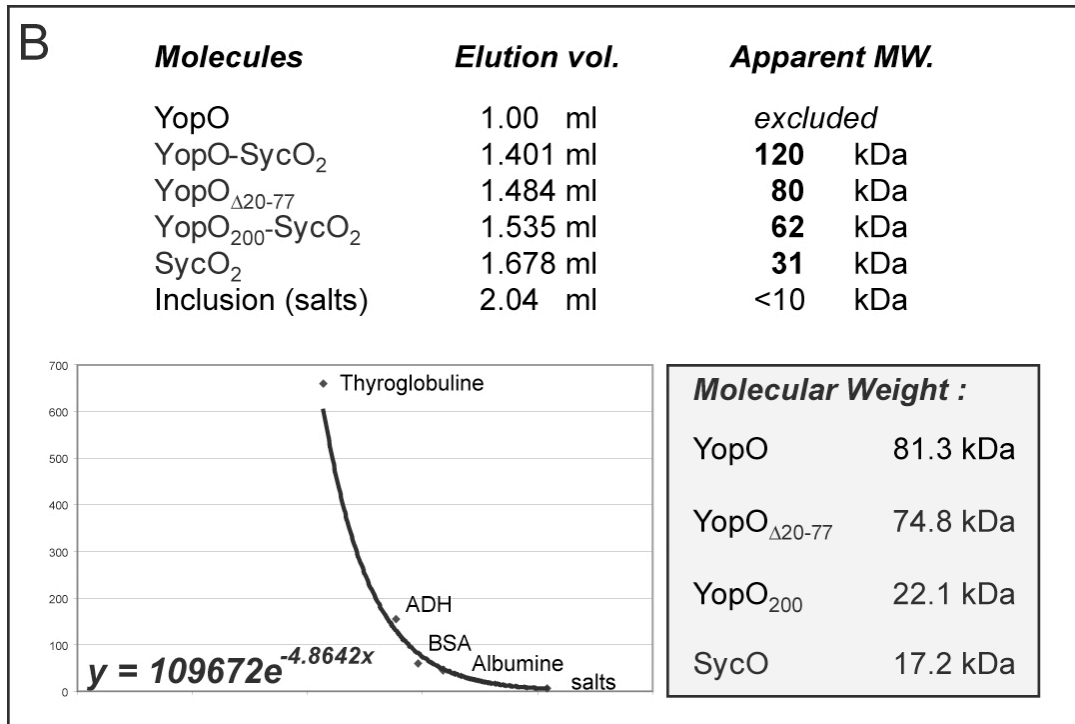

Figure 19B : Stoichiometry analysis by Size exclusion chromatography.

Elution volumes were compared the elution volume of the molecular standards and the apparent molecular mass of the proteins and the complexes was determined.

In vitro binding and solubilization of YopO by SycO (Fig. 20) :

YopO is aggregating through its chaperone binding domain and this event is prevented by the presence of the chaperone. We checked if the binding of the chaperone could occur *in vitro* using purified proteins. Purified YopO (~ 5 μg) was mixed and incubated with purified SycO added in large excess (~ 20 μg). After overnight incubation at 4 °C (as described in (Birtalan *et al.*, 2002)) the protein mixture was loaded on Superdex™ 200 PC 3.2/30 and analyzed.

YopO alone eluted as previously in the void volume around fraction 3-4 (Fig. 20A). When YopO was incubated with SycO part of it still eluted in the void volume. Nevertheless, we could observe some YopO eluting until fractions 9-10 (Fig. 20B). These fractions corresponded to the volume at which the YopO-SycO₂ complex usually eluted. Thus, part of the aggregated YopO could be solubilized *in vitro* by the binding of SycO. However, the efficiency is limited and was

weakly visible on the elution profile. In order to bind in an efficient way, chaperones may rather associate in a co-translational way with their partner -before they undergo aggregation- than with post-synthesized substrate.

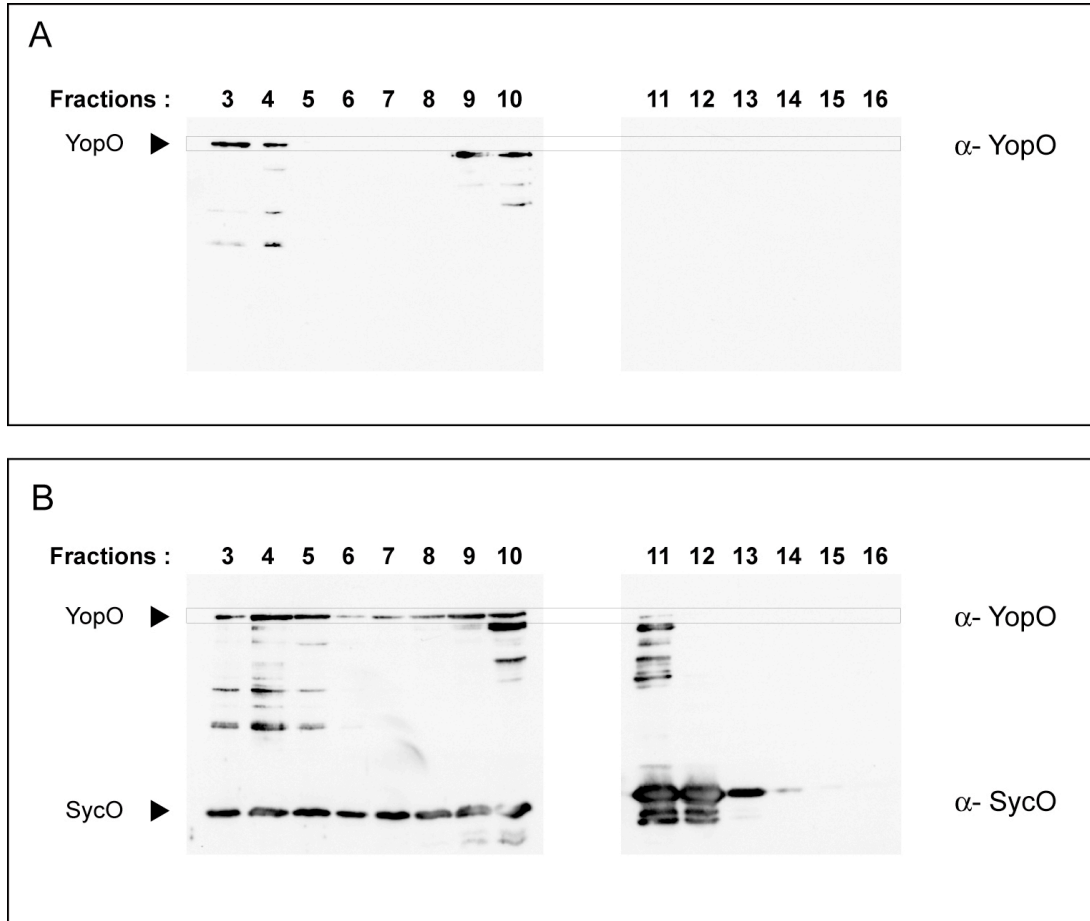

Figure 20 : *In vitro* solubilization of YopO by SycO:

Purified YopO was loaded on a Superdex 200 PC 3.2/30 and eluted by size exclusion chromatography. YopO alone eluted in fractions 3 and 4 corresponding to the void volume (Fig. 20A). YopO is aggregated. When previously incubated with SycO, part of YopO was still aggregated and eluted around fraction 4, but some tailing appeared and some YopO eluted in the fraction 9 – 10 (Fig. 20B), where the YopO_{his}-SycO complex has been shown to elute. Part of the injected YopO was solubilized by the chaperone.

Deletion of *sycO* by allelic exchange : (Fig. 21)

The region containing *sycO* was amplified by PCR from 250 bp upstream, until 250 bp downstream the gene using primers 3266/3267. The PCR product was digested by *Sall* and *XbaI*, loaded and purified on agarose gel and ligated into pBluescript KS vector giving pML18. The whole *sycO* gene was deleted from the start until the stop codon by inverted PCR on pML18 using primers 3272/3273. The PCR product was incubated with 1 μ l *DpnI* for 3 hours at 37 °C to digest the template pML18. After purification on agarose gel, the product was ligated overnight at 16°C and transformed into *E. coli* Top10, producing the plasmid pML19.

The insert containing the mutated region of *sycO* was extracted from pML19 by *Sall/XbaI* digestion and ligated into the plasmid pKNG101 giving pML20. This mutator plasmid was transferred from an *E. coli* SM10 donor strain to *Yersinia enterocolitica* MRS40 by conjugation. After propagation, *sycO* mutants were screened by colony PCR using primers specific for the WT 3251/3267 and for the mutant 3266/3267 alleles (Fig. 21D).

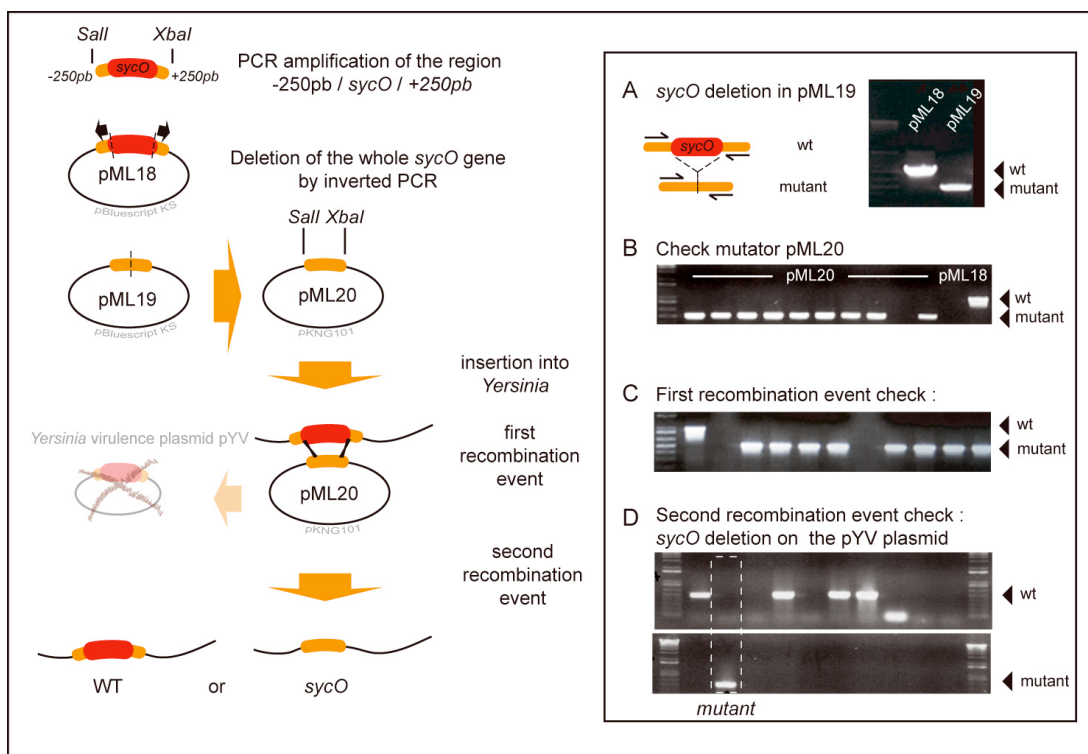

Figure 21 : Construction of the *sycO* mutant by allelic exchange.

The *sycO* gene was amplified from 250 bp upstream until 250 bp downstream and inserted in the pBluescript KS giving pML18. PCR amplification of the whole *sycO* gene from the pML18 is shown in (A) on the wt level. The *sycO* gene was deleted from the start to the stop codon by inverted PCR. Only the flanking regions of *sycO* are left in the plasmid pML19, (A) on the mutant level. This fragment was subcloned in the suicide vector pKNG101 resulting in pML20, checked in (B). After conjugation, the first recombination event was detected by colony PCR (C). Just the lower band of the mutant appears. After propagation, the second recombination event can lead to the mutant or revert back to the wild type. (D) The colonies were checked by PCR using oligonucleotides specific for the wild type (wt) or the *sycO* mutant (mutant).

Analysis of the *sycO* mutant phenotype by in vitro secretion (Fig. 22) :

We tested the requirement of SycO for the secretion of effectors *in vitro* in calcium deprived medium. We compared the patterns of proteins secreted by different *Yersinia enterocolitica* strains: WT MRS40, *sycO*, *sycO* complemented with a low copy plasmid containing the *sycO* gene with its own promoter (pML4), and a *yopO* mutant. The precipitated supernatants were separated by SDS-PAGE. The gels were either stained with Coomassie blue, (Figure 22A) or analysed by western-blot using α - YopO, α - YopP or α - SycO antibodies (Figure 22B).

The secretion of YopO was reduced in the absence of SycO. When SycO was brought in *trans* via pML4, the secretion of YopO increased compared to the *sycO* strain. Apparently, SycO is required for an efficient secretion of YopO. On the western-blot, the band corresponding to SycO in this lane migrated higher. Several versions of SycO exist with variations in the C-terminal sequences. Here we cloned a version from the virulence plasmid pYVe22703 with an additional TQS repeat at the end of the protein compared to the MRS40 version. This feature may confer different migration properties to SycO.

The *yopO* and *yopP* genes are encoded downstream *sycO*. The secretion of YopP was not modified by the absence of SycO demonstrating that the *sycO* mutation is not polar and doesn't affect YopP (Fig. 2B). Except for YopO, the secretion pattern was the same in all strains (Fig. 22A). None of the other Yops was affected by the lack of SycO. To confirm this observation, we checked the secretion of the other Yops by western blot using Cya fusions under the *yopE* promoter (Figure 22). Again, except for YopO, the secretion of no other Yop was disturbed in the *sycO* mutant bacteria.

The use of the *in vitro* secretion assay to determine the *sycO* phenotype, as well as the mild effect of *sycO* deletion on the secretion pattern prevented the discovery of SycO as the chaperone of YopO for almost 10 years. This observation brings to consider the limits of *in vitro* secretion assays.

Secretion of Yop -Cya hybrid proteins (Fig. 23) :

The N-terminal part of the Yop effectors was fused to the calmodulin dependent adenylate cyclase (Cya) from *Bordetella pertussis*, used as a reporter protein. All fusions were inserted downstream the *yopE* promoter. The different strains were incubated in condition inducing *in vitro* secretion as described above. The deletion of *sycO* had an effect only on the

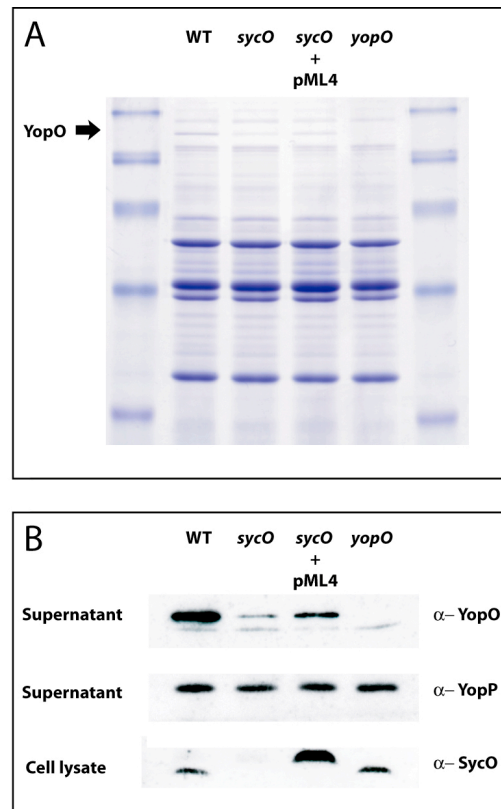

Figure 22 : Phenotype of the *sycO* mutant checked by *in vitro* secretion.

The secretion patterns of different *Yersinia enterocolitica* strains: WT MRS40, *sycO*, *sycO* complemented with a low copy plasmid containing the *sycO* gene upon his own promoter (pML4), and a *yopO* mutant were compared. Bacteria were incubated in secretive conditions for 3 hours. Supernatant were precipitated and analysed by Coomassie stained SDS PAGE, (Fig. 22A) or by westernblot using α -YopO, α -YopP or α -SycO antibodies (Fig. 22B). Comparing the secretion patterns of the WT and *sycO* strain, we see that the secretion of YopO is decreased in the absence of SycO. SycO brought in *trans* via pML4 could improve the secretion of YopO in the *sycO* mutant. SycO expressed from pML4 migrates higher. Several versions of *sycO* exist with different C-term sequences. Here a version from the pYVe22703 with an additional TQS repeat at the end of the protein was cloned, conferring different migration properties. Yops other than YopO are not affected by the deletion of *sycO* (Fig. 22A). YopO and YopP are encoded downstream *sycO*. The secretion of YopP is not modified in the *sycO* mutant. The *sycO* mutation is not polar and doesn't affect YopP.

secretion of YopO₁₄₃-CYA (reduced), not on the other Yops hybrids (Fig. 23). Since *yopO*₁₄₃-*cya* is controlled by the *yopE* promoter, *sycO* plays a role in the secretion process, not at the transcriptional level. The decrease of YopO secretion in the *sycO* mutant bacteria cannot be due to a polar effect, as *yopO*₁₄₃-*cya* is encoded on a plasmid. The deletion of *sycO* has no impact on the secretion of YopP₉₉-Cya. Although *sycO* and *yopP* are encoded in the same operon, SycO is probably not a chaperone for YopP.

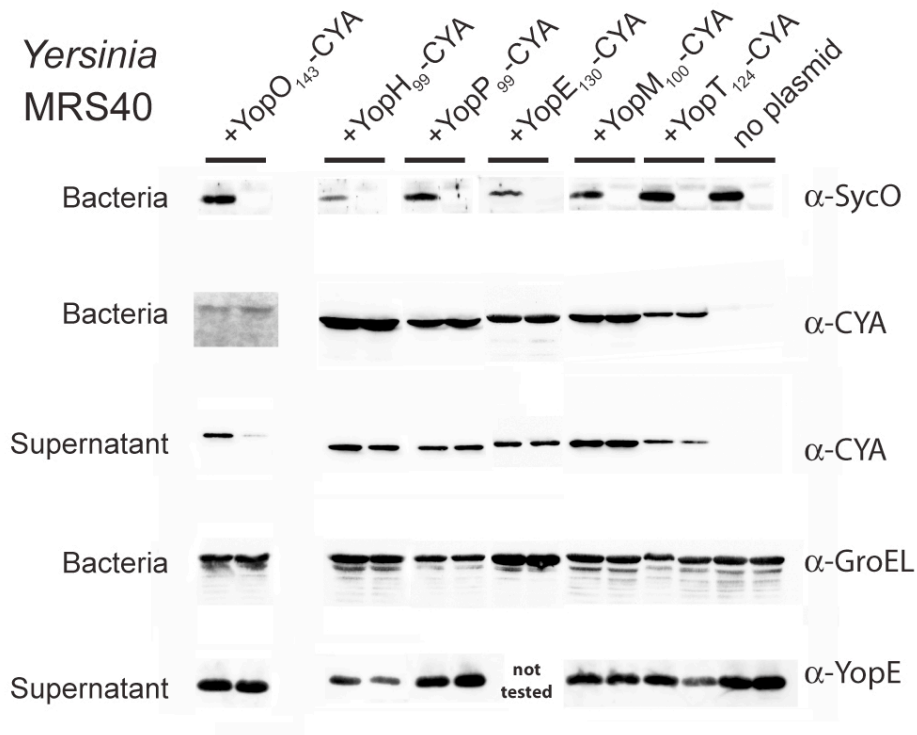

Figure 23 : *In vitro* secretion of Yop-Cya fusions by *Yersinia* MRS40 wild-type and *sycO*:

YopO₁₄₃-Cya, YopH₉₉-Cya, YopP₉₉-Cya, YopE₁₃₀-Cya, YopM₁₀₀-Cya and YopT₁₂₄-Cya were expressed in *Yersinia* MRS40 wild-type and *sycO* from pCD10, pMSLH99, pMSK3, pMSL28, pAB6 and pAB29 respectively. Bacteria were incubated in secretive conditions for 3 hours. Supernatants were precipitated and analysed by SDS PAGE and by western-blot using α-SycO, α-Cya, α-GroEL and α-YopE antibodies.

Stability of *YopO_{flag}* and *YopO_{20-77 flag}* in *Yersinia MRS40* and *sycO* (Fig. 24) :

We investigated if SycO could stabilize YopO in the bacterial cell. We expressed *YopO_{flag}* from pISO56 and *YopO_{Δ20-77flag}* from pML16 in the *Yersinia MRS40* wild type or in the *sycO* mutant. Bacteria were grown in BHI Ca^{2+} (5 mM) for 2 hours at 28 °C. The presence of Ca^{2+} prevents the release of the Yops into the supernatant. The cultures were shifted to 37 °C for 2 hours. Chloramphenicol (20 μg/ml final) was added to the test cultures in order to stop protein synthesis and samples were taken at different time points. The bacterial pellets were loaded on SDS gels and analysed by western blot.

YopO_{flag} was still present in the cell after 60 minutes in the wt, but not in the *sycO* mutant (Fig. 24A). Already after 5 minutes we could observe a strong difference comparing the *YopO_{flag}* level in the two strains. Apparently YopO was more stable in the presence of SycO. When repeated, this experiment showed less stability difference between the wild-type and the *sycO* mutant. This invites to handle this preliminary result with care. Interestingly, the stability of *YopO_{Δ20-77 flag}* was not affected by the absence of SycO (Fig. 24B).

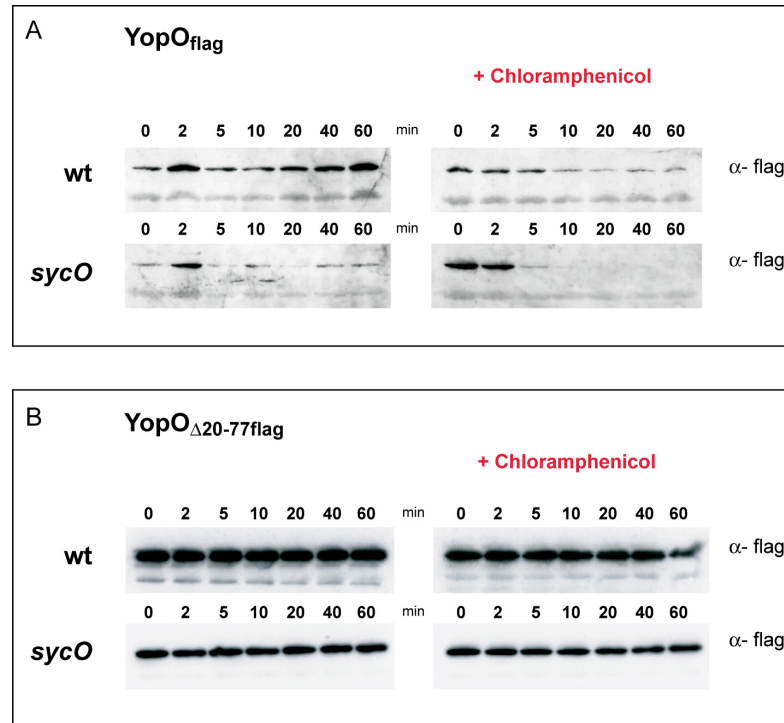

Figure 24 : Stability of *YopO_{flag}* and *YopO_{Δ20-77 flag}* in *Yersinia MRS40* and *sycO* :

YopO_{flag} (A) and *yopO_{Δ20-77 flag}* (B) were expressed in *Yersinia MRS40* wild-type and *sycO* from pISO56 and pML16 respectively. Strains were incubated in condition inducing the T3S system, but not secretion (with 5mM Ca^{2+}). Protein synthesis was stopped in the test cultures by addition of chloramphenicol. Sample were taken at different time points.

Cellular localization of YopP-EGFP and YopN-EGFP (Fig. 25) :

Yops effectors with a chaperone of the Class I contain a CBD that is involved in sub-cellular localization once the effector is delivered in the eukaryotic cell (Letzelter *et al.*, 2006). This hypothesis valid for YopO, YopE and YopT was also tested for YopP and YopN. As described previously, *yopP* and *yopN* genes fused to *egfp* were transfected into eukaryotic cells. Then the distribution of EGFP was monitored by fluorescence microscopy.

The transfected YopP in fusion with EGFP was distributed homogeneously in the cell (Fig. 25). According to our hypothesis, YopP which has no described chaperone and thus no CBD, revealed no specific localization properties. Probably YopP has no chaperone at all, or at least no chaperone of the Class I. The orphan ORFs from the virulence plasmid (pYV) are not conserved in the three pathogenic *Yersinia* species. In addition, the putative products of these ORFs do not present the expected profile of a chaperone.

YopN, does apparently contradict the emitted hypothesis. The transfected YopN fused to EGFP did not exhibit any particular localization in the cell (Fig. 25). But YopN is somehow peculiar in the Yop family and its case is described further in the general discussion of this thesis.

These analyses made by fluorescence microscopy are only preliminary studies and do not constitute a demonstration. They have to be completed by biochemical analyses like cell fractionation, solubility tests... in order to draw final conclusion.

YopT₁₂₄ -EGFP kinetic of expression after transfection (Fig. 26) :

After transfection, YopT₁₂₄ -EGFP expressed in HEK293T cells displayed a punctuated distribution. According to the poor solubility of YopT, this distribution was likely the consequence of the aggregation of the EGFP hybrid protein. We tried to monitor the distribution of YopT₁₂₄ -EGFP earlier after transfection. The aim was to observe if YopT₁₂₄ -EGFP could localize before it aggregates. We made a time course experiment, monitoring EGFP distribution 6 hours, 12 hours and 24 hours after transfection.

After 6 hours, no particular localization could be monitored and some aggregation already appeared in most of the cells. Aggregation increased at the next time points without any other localization pattern.

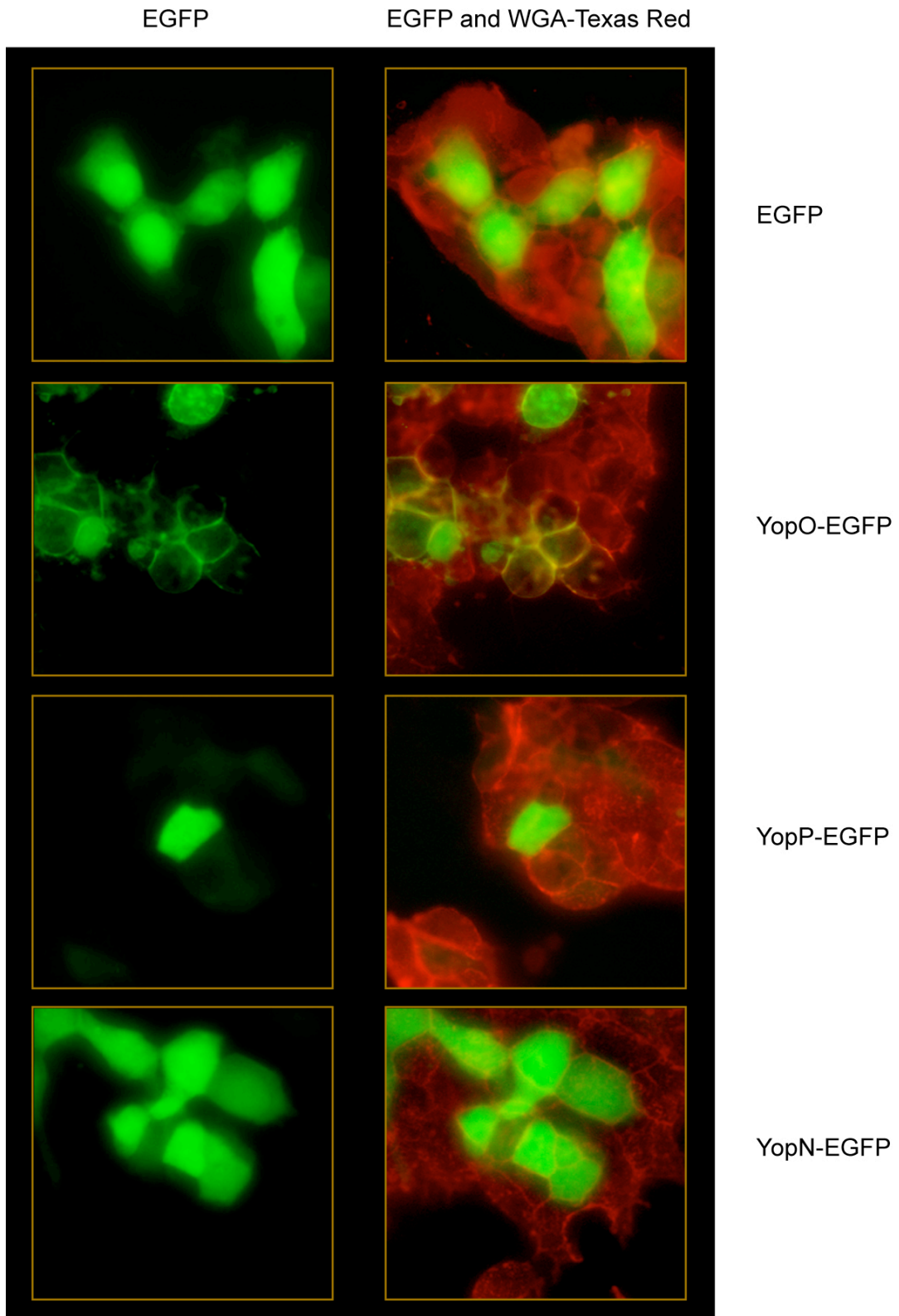

Figure 25 : Transfection of YopP-EGFP and YopN-EGFP.

YopP-egfp and *yopN-egfp* were expressed for 24 hours after transfection of HEK293T cells. Cells were stained with Texas-Red conjugated wheat germ agglutinin (membrane staining), fixed and analysed by fluorescence microscopy.

YopT₁₂₄ -EGFP

Figure 26 : Transfection of YopT₁₂₄ -EGFP, kinetic of expression :

YopT₁₂₄-egfp was expressed from pSAM12 after transfection of HEK293T cells. Cells were grown for 6, 12, or 24 hours after transfection and fixed. Pictures were acquired by confocal microscopy.

Intrabacterial solubility of YopH in the presence or in the absence of SychH (Fig. 27) :

The intrabacterial solubility of YopH was assayed as for other YopO, T and E effectors (described in Letzelter *et al.* 2006). YopO_{his}, YopT_{his} and YopE_{his} were soluble in the presence of SycO, SycT and SycE respectively. In the absence of their chaperone, they were poorly soluble. On the opposite YopH was as soluble in the presence or in the absence of SychH.

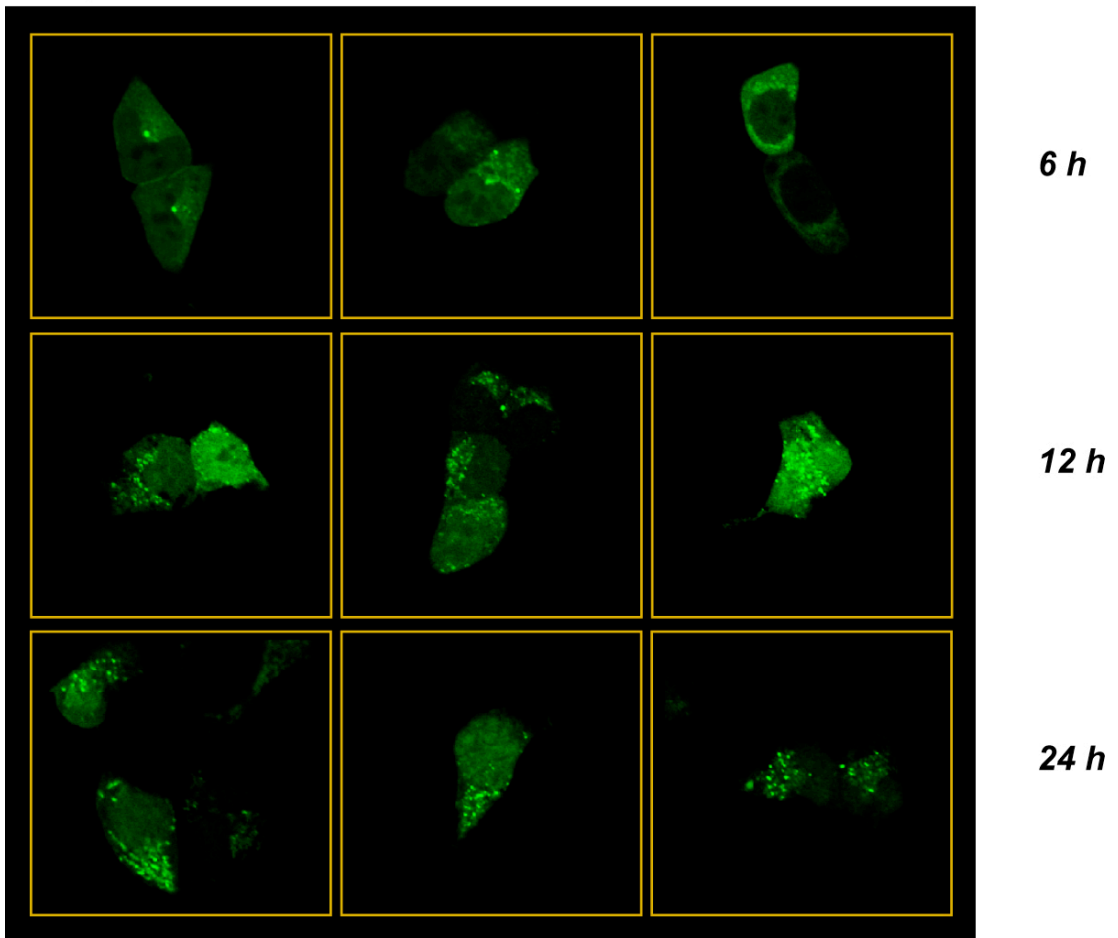
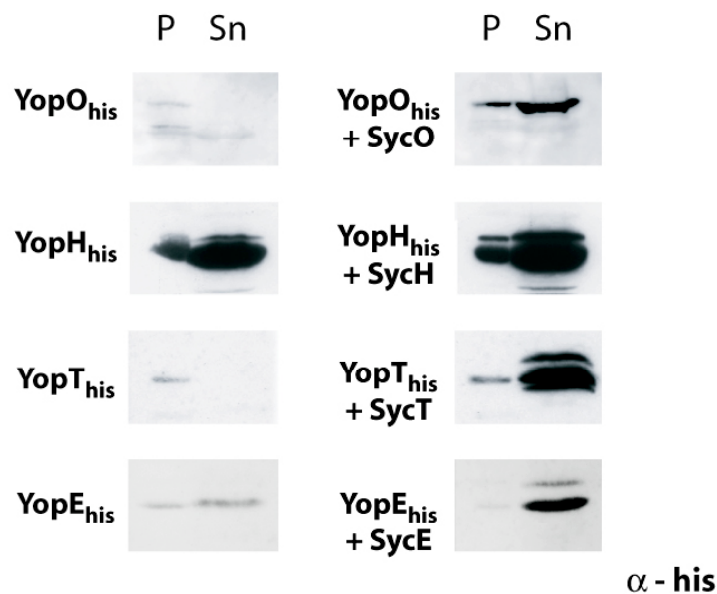

Figure 27 : Intrabacterial solubility of YopH in the presence or in the absence of SychH.

The effectors *yopO_{his}*, *yopH_{his}*, *yopT_{his}* and *yopE_{his}* were expressed in *E.coli*, respectively from pML7, pML32, pML34 and pML33 . The chaperones *sycO*, *sychH*, *sycT* and *sycE* were expressed from pML7, pSAM14, pSAM15 and pSAM13 respectively. The solubility of the proteins was determined by ultracentrifugation as described in Letzelter *et al.* 2006. Insoluble proteins are present in the pellet fraction (P), soluble proteins appear in the soluble fraction (Sn).

VII. General Discussion and Conclusions

General discussion and conclusions:

What is the function of Class I chaperones? In this study, we demonstrated that SycO is a Class I chaperone, specific for YopO. We investigated the interaction between YopO and SycO and we discovered a new function for T3S effector chaperones. Various roles have been previously attributed to Class I chaperones, like targeting, stabilization and unfolding of effectors. We will address separately these different functions and see, in each case, if such a role can be attributed to SycO.

Targeting: Do Class I chaperones constitute a secretion/translocation signal?

Chaperone knockouts usually present a deficiency to secrete their related effector. Based on such observations, one of the first roles proposed for T3S chaperones was a targeting function (Wattiau *et al.*, 1994). Investigating the N-terminal secretion signal of secreted effectors, Cheng *et al.* showed that the N-terminal secretion signal of YopE alone (YopE₁₅), fused to the Npt reporter protein allows the secretion of the hybrid protein. Expectedly, a frameshifted signal fused to the same reporter cannot be secreted (Cheng *et al.*, 1997). However, a YopE-Npt fusion, with a frameshifted secretion signal is secreted by the wild-type, but not by a *sycE* mutant bacteria. Thus, Cheng *et al.* proposed that the binding of SycE to the CBD of the YopE-Npt fusion constitutes an alternative secretion signal. Similar observations have been made by Lloyd *et al.* (Lloyd *et al.*, 2001). These authors used YopE with different frameshifts (+/-1, +/-2) in the first 13 residues of the N-terminal signal. The signal frameshifted YopE proteins were all secreted by the wild-type bacteria *in vitro*. But, they all failed to be secreted by *yerA* (*sycE*) mutant bacteria. Further, the authors replaced the N-terminal signal of YopE with artificial polar, hydrophobic or amphipathic sequences. It turned out that only a N-terminal synthetic amphipathic sequence consisting of alternating serine and isoleucine residues was secreted, both in the presence and in the absence of YerA (SycE). Neither poly-serine nor poly-isoleucine sequences permitted secretion of YopE, despite the presence of YerA (SycE). These results suggest that the N-terminal sequence of YopE is critical for secretion, even in the presence of the chaperone. Therefore, even if chaperones apparently assist the secretion of their substrate, they cannot be considered as a secretion signal on their own.

Boyd *et al.* demonstrated that a *Yersinia* poly-effector mutant (Δ HOPEMT) can translocate YopE₁₅-Cya as efficiently as YopE₁₃₀-Cya. A mutant deprived of YopH, YopE and YopT is also able to deliver YopE _{Δ 17-77}. SycE cannot bind YopE₁₅-Cya or YopE _{Δ 17-77} (Boyd *et al.*, 2000). Thus, the N-terminal signal sequence of YopE is sufficient for delivery into eukaryotic cells and SycE is dispensable for the export. The authors proposed that chaperones would actually assist the

export by helping their substrate to compete for delivery to the T3S apparatus. Indeed, However, the fact that the SycE-binding site and SycE are necessary for delivery of YopE by wild-type *Yersinia* suggested to the authors that chaperones could help effectors to compete against each other to be delivered. We made similar observations with SycO and we excluded that SycO could constitute an export signal for YopO. Indeed, YopO could be secreted by the *sycO* mutant bacteria *in vitro*. Moreover, YopO_{Δ20-77} -which cannot bind SycO- could be secreted *in vitro* by the wild-type bacteria as well as by the *sycO* mutant bacteria. During cell infection, YopO_{143 Δ20-77} (ΔCBD) fused to the Cya reporter could be translocated into host cells, but only by multi-effectors mutants (ΔHOPEMT). The fact that YopO deprived of its CBD is less efficiently translocated does not prove that the CBD and the chaperone are targeting factors. Indeed, the system adapted to the constraint that it is the YopO-SycO complex and not YopO that needs to be directed to the injectisome. In addition, the presence of the chaperone has imposed the constraint of "de-chaperonization", which was shown to be the task of the ATPase (Akeda and Galan, 2005). The consequence of this is that the targeting of YopO evolved to allow its translocation in the presence, and after displacement, of SycO. By deleting the CBD, we just have created a new secretion substrate that can be targeted, but whose signal is not optimized. As the export process can work without chaperones, we exclude that they constitute a export signal. However in the wild-type context it appears that the chaperones are necessary to the export of their substrate. How are Class I chaperones involved in the export of their substrate? We showed that YopO could be secreted *in vitro* by the *sycO* mutant. However, during cell infection, no YopO is translocated into the host cells by the chaperone knockout. We did not investigate the reasons for the differences observed between Ca²⁺-chelation mediated secretion and contact-mediated translocation, but these two events must involve mechanistically distinct processes. *In vitro* secretion is a 3 to 4 hours incubation of the bacteria in conditions where T3S is deregulated and secretes continuously, whereas translocation into eukaryotic cells is a fast process. In *Shigella*, half of the pool of pre-synthesized effectors is released within the 250 seconds following contact (Enninga *et al.*, 2005). Previous studies in *Shigella* showed that secretion of IpaA in the absence of the chaperone Spa15 could occur *in vitro* in a co-translational way. However, the first burst of secretion observed (first 30 minutes) was strictly post-translational and chaperone dependent (Page *et al.*, 2002). Our results also suggest that secretion in Ca²⁺-deprivation conditions might occur both, by post-translational and co-translational mechanisms, while contact-mediated translocation is probably exclusively post-translational. Thus, our data fit very well with the idea that the chaperone would be required for export of pre-synthesized YopO and not for export of YopO synthesized while secretion is active. This constraint implies that chaperones are involved in the storage of effectors. This suggestion is in accordance with our solubility studies. In the absence of their chaperones YopO, YopE and YopT aggregate in the bacteria. This state is not suitable for the uptake of the proteins by the T3S. Thus, chaperones keep their substrate soluble and fit for export.

Structural data were also analyzed to determine what could be the role of chaperones in targeting. Comparing the structure the YopE-SycE complex with the SptP-SicP complex of *Salmonella*, Birtalan *et al.* observed strong structural similarities. These authors proposed that effectors in complex with the chaperones would constitute a three-dimensional signal (Birtalan *et al.*, 2002). However, recent studies including additional new complexes like YopN-SycN-YscB (Schubot *et al.*, 2005) or SicA-InvB (Lilic *et al.*, 2006) revealed sufficient structural diversity between the complexes to discard the idea of a conserved three dimensional signal (Lilic *et al.*, 2006). Nevertheless, Lilic *et al.* adapted another hypothesis proposed previously by Birtalan *et al.* where chaperones “prime the secretion”. Chaperones would keep the CBD segment of polypeptide unfolded in a “secretion competent state”. By this mechanism the chaperone could help the recognition process by presenting the N-terminal secretion signal to the apparatus, by promoting the interaction with the ATPase and facilitating the unfolding of the effector as demonstrated by Akeda and Galan (Akeda and Galan, 2005).

Stabilization: Are Class I chaperones stabilizing their substrate?

Several Class I chaperones are stabilizing their associated effector. It has been demonstrated for the chaperone-effector complex SycE-YopE (Frithz-Lindsten *et al.*, 1995), SicP-SptP (Fu and Galan, 1998) and IpgE-IpgD (Niebuhr *et al.*, 2000). The stability kinetics of YopO in the wild-type and the *sycO* mutant were similar. SycO could apparently stabilize YopO inside the bacteria (*cf.* unpublished results). However as we mentioned before, these preliminary experiments should be confirmed.

YopO (Letzelter *et al.*, 2006), YopE (Frithz-Lindsten *et al.*, 1995), SptP (Fu and Galan, 1998), Tir (Abe *et al.*, 1999), IpgD (Niebuhr *et al.*, 2000), are all present at a lower level in the absence of their chaperone. This might be the result of a lower stability and a decrease in the amount of protein. Our data bring some arguments to explain this instability. Indeed, we observed that the CBD of the effectors is aggregation prone and has to be covered by the chaperone. In the absence of the chaperone, YopO, YopE or YopT aggregate. This protein state is not suitable for the bacteria and aggregates are subjected to proteolysis. In contrast to the aforementioned effectors, some others like YopH (Wattiau *et al.*, 1994) or IpaA (Page *et al.*, 2002) are stable in the absence of their chaperone. Accordingly, YopH is as soluble with or without its chaperone (Fig. 27).

Folding: Do Class I chaperones keep their effectors unfolded?

The idea that T3S chaperone keep their substrate completely unfolded can be definitely discarded. CBDs wrap around chaperones dimers in an extended conformation, with no or little secondary structure. However, it is now established that the uncovered part of the effectors is folded. This appears directly on the crystal structures of chaperone effector complexes like InvB-SipA (Lilic *et al.*, 2006), SycN-YscB-YopN (Schubot *et al.*, 2005). In addition, effectors like YopE (Birtalan *et al.*, 2002), YopH (Neumayer *et al.*, 2004) and YopO (Letzelter *et al.*, 2006) were shown to keep their enzymatic activity in complex with their chaperone. These observations not only discard the possibility that chaperones keep their substrate completely unfolded, but also pinpoint another interesting fact. The CBD is not required for the catalytic activity of the protein. We confirmed this observation by removing the CBD from YopO. Therefore, if the chaperone and the CBD do not constitute a secretion signal and are not needed for the catalytic activity of the protein, why would the system conserve such aggregation prone CBDs?

Localization: Are CBDs membrane / sub-cellular localization domain?

The CBD apparently creates the need for the chaperone. But, as mentioned by Birtalan *et al.*, it is unlikely that chaperones exist simply to mask an aggregation-prone effector domain whose only function is chaperone binding (Birtalan *et al.*, 2002). Strikingly, in *Yersinia* all the effectors having a chaperone have an activity on the actin cytoskeleton dynamics and are targeted to the host cell membrane. Accordingly to our data, the CBD would play a role within the target cell, once the effector is delivered. Indeed, the CBD of YopO overlaps a membrane localization domain. Fused to EGFP this small region of YopO is sufficient to bring EGFP to the plasma membrane of the eukaryotic cell. Thus, the CBD of YopO is an aggregation prone membrane localization domain. By covering this domain, SycO prevents the aggregation of YopO and allows its export.

What about other *Yersinia* effectors? The CBD of YopE and more precisely the residues 50-77 were shown to be “toxic” for *Yersinia* and to prevent secretion of YopE in the absence of the chaperone SycE (Boyd *et al.*, 2000). Purified YopE was shown to aggregate (Birtalan *et al.*, 2002). The addition of SycE, covering these residues (15 to 75), promotes the solubilization of the effector (Birtalan *et al.*, 2002); (Letzelter *et al.*, 2006). In the eukaryotic cell, residues 54-75 of YopE were shown to be a membrane localization domain (Krall *et al.*, 2004). Thus, the situation is identical to YopO: SycE covers a membrane localization domain on YopE and keeps it in a soluble state, suitable for export. Without SycT, YopT is also insoluble in *E.coli* (Letzelter

et al., 2006). Translocated YopT has also been shown to localize to HeLa cell membranes (Aepfelbacher *et al.*, 2003). Concerning YopH, the situation is a bit more complex, as its CBD partially overlaps the phosphotyrosine recognition domain (Montagna *et al.*, 2001). YopH has been shown to interact with focal adhesions (Persson *et al.*, 1999) and other membrane complexes (Black *et al.*, 2000). Different domains of YopH, including its CBD, are involved in interactions with the Fyn binding protein in macrophages (Yuan *et al.*, 2005). Even though, the CBD of YopH is not a membrane-targeting domain, it is also involved in sub-cellular localization. However, YopN may not follow our hypothesis. YopN is quite unique in the Yop family. Although it has two chaperones of the Class I, SycN (Iriarte and Cornelis, 1999b) and YscB (Day and Plano, 1998), it is the only heterodimeric chaperone complex described. Contrary to what was reported before (Boland *et al.*, 1996), YopN has been showed to be translocated into host cells (Cheng *et al.*, 2001; Day *et al.*, 2003). We observed that ectopically produced YopN-EGFP does not go to the eukaryotic cell membrane. No other study addressed the question of intracellular localization of YopN. Beside, YopN acts as a regulator of T3S (Ferracci *et al.*, 2005; Forsberg *et al.*, 1991) and it has never been suggested to be an effector, what could explain why YopN would not need a sub-cellular localization domain. This translocation could just be the way the system eliminates a regulator when it is not needed anymore. However, YopN could also be a bi-functional protein with one function in the bacterial cell (control) and one function in the host cell (effector). Thus, one should test whether YopN is addressed to the membrane using other approaches.

YopM and YopP/YopJ, in contrast are not targeted to membranes. YopM is migrating to the nucleus (Benabdillah *et al.*, 2004), and YopP/YopJ interacts with the MAP kinase pathway in the cytosol (Orth, 2002). In agreement with our hypothesis, no specific chaperone was found for them so far. There is almost no possibility to discover an additional chaperone for those two effectors. One of the last *orf* from the *Yersinia* virulence plasmid (pYV) called *orf155* turned out to be *sycO* encoding the chaperone for YopO. Among the few *orfs* left, none presents the potential to be a Class I chaperone. Either their sequence is too short and does not present the characteristics of Class I chaperones, or they are not conserved in the three pathogenic species (*Y. enterocolitica*, *Y. pseudotuberculosis*, *Y. pestis*).

Our hypothesis about chaperones covering a targeting domain could apply to chaperones of effectors of other T3S systems. The best characterized effectors with a dedicated chaperone, have an activity related to membranes. In *Salmonella*, SptP, SigD/SopB and SopE, SopE2, SipA all have a Class I chaperone (SicP, SigE and InvB, respectively) and have been shown to be membrane associated (Cain *et al.*, 2004); (Norris *et al.*, 1998). In *Shigella*, IpaA one of Spa15 substrates contributes to the entry of the bacteria into cells by binding the focal adhesion protein vinculin (Tran Van Nhieu *et al.*, 2000). Finally, in enteropathogenic *E. coli* (EPEC), Tir is the membrane associated intimin receptor and the effector Map (Mitochondria associated

protein) was shown to act at the mitochondrial membrane level (Kenny and Jepson, 2000). Both effectors have CesT for chaperone (Creasey *et al.*, 2003).

Generally, there is a correlation between the presence of a chaperone and an activity of the effector at the membrane of the target cell. Every domain might not be aggregation prone, but could also generate a problem for T3S targeting, creating the need for the chaperone. Also, the nature of the interaction between the “membrane localization domain” and the membrane itself is not known. Since chaperone binding domains present hydrophobic patches to interact with the chaperones and have a tendency to aggregate, they could have a direct affinity for the lipids of the membrane. However, they could also be protein-protein interaction domains, binding membrane-associated components. To take a broader view, we could propose that Class I chaperones need to cover domains that are involved in sub-cellular localization of the effector in the target cell.

VIII. Outlooks

Outlooks :

We demonstrated that the CBD of YopO, YopE and probably YopT is an aggregation prone membrane localization domain. In consistency with the literature, we propose that covering such domain inside the bacterium would be a common role for type three effector chaperones.

In general, this hypothesis should be challenged with other effectors and T3S systems to see if other CBDs are membrane or sub-cellular localization domains. Several questions were raised by our study.

How are the CBDs targeted to eukaryotic membranes ?

- What is the nature of the interaction between the CBD and the eukaryotic membranes: Protein-protein interactions, direct interaction with the lipids, post-translational modifications?
- Which motifs or residues are involved in the targeting to the membrane?
- Are those residues the same as those involved in the intra-bacterial aggregation?

To understand the whole process of T3S, we could also further investigate the function of the chaperone and the CBD inside the bacterium:

- Are CBDs folded in the absence of the chaperone as it is the case for the CBD of YopH? (Evdokimov *et al.*, 2001)
- Does this folding lead to the masking of the secretion signal as it could be the case for YopH?
- Which elements of the chaperones or the chaperones-effector complexes are involved in the interaction with the ATPase?

IX. References

Literature:

- Abe, A., Grado, M.d., Pfuetzner, R., Sanchez-Sanmartin, C., Devinney, R., Puente, J., Strynadka, N., and Finlay, B. (1999) Enteropathogenic *Escherichia coli* translocated intimin receptor, Tir, requires a specific chaperone for stable secretion. *Mol Microbiol* **33**: 1162-1175.
- Aepfelbacher, M., Trasak, C., Wilharm, G., Wiedemann, A., Trulzsch, K., Krauss, K., Gierschik, P., and Heesemann, J. (2003) Characterization of YopT effects on Rho GTPases in *Yersinia enterocolitica*-infected cells. *J Biol Chem* **278**: 33217-33223.
- Akeda, Y., and Galan, J.E. (2005) Chaperone release and unfolding of substrates in type III secretion. *Nature* **437**: 911-915.
- Altschul, S.F., Madden, T.L., Schaffer, A.A., Zhang, J., Zhang, Z., Miller, W., and Lipman, D.J. (1997) Gapped BLAST and PSI-BLAST: a new generation of protein database search programs. *Nucleic Acids Res* **25**: 3389-3402.
- Anderson, D.M., Ramamurthi, K.S., Tam, C., and Schneewind, O. (2002) YopD and LcrH regulate expression of *Yersinia enterocolitica* YopQ by a posttranscriptional mechanism and bind to yopQ RNA. *J Bacteriol* **184**: 1287-1295.
- Auvray, F., Thomas, J., Fraser, G.M., and Hughes, C. (2001) Flagellin polymerisation control by a cytosolic export chaperone. *J Mol Biol* **308**: 221-229.
- Benabdillah, R., Mota, L.J., Lutzelschwab, S., Demoinet, E., and Cornelis, G.R. (2004) Identification of a nuclear targeting signal in YopM from *Yersinia* spp. *Microb Pathog* **36**: 247-261.
- Bergman, T., Hakansson, S., Forsberg, A., Norlander, L., Macellaro, A., Backman, A., Bolin, I., and Wolf-Watz, H. (1991) Analysis of the V antigen lcrGVH-yopBD operon of *Yersinia pseudotuberculosis*: evidence for a regulatory role of LcrH and LcrV. *J Bacteriol* **173**: 1607-1616.
- Birtalan, S., and Ghosh, P. (2001) Structure of the *Yersinia* type III secretory system chaperone SycE. *Nat Struct Biol* **8**: 974-978.
- Birtalan, S.C., Phillips, R.M., and Ghosh, P. (2002) Three-dimensional secretion signals in chaperone-effector complexes of bacterial pathogens. *Mol Cell* **9**: 971-980.
- Black, D.S., Marie-Cardine, A., Schraven, B., and Bliska, J.B. (2000) The *Yersinia* tyrosine phosphatase YopH targets a novel adhesion-regulated signalling complex in macrophages. *Cell Microbiol* **2**: 401-414.
- Blocker, A., Jouihri, N., Larquet, E., Gounon, P., Ebel, F., Parsot, C., Sansonetti, P., and Allaoui, A. (2001) Structure and composition of the *Shigella flexneri* "needle complex", a part of its type III secretion. *Mol Microbiol* **39**: 652-663.
- Boland, A., Sory, M.P., Iriarte, M., Kerbourch, C., Wattiau, P., and Cornelis, G.R. (1996) Status of YopM and YopN in the *Yersinia* Yop virulon: YopM of *Y. enterocolitica* is internalized inside the cytosol of PU5-1.8 macrophages by the YopB, D, N delivery apparatus. *Embo J* **15**: 5191-5201.
- Boyd, A.P., Lambermont, I., and Cornelis, G.R. (2000) Competition between the Yops of *Yersinia enterocolitica* for delivery into eukaryotic cells: role of the SycE chaperone binding domain of YopE. *J Bacteriol* **182**: 4811-4821.
- Buttner, C.R., Cornelis, G.R., Heinz, D.W., and Niemann, H.H. (2005) Crystal structure of *Yersinia enterocolitica* type III secretion chaperone SycT. *Protein Sci* **14**: 1993-2002.
- Cain, R.J., Hayward, R.D., and Koronakis, V. (2004) The target cell plasma membrane is a critical interface for *Salmonella* cell entry effector-host interplay. *Mol Microbiol* **54**: 887-904.
- Callebaut, I., Labesse, G., Durand, P., Poupon, A., Canard, L., Chomilier, J., Henrissat, B., and Mornon, J.P. (1997) Deciphering protein sequence information through hydrophobic cluster analysis (HCA): current status and perspectives. *Cell Mol Life Sci* **53**: 621-645.
- Cambronne, E.D., Cheng, L.W., and Schneewind, O. (2000) LcrQ/YscM1, regulators of the *Yersinia* yop virulon, are injected into host cells by a chaperone-dependent mechanism. *Mol Microbiol* **37**: 263-273.
- Cheng, L.W., Anderson, D.M., and Schneewind, O. (1997) Two independent type III secretion mechanisms for YopE in *Yersinia enterocolitica*. *Mol Microbiol* **24**: 757-765.
- Cheng, L.W., Kay, O., and Schneewind, O. (2001) Regulated secretion of YopN by the type III machinery of *Yersinia enterocolitica*. *J Bacteriol* **183**: 5293-5301.
- Cornelis, G., Sory, M.P., Laroche, Y., and Derclaye, I. (1986) Genetic analysis of the plasmid region controlling virulence in *Yersinia enterocolitica* 0:9 by Mini-Mu insertions and lac gene fusions. *Microb Pathog* **1**: 349-359.

- Creasey, E.A., Delahay, R.M., Bishop, A.A., Shaw, R.K., Kenny, B., Knutton, S., and Frankel, G. (2003) CesT is a bivalent enteropathogenic *Escherichia coli* chaperone required for translocation of both Tir and Map. *Mol Microbiol* **47**: 209-221.
- Darwin, K., and Miller, V. (2000) The putative invasion protein chaperone SicA acts together with InvF to activate the expression of *Salmonella typhimurium* virulence genes. *Mol Microbiol* **35**: 949-960.
- Darwin, K.H., and Miller, V.L. (2001) Type III secretion chaperone-dependent regulation: activation of virulence genes by SicA and InvF in *Salmonella typhimurium*. *Embo J* **20**: 1850-1862.
- Day, J.B., and Plano, G.V. (1998) A complex composed of SycN and YscB functions as a specific chaperone for YopN in *Yersinia pestis*. *Mol Microbiol* **30**: 777-788.
- Day, J.B., Ferracci, F., and Plano, G.V. (2003) Translocation of YopE and YopN into eukaryotic cells by *Yersinia pestis* yopN, tyeA, sycN, yscB and lcrG deletion mutants measured using a phosphorylatable peptide tag and phosphospecific antibodies. *Mol Microbiol* **47**: 807-823.
- Driessen, A.J. (2001) SecB, a molecular chaperone with two faces. *Trends Microbiol.* **9**: 193-196.
- Edqvist, P.J., Broms, J.E., Betts, H.J., Forsberg, A., Pallen, M.J., and Francis, M.S. (2006) Tetratricopeptide repeats in the type III secretion chaperone, LcrH: their role in substrate binding and secretion. *Mol Microbiol* **59**: 31-44.
- Ehrbar, K., Friebel, A., Miller, S.I., and Hardt, W.D. (2003) Role of the *Salmonella* pathogenicity island 1 (SPI-1) protein InvB in type III secretion of SopE and SopE2, two *Salmonella* effector proteins encoded outside of SPI-1. *J Bacteriol* **185**: 6950-6967.
- Ehrbar, K., Winnen, B., and Hardt, W. (2006) The chaperone binding domain of SopE inhibits transport via flagellar and SPI-1 TTSS in the absence of InvB. *Mol Microbiol* **59**: 248-264.
- Enninga, J., Mounier, J., Sansonetti, P., and Tran Van Nhieu, G. (2005) Secretion of type III effectors into host cells in real time. *Nat Methods* **2**: 959-965.
- Evdokimov, A.G., Phan, J., Tropea, J.E., Routzahn, K.M., Peters, H.K., Pokross, M., and Waugh, D.S. (2003) Similar modes of polypeptide recognition by export chaperones in flagellar biosynthesis and type III secretion. *Nat Struct Biol* **10**: 789-793.
- Feldman, M.F., Muller, S., Wuest, E., and Cornelis, G.R. (2002) SycE allows secretion of YopE-DHFR hybrids by the *Yersinia enterocolitica* type III Ysc system. *Mol Microbiol* **46**: 1183-1197.
- Fenton, W.A., and Horwich, A.L. (2003) Chaperonin-mediated protein folding: fate of substrate polypeptide. *Quarterly Reviews of Biophysics* **36**: 229-256.
- Ferracci, F., Schubot, F.D., Waugh, D.S., and Plano, G.V. (2005) Selection and characterization of *Yersinia pestis* YopN mutants that constitutively block Yop secretion. *Mol Microbiol* **57**: 970-987.
- Forsberg, A., and Wolf-Watz, H. (1990) Genetic analysis of the yopE region of *Yersinia* spp.: identification of a novel conserved locus, yerA, regulating yopE expression. *J Bacteriol* **172**: 1547-1555.
- Forsberg, A., Viitanen, A.M., Skurnik, M., and Wolf-Watz, H. (1991) The surface-located YopN protein is involved in calcium signal transduction in *Yersinia pseudotuberculosis*. *Mol Microbiol* **5**: 977-986.
- Francis, M.S., Lloyd, S.A., and Wolf-Watz, H. (2001) The type III secretion chaperone LcrH cooperates with YopD to establish a negative, regulatory loop for control of Yop synthesis in *Yersinia pseudotuberculosis*. *Mol Microbiol* **42**: 1075-1093.
- Fraser, G.M., Bennett, J.C., and Hughes, C. (1999) Substrate-specific binding of hook-associated proteins by FlgN and FliT, putative chaperones for flagellum assembly. *Mol Microbiol* **32**: 569-580.
- Frithz-Lindsten, E., Rosqvist, R., Johansson, L., and Forsberg, A. (1995) The chaperone-like protein YerA of *Yersinia pseudotuberculosis* stabilizes YopE in the cytoplasm but is dispensable for targeting to the secretion loci. *Mol Microbiol* **16**: 635-647.
- Fu, Y., and Galan, J.E. (1998) Identification of a specific chaperone for SptP, a substrate of the centisome 63 type III secretion system of *Salmonella typhimurium*. *J Bacteriol* **180**: 3393-3399.
- Gophna, U., Ron, E.Z., and Graur, D. (2003) Bacterial type III secretion systems are ancient and evolved by multiple horizontal-transfer events. *Gene* **312**: 151-163.

- Iriarte, M., and Cornelis, G.R. (1998) YopT, a new Yersinia Yop effector protein, affects the cytoskeleton of host cells. *Mol Microbiol* **29**: 915-929.
- Iriarte, M., and Cornelis, G. (1999a) The 70 kb Yersinia Virulence Plasmid. In *Pathogenicity Islands and Other Mobile Virulence Elements*. J., H. (ed). Washington D.C: ASM Press, pp. 91-126.
- Iriarte, M., and Cornelis, G.R. (1999b) Identification of SycN, YscX, and YscY, three new elements of the Yersinia yop virulon. *J Bacteriol* **181**: 675-680.
- Jackson, M.W., Day, J.B., and Plano, G.V. (1998) YscB of Yersinia pestis functions as a specific chaperone for YopN. *J Bacteriol* **180**: 4912-4921.
- Kaniga, K., Delor, I., and Cornelis, G.R. (1991) A wide-host-range suicide vector for improving reverse genetics in gram-negative bacteria: inactivation of the blaA gene of Yersinia enterocolitica. *Gene* **109**: 137-141.
- Kelley, L.A., MacCallum, R.M., and Sternberg, M.J. (2000) Enhanced genome annotation using structural profiles in the program 3D-PSSM. *J Mol Biol* **299**: 499-520.
- Kenny, B., and Jepson, M. (2000) Targeting of an enteropathogenic Escherichia coli (EPEC) effector protein to host mitochondria. *Cell Microbiol* **2**: 579-590.
- Kovach, M.E., Elzer, P.H., Hill, D.S., Robertson, G.T., Farris, M.A., Roop, R.M., 2nd, and Peterson, K.M. (1995) Four new derivatives of the broad-host-range cloning vector pBBR1MCS, carrying different antibiotic-resistance cassettes. *Gene* **166**: 175-176.
- Krall, R., Zhang, Y., and Barbieri, J.T. (2004) Intracellular membrane localization of pseudomonas ExoS and Yersinia YopE in mammalian cells. *J Biol Chem* **279**: 2747-2753.
- Kubori, T., Matsushima, Y., Nakamura, D., Uralil, J., Lara-Tejero, M., Sukhan, A., Galan, J.E., and Aizawa, S.I. (1998) Supramolecular structure of the Salmonella typhimurium type III protein secretion system. *Science* **280**: 602-605.
- Lee, S.H., and Galan, J.E. (2003) InvB is a type III secretion-associated chaperone for the Salmonella enterica effector protein SopE. *J Bacteriol* **185**: 7279-7284.
- Lee, S.H., and Galan, J.E. (2004) Salmonella type III secretion-associated chaperones confer secretion-pathway specificity. *Mol Microbiol* **51**: 483-495.
- Letzelter, M., Sorg, I., Mota, L.J., Meyer, S., Stalder, J., Feldman, M., Kuhn, M., Callebaut, I., and Cornelis, G.R. (2006) The discovery of SycO highlights a new function for type III secretion effector chaperones. *Embo J*.
- Lilic, M., Vujanac, M., and CE, C.S. (2006) A common structural motif in the binding of virulence factors to bacterial secretion chaperones. *Mol Cell* **21**: 653-664.
- Lloyd, S.A., Norman, M., Rosqvist, R., and Wolf-Watz, H. (2001) Yersinia YopE is targeted for type III secretion by N-terminal, not mRNA, signals. *Mol Microbiol* **39**: 520-531.
- Luo, Y., Bertero, M.G., Frey, E.A., Pfuetzner, R.A., Wenk, M.R., Creagh, L., Marcus, S.L., Lim, D., Sicheri, F., Kay, C., Haynes, C., Finlay, B.B., and Strynadka, N.C. (2001) Structural and biochemical characterization of the type III secretion chaperones CesT and SigE. *Nat Struct Biol* **8**: 1031-1036.
- Marlovits, T.C., Kubori, T., Sukhan, A., Thomas, D.R., Galan, J.E., and Unger, V.M. (2004) Structural Insights into the Assembly of the Type III Secretion Needle Complex. *Science* **306**: 1040-1042.
- Mavris, M., Page, A.L., Tournebize, R., Demers, B., Sansonetti, P., and Parsot, C. (2002) Regulation of transcription by the activity of the Shigella flexneri type III secretion apparatus. *Mol Microbiol* **43**: 1543-1553.
- Mayer, M.P., and Bukau, B. (2005) Hsp chaperones: cellular functions and molecular mechanism. *Cell Mol Life Sci* **62**: 670-684.
- Menard, R., Sansonetti, P., Parsot, C., and Vasselon, T. (1994) Extracellular association and cytoplasmic partitioning of the IpaB and IpaC invasins of S. flexneri. *Cell* **79**: 515-525.
- Michiels, T., and Cornelis, G.R. (1991) Secretion of hybrid proteins by the Yersinia Yop export system. *J Bacteriol* **173**: 1677-1685.
- Mills, S.D., Boland, A., Sory, M.P., van der Smissen, P., Kerbouch, C., Finlay, B.B., and Cornelis, G.R. (1997) Yersinia enterocolitica induces apoptosis in macrophages by a process requiring functional type III secretion and translocation mechanisms and involving YopP, presumably acting as an effector protein. *Proc Natl Acad Sci U S A* **94**: 12638-12643.
- Montagna, L.G., Ivanov, M.I., and Bliska, J.B. (2001) Identification of residues in the N-terminal domain of the Yersinia tyrosine phosphatase that are critical for substrate recognition. *J Biol Chem* **276**: 5005-5011.

- Mota, L.J., and Cornelis, G.R. (2005) The bacterial injection kit: type III secretion systems. *Ann Med* **37**: 234-249.
- Mota, L.J., Sorg, I., and Cornelis, G.R. (2005) Type III secretion: the bacteria-eukaryotic cell express. *FEMS Microbiol Lett* **252**: 1-10.
- Mueller, C.A., Broz, P., Muller, S.A., Ringler, P., Erne-Brand, F., Sorg, I., Kuhn, M., Engel, A., and Cornelis, G.R. (2005) The V-antigen of *Yersinia* forms a distinct structure at the tip of injectisome needles. *Science* **310**: 674-676.
- Muller, S.A., Pozidis, C., Stone, R., Meesters, C., Chami, M., Engel, A., Economou, A., and Stahlberg, H. (2006) Double hexameric ring assembly of the type III protein translocase ATPase HrcN. *Mol Microbiol* **61**: 119-125.
- Muskotal, A., Kiraly, R., Sebestyén, A., Gugolya, Z., Vegh, B., and Vonderviszt, F. (2006) Interaction of FliS flagellar chaperone with flagellin. *FEBS Lett* **580**: 3916-3920.
- Neumayer, W., Groll, M., Lehmann, V., Antoneka, U., Kahler, S., Heesemann, J., and Wilharm, G. (2004) *Yersinia enterocolitica* type III secretion chaperone SycH. Recombinant expression, purification, characterisation, and crystallisation. *Protein Expr Purif* **35**: 237-247.
- Neyt, C., and Cornelis, G.R. (1999a) Insertion of a Yop translocation pore into the macrophage plasma membrane by *Yersinia enterocolitica*: requirement for translocators YopB and YopD, but not LcrG. *Mol Microbiol* **33**: 971-981.
- Neyt, C., and Cornelis, G.R. (1999b) Role of SycD, the chaperone of the *Yersinia* Yop translocators YopB and YopD. *Mol Microbiol* **31**: 143-156.
- Niebuhr, K., Jouihri, N., Allaoui, A., Gounon, P., Sansonetti, P., and Parsot, C. (2000) IpgD, a protein secreted by the type III secretion machinery of *Shigella flexneri*, is chaperoned by IpgE and implicated in entry focus formation. *Mol Microbiol* **38**: 8-19.
- Norris, F.A., Wilson, M.P., Wallis, T.S., Galyov, E.E., and Majerus, P.W. (1998) SopB, a protein required for virulence of *Salmonella dublin*, is an inositol phosphate phosphatase. *Proc Natl Acad Sci U S A* **95**: 14057-14059.
- Orth, K. (2002) Function of the *Yersinia* effector YopJ. *Curr Opin Microbiol* **5**: 38-43.
- Page, A.L., Sansonetti, P., and Parsot, C. (2002) Spa15 of *Shigella flexneri*, a third type of chaperone in the type III secretion pathway. *Mol Microbiol* **43**: 1533-1542.
- Pallen, M.J., Francis, M.S., and Futterer, K. (2003) Tetratricopeptide-like repeats in type-III-secretion chaperones and regulators. *FEMS Microbiol Lett* **223**: 53-60.
- Parsot, C., Hamiaux, C., and Page, A.L. (2003) The various and varying roles of specific chaperones in type III secretion systems. *Curr Opin Microbiol* **6**: 7-14.
- Parsot, C., Ageron, E., Penno, C., Mavris, M., Jamoussi, K., d'Hauteville, H., Sansonetti, P., and Demers, B. (2005) A secreted anti-activator, OspD1, and its chaperone, Spa15, are involved in the control of transcription by the type III secretion apparatus activity in *Shigella flexneri*. *Mol Microbiol* **56**: 1627-1635.
- Persson, C., Nordfelth, R., Andersson, K., Forsberg, A., Wolf-Watz, H., and Fallman, M. (1999) Localization of the *Yersinia* PTPase to focal complexes is an important virulence mechanism. *Mol Microbiol* **33**: 828-838.
- Phan, J., Tropea, J.E., and Waugh, D.S. (2004) Structure of the *Yersinia pestis* type III secretion chaperone SycH in complex with a stable fragment of YscM2. *Acta Crystallogr D Biol Crystallogr* **60**: 1591-1599.
- Phan, J., Austin, B., and Waugh, D. (2005) Crystal structure of the *Yersinia* type III secretion protein YscE. *Protein Sci* **14**: 2759-2763.
- Quinaud, M., Chabert, J., Faudry, E., Neumann, E., Lemaire, D., Pastor, A., Elsen, S., Dessen, A., and Attree, I. (2005) The PscE-PscF-PscG complex controls type III secretion needle biogenesis in *Pseudomonas aeruginosa*. *J Biol Chem* **280**: 36293-36300.
- Rimpilainen, M., Forsberg, A., and Wolf-Watz, H. (1992) A novel protein, LcrQ, involved in the low-calcium response of *Yersinia pseudotuberculosis* shows extensive homology to YopH. *J Bacteriol* **174**: 3355-3363.
- Sali, A., Potterton, L., Yuan, F., van Vlijmen, H., and Karplus, M. (1995) Evaluation of comparative protein modeling by MODELLER. *Proteins* **23**: 318-326.
- Sarker, M.R., Neyt, C., Stainier, I., and Cornelis, G.R. (1998) The *Yersinia* Yop virulon: LcrV is required for extrusion of the translocators YopB and YopD. *J Bacteriol* **180**: 1207-1214.
- Sauer, F.G., Knight, S.D., Waksman, G., and Hultgren, S.J. (2000) PapD-like chaperones and pilus biogenesis. *Semin Cell Dev Biol*. **11**: 27-34.

- Schmid, A., Dittmann, S., Grimminger, V., Walter, S., Heesemann, J., and Wilharm, G. (2006) Yersinia enterocolitica type III secretion chaperone SycD: recombinant expression, purification and characterization of a homodimer. *Protein Expr Purif* **49**: 176-182.
- Schoehn, G., Di Guilmi, A.M., Lemaire, D., Attree, I., Weissenhorn, W., and Dessen, A. (2003) Oligomerization of type III secretion proteins PopB and PopD precedes pore formation in Pseudomonas. *Embo J* **22**: 4957-4967.
- Schubot, F.D., Jackson, M.W., Penrose, K.J., Cherry, S., Tropea, J.E., Plano, G.V., and Waugh, D.S. (2005) Three-dimensional structure of a macromolecular assembly that regulates type III secretion in Yersinia pestis. *J Mol Biol* **346**: 1147-1161.
- Shi, J., Blundell, T.L., and Mizuguchi, K. (2001) FUGUE: sequence-structure homology recognition using environment-specific substitution tables and structure-dependent gap penalties. *J Mol Biol* **310**: 243-257.
- Sory, M.P., and Cornelis, G.R. (1994) Translocation of a hybrid YopE-adenylate cyclase from Yersinia enterocolitica into HeLa cells. *Mol Microbiol* **14**: 583-594.
- Sory, M.P., Boland, A., Lambermont, I., and Cornelis, G.R. (1995) Identification of the YopE and YopH domains required for secretion and internalization into the cytosol of macrophages, using the *cyaA* gene fusion approach. *Proc Natl Acad Sci U S A* **92**: 11998-12002.
- Stainier, I., Iriarte, M., and Cornelis, G.R. (1997) YscM1 and YscM2, two Yersinia enterocolitica proteins causing downregulation of yop transcription. *Mol Microbiol* **26**: 833-843.
- Stebbins, C.E., and Galan, J.E. (2001) Maintenance of an unfolded polypeptide by a cognate chaperone in bacterial type III secretion. *Nature* **414**: 77-81.
- Tamano, K., Aizawa, S., Katayama, E., Nonaka, T., Imajoh-Ohmi, S., Kuwae, A., Nagai, S., and Sasakawa, C. (2000) Supramolecular structure of the Shigella type III secretion machinery: the needle part is changeable in length and essential for delivery of effectors. *Embo J* **19**: 3876-3887.
- Thomas, N.A., Deng, W., Puente, J.L., Frey, E.A., Yip, C.K., Strynadka, N.C., and Finlay, B.B. (2005) CesT is a multi-effector chaperone and recruitment factor required for the efficient type III secretion of both LEE- and non-LEE-encoded effectors of enteropathogenic Escherichia coli. *Mol Microbiol* **57**: 1762-1779.
- Tran Van Nhieu, G., Bourdet-Sicard, R., Dumenil, G., Blocker, A., and Sansonetti, P.J. (2000) Bacterial signals and cell responses during Shigella entry into epithelial cells. *Cell Microbiol* **2**: 187-193.
- Troisfontaines, P., and Cornelis, G.R. (2005) Type III secretion: more systems than you think. *Physiology (Bethesda)* **20**: 326-339.
- Tucker, S.C., and Galan, J.E. (2000) Complex function for SicA, a Salmonella enterica serovar typhimurium type III secretion-associated chaperone. *J Bacteriol* **182**: 2262-2268.
- van Eerde, A., Hamiaux, C., Perez, J., Parsot, C., and Dijkstra, B.W. (2004) Structure of Spa15, a type III secretion chaperone from Shigella flexneri with broad specificity. *EMBO Rep* **5**: 477-483.
- Wattiau, P., and Cornelis, G.R. (1993) SycE, a chaperone-like protein of Yersinia enterocolitica involved in the secretion of YopE. *Mol Microbiol* **8**: 123-131.
- Wattiau, P., Bernier, B., Deslee, P., Michiels, T., and Cornelis, G.R. (1994) Individual chaperones required for Yop secretion by Yersinia. *Proc Natl Acad Sci U S A* **91**: 10493-10497.
- Woestyn, S., Allaoui, A., Wattiau, P., and Cornelis, G.R. (1994) YscN, the putative energizer of the Yersinia Yop secretion machinery. *J Bacteriol* **176**: 1561-1569.
- Woestyn, S., Sory, M.P., Boland, A., Lequenne, O., and Cornelis, G.R. (1996) The cytosolic SycE and SycH chaperones of Yersinia protect the region of YopE and YopH involved in translocation across eukaryotic cell membranes. *Mol Microbiol* **20**: 1261-1271.
- Wulff-Strobel, C.R., Williams, A.W., and Straley, S.C. (2002) LcrQ and SycH function together at the Ysc type III secretion system in Yersinia pestis to impose a hierarchy of secretion. *Mol Microbiol* **43**: 411-423.
- Yip, C.K., Finlay, B.B., and Strynadka, N.C. (2005) Structural characterization of a type III secretion system filament protein in complex with its chaperone. *Nat Struct Mol Biol* **12**: 75-81.
- Yuan, M., Deleuil, F., and Fallman, M. (2005) Interaction between the Yersinia tyrosine phosphatase YopH and its macrophage substrate, Fyn-binding protein, Fyb. *J Mol Microbiol Biotechnol* **9**: 214-223.

Plasmids:

pYV derivatives		
Plasmids	Characteristics	References
pYVe227	Wild type pYV plasmid from <i>Y. enterocolitica</i> W227	(Cornelis et al., 1986)
pYV40	Wild type pYV plasmid from <i>Y. enterocolitica</i> E40	(Sory and Cornelis, 1994)
pML4001	pYV40: <i>sycO</i>	This study
pAB406	pYV40: <i>yopO</i> _{Δ65-558}	(Mills et al., 1997)
pSW2276	pYV40: <i>yscN</i> _{Δ169-177}	(Woestyn et al., 1994)
pIML421(ΔHOPEMT)	pYV40: <i>yopH</i> _{Δ1-352} , <i>yopO</i> _{Δ65-558} , <i>yopP</i> ₂₃ , <i>yopE</i> ₂₁ , <i>yopM</i> ₂₃ , <i>yopT</i> ₁₃₅	(Iriarte and Cornelis, 1998)
pCNK4008 (ΔHOPEMNB)	pYV40: <i>yopH</i> _{Δ1-352} , <i>yopO</i> _{Δ65-558} , <i>yopP</i> ₂₃ , <i>yopE</i> ₂₁ , <i>yopM</i> ₂₃ , <i>yopN</i> ₄₅ , <i>yopB</i> _{Δ89-217}	(Neyt and Cornelis, 1999a)

Clones			
Plasmids	Characteristics	Derivation and oligonucleotides used	References
pAB6	pTM100:: <i>yopM</i> ₁₀₀ - <i>cyaA</i> '		Boland et al. 1996
pAB29	pTM100:: <i>yopT</i> ₁₂₄ - <i>cyaA</i> '		Iriarte et al. 1998
pCD10	pTM100 :: <i>yopO</i> ₁₄₃ - <i>cyaA</i> ' (<i>sycE</i> promoter)		Unpublished
pCD11	pTM100 :: <i>yopO</i> ₇₇ - <i>cyaA</i> ' (<i>sycE</i> promoter)	Deletion of the MunI/HindIII fragment in pCD10	Unpublished
pISO56	pBBR1 MCS2:: <i>yopO</i> _{flag} (<i>yopE</i> promoter)	Flag-tag insertion in pMAF60 *3688/3710	This study
pMAF60	pBBR1 MCS2:: <i>yopO</i> (<i>yopE</i> promoter)	Cloning of <i>yopO</i> from pYOB2 3118/3119	This study
pML1	pEGFP(N):: <i>yopO</i>	Cloning of <i>yopO</i> 3394/3395	This study
pML2	pEGFP(N):: <i>yopO</i> _{Δ20-77}	Deletion from pML1 *(3396/3397)	This study
pML3	pEGFP(N):: <i>yopO</i> _{D267A}	Mutation on pML1 *(3484/3485)	This study
pML4	pBBR1 MCS2:: <i>sycO</i>	Cloning of <i>sycO</i> 3266/3271	This study
pML7	pET22:: <i>yopO</i> _{his}	Cloning of <i>yopO</i> 3523/3525	This study
pML8	pET22:: <i>yopO</i> _{Δ20-77 his}	Deletion from pML7 *(3396/3397)	This study
pML9	pET22:: <i>sycO-yopO</i> _{his}	Cloning of <i>sycO-yopO</i> 3524/3525	This study
pML10	pGEX-6p-1:: <i>yopO</i>	Cloning of <i>yopO</i> 3698/3699	This study
pML11	pGEX-6p-1:: <i>yopO</i> _{Δ20-77}	Deletion from pML10 *(3396/3397)	This study
pML12	pGEX-6p-1:: <i>yopO</i> _{D267A}	Mutation on pML10 *(3484/3485)	This study
pML13	pGEX-6p-1:: <i>yopO</i> ₂₀₀	Cloning of <i>yopO</i> ₂₀₀ 3523/3908	This study

pML14	pBAD::sycO	Cloning of <i>sycO</i> 3268/3250	This study
pML15	pCDF::sycO	Cloning of <i>sycO</i> 3268/3271	This study
pML16	pBBR1 MCS2::yopO _{Δ20-77} <i>77 flag (yopE promoter)</i>	Deletion from pISO56 *(3396/3397)	This study
pML17	pGEX-6p-1::yopO ₂₀₋₇₇	Cloning of <i>yopO</i> ₂₀₋₇₇ 4015/4028	This study
pML18	pKS::-250/sycO/+250	Cloning of -250/sycO/+250 3266/3267	This study
pML19	pKS::-250/ΔsycO/+250	Deletion of <i>sycO</i> from pML18 *(3272/3273)	This study
pML26	pEGFP(N)::yopO ₂₀₋₈₀	Cloning of <i>yopO</i> ₂₀₋₈₀ 4134/4079	This study
pML27	pEGFP(N)::yopO ₂₀₋₉₀	Cloning of <i>yopO</i> ₂₀₋₉₀ 4134/4080	This study
pML31	pBBR1 MCS2:: <i>yopO</i> _{143 Δ20-77 -cyaA'} <i>(sycE promoter)</i>	Deletion from pCD10 *(3396/3397)	This study
pML32	pET22::yopH _{his}	Cloning of <i>yopH</i> 4305/4308	This study
pML33	pET22::yopE _{his}	Cloning of <i>yopE</i> 4306/4309	This study
pML34	pET22::yopT _{his}	Cloning of <i>yopT</i> 4307/4310	This study
pML36	pEGFP(N)::yopP	Cloning of <i>yopP</i>	This study
pML37	pEGFP(N)::yopN	Cloning of <i>yopN</i>	This study
pMSK3	pTM100::yopP ₉₉ -cyaA'		Unpublished
pMSLH ₉₉	pTM100::yopH ₉₉ -cyaA'		Sory <i>et al.</i> 1995
pMSL28	<i>yopE</i> ₁₃₀ --cyaA'		Unpublished
pMSLE20	pTM100::yopE ₂₀ -cyaA'		(Sory <i>et al.</i> , 1995)
pSAM10	pEGFP(N)::yopE ₁₋₉₀	Cloning of <i>yopE</i> ₁₋₉₀ 4293/4294	This study
pSAM11	pEGFP(N)::yopH ₁₋₉₀	Cloning of <i>yopH</i> ₁₋₉₀ 4295/4296	This study
pSAM12	pEGFP(N)::yopT ₁₋₁₂₄	Cloning of <i>yopT</i> ₁₋₁₂₄ 4297/4298	This study
pSAM13	pCDF::sycE	Cloning of <i>sycE</i> 4301/4302	This study
pSAM14	pCDF::sycH	Cloning of <i>sycH</i> 4303/4304	This study
pSAM15	pCDF::sycT	Cloning of <i>sycT</i> 4299/4300	This study
pYOB2	pCNR26::yopO <i>(yopE promoter)</i>	Cloning of <i>yopO</i> 471/473	This study

Cloning vectors		
Plasmids	Characteristics	References
pBADmyc-his A	pBAD promoter, high copy	Invitrogen
pBBR1-MCS2	medium-low copy	(Kovach <i>et al.</i> , 1995)
pBluescript II KS (+)		Stratagene
pCDF-Duet	T7 promoter	Novagen
pCNR26	<i>yopE</i> promoter	(Sarker <i>et al.</i> , 1998)

pEGFP-N1	CMV IE promoter	BD Biosciences Clontech
pET22	T7 promoter, <i>lac</i> operator, high copy	Novagen
pGEX-6p-1	<i>pTac</i> promoter	Amersham
pTM100	pACYC184- <i>oriT</i>	(Michiels and Cornelis, 1991)

Suicide Vectors, mutator		
<i>Plasmids</i>	<i>Characteristics</i>	<i>References</i>
pKNG101	<i>ori</i> R6K, <i>mob</i> RK2, <i>strAB</i> , <i>sacBR</i>	(Kaniga et al., 1991)
pML20	pKNG101::-250/ Δ <i>sycO</i> /+250	This study

Oligonucleotides labeled with * were used to delete or mutate domains by inverse polymerase chain reaction, using *Pfu* turbo polymerase (Stratagene).

X. Acknowledgments:

Acknowledgements :

Kerstin
Mes parents
Marraine et Patrick

Jaime Mota
Isabel Sorg
Marc Folcher
Manuela Mally
Hwain Shin
Petr Broz
Laure Journet
Anne Walburger
Paul Troisfontaines
Prof. Guy R. Cornelis
All the lab members
Prof. Shin I. Aizawa
Hideaki Mizusaki
All the Hiroshima lab members
Alexander Titz
Steffi Wagner
Emilio Casanova
David Tropel
Cecile Paroz-Pfaff
Emilie Clement
Jacqueline Stalder
Jelena Vermezovic
Silke Lutzelschwab
Mario Feldman
Marina Kuhn
Beat Christen
Matthias Christen
Assaf Levi
Wanda Dischert
Salvatore San Paulo
Loredana Dana
Michaela Hanisch
Prof. Tom Bickle
Prof. Urs Jenal
Prof. Christoph Dehio
Michel Burcklen
Aurelie Lescoute
Simon Henriet
Julie Mignot
Alexandre Soulard
Nina Entelis
Yvan Tarassov
Piotr Kamensky
Irina Brandina
Olga Kolesnikova
Gilbert Eriani
Frank Martin
Sophie Jaeger
Renaud Geslain
Herve Roy
Prof. Daniel Kern
Michael Blaise
Marc Letzelter
Toulia Bazgoul
Stephane Letzelter
Gregory Peltier
Laurent Rimlinger
Christelle Kremer
Sophie Glad
Robert
Benjamin Schwarz
Boris Marc
Muriel Barthelemy
Sabine Voisin
Patrick Hoenner
Dominique Hoenner
Patrick Wach
Frederic Lemmel
Herve Kindbeiter
Lena Langue
Nicolas Ulmer
Laurence Acker
Sebastien Greder
Clement Trenz
Eglinger Olivier
Mr. George Friedrich
Mr. Bernard Robin
Ab. Aloyse Schaff
And so many others...

Curriculum vitae

Personal informations

Name **Michel LETZELTER**
Address Jungstrasse, 45
4056 – Basel
Phone 076 404 81 04
E-mail Michel.Letzelter@unibas.ch
Nationality French
Date of birth 18.08.78



Education and work experience

Dates *October 2002 – January 2007*
Degree **Ph.D**
Field Molecular Microbiology – Infectious biology
Activities Research activities, scientific communication, supervision and teaching of students, scientific collaboration, publication reviewing
Laboratory Prof. G. R. Cornelis – BIOZENTRUM – University of Basel – Switzerland
Subject Functional study of the Type Three Secretion Chaperones

Dates *November 2006 – December 2006*
Activities **Scientific collaboration.**
Laboratory Prof. S. I. Aizawa – Hiroshima Prefectural University – Japan
Subject Extraction and Purification of the Type Three Secretion apparatus of *Yersinia enterocolitica*.

Dates *September 2001 – August 2002*
Degree **DEA (Diplome d'Etudes Approfondies)**
Field Molecular and Cellular Biology
Laboratory Dr. I. Tarassov, Dr. R. Martin – UMR 7156 / CNRS – Strasbourg – France
Subject Import mechanisms of the 5s rRNA into human mitochondria

Dates *October 2000 – June 2001*
Degree **Maîtrise de Biochimie** mention Biologie Moléculaire
Field Biochemistry, Molecular and Cellular Biology, Genetics
University Université Louis Pasteur – Strasbourg – France

Dates *July – September 2000*
Experience **Trainee**
Field Molecular Biology and Biochemistry
Laboratory Group Daniel Kern – UPR 9002 / CNRS – Strasbourg – France

Publication	Letzelter M , Sorg I, Mota LJ, Meyer S, Stalder J, Feldman M, Kuhn M, Callebaut I, Cornelis GR. <i>The discovery of SycO highlights a new function for type III secretion effector chaperones</i> . EMBO J. 2006 Jul 12;25(13):3223-33
Awards	EMBO Short Term Fellowship 2006 attributed for the scientific collaboration with the laboratory of Prof. S. I. Aizawa.
Posters (First Author)	Biozentrum symposium 2004 , St Chrischona – Switzerland. Swiss Society of Microbiology Congress 2005 , Geneva – Switzerland. FEBS – EMBO advanced lecture course 2005 , cellular and molecular biology of membranes, Cargèse – France. Biozentrum symposium 2005 , St Chrischona – Switzerland.
Talks	EU – MEMBMACS network meetings, 2003 , Konstanz – Germany. “Is Orf155 only the chaperone of YopO?” Hiroshima Prefectural University, 2006 , Shobara – Japan. “SycO and the role of Type Three Effector Chaperones”.
Personal experience	Bacterial Knock-outs, generate mutants by allelic exchange. Amplification (RT-) PCR, gene cloning, western blot analysis. Mutant phenotype characterization using microbiology, molecular and cell biology techniques. Gene expression, complementation, <i>in vitro</i> secretion of virulence effector proteins, cell culture, cell infection, analysis of protein translocation using adenylate cyclase reporter fusion proteins and cAMP quantification, apoptosis assays. Study sub-cellular localisation and co-localization of proteins expressed after transfection or translocated upon infection. Cell fractionation, Immunostaining, Fluorescence microscopy, Confocal microscopy. Purification of native or tagged proteins and complexes. Gene expression, FPLC. Demonstration of intermolecular interactions, and stoichiometry determination of proteins complexes. Analytical size exclusion chromatography (SMART, Akta), crosslinking, co-immunoprecipitation, pulldown. Analysis of the solubility of proteins and protein complexes. SMART, ultracentrifugation Test the enzymatic (kinase) activity of different mutants and protein complexes. Kinase assays. Extraction and purification of membrane protein complexes. Spheroplasts, membrane solubilization, gradient ultra-centrifugations, electronic microscopy. Work in Safety Class2 laboratory

Teaching **Microbiology Block-kurs der Universität Basel :**
Teaching, supervision and tutorials.
Laboratory supervision and teaching of trainees.

Language
French : native
English : fluent
German : spoken

Jobs
2001 Tele-operator in a call-center (3 months)
[*Orange / Hays-Ceritex / Oberhausbergen / France*]
2000 Laboratory work - Trainee (3 months)
[*Institut de Biologie Moléculaire et Cellulaire / Strasbourg/ France*]
1999 Worker in a factory (1 month)
[*De Dietrich Thermique / Niederbronn/ France*]
1998 Office worker (1 month)
[*Trésor Public / Bitché/ France*]
1997 Guide in a museum of the Maginot line: The Simserhof (3 months)
[*Office du Tourisme / Bitché/ France*]
1996 Work on archaeological site in Israel (1 month)

Hobbies
Climbing, hiking, skiing, music.

References
Prof. Guy R. Cornelis
Biozentrum, Microbiology division
70, Klingelbergstrasse
4056 Basel – Switzerland
E mail : Guy.Cornelis@unibas.ch

Prof. Shin Ichi Aizawa
Department of Life Sciences,
Prefectural University of Hiroshima,
562 Nanatsuka, Shobara, Hiroshima 727-0023 – Japan
E mail : Aizawa@pu-hiroshima.ac.jp

Dr. Luìs Jaime MOTA
Imperial College London,
Centre for Molecular Microbiology and Infection,
Flowers Building, Armstrong Road,
London SW7 2AZ – United Kingdom
E mail : j.mota@imperial.ac.uk

Dr. Ivan TARASSOV
Department of "Molecular and Cellular Genetics"
UMR 7156, CNRS-Université Louis Pasteur, Strasbourg
21, rue René Descartes
67084 Strasbourg – France
E.mail : I.Tarassov@ibmc.u-strasbg.fr